



STAINLESS STEEL LED KITS INDOOR/OUTDOOR IP66

Range of Twilight®66 fittings incorporate LED technology to provide modern, bright, extra low voltage lighting, which is weather resistant to **IP66** (water-tight & dust-tight) for LED fittings and **IP44** for the junction box.

Round Fitting Kits

Colour	Complete Kit Code	Size	Cut Out Size	No of LEDs	mA	Lights per Kit
White	MM19244	30x27mm	24mm	5	18	4
Blue	MM19245	30x27mm	24mm	5	18	4
White	MM18196	40x27mm	32mm	6	18	4
Blue	MM18197	40x27mm	32mm	6	18	4
White	MM19104	70x27mm	55mm	12	32	2
Blue	MM19105	70x27mm	55mm	12	32	2

Each kit includes everything you'll need. Kit contains (applicable to all of the above codes):

- Light fittings in stainless steel housing, each with 5 metres of pre-wired cable.
- 1 x 230/12, 500mA volt plug-in type transformer.
- 1 x master junction box with 10 metres of pre-wired cable.
- Maximum no. of lights per kit: 10.
- **Excludes Daylight Sensor.**

Add On Lights to the above Kits

Colour	Ø 15mm	Ø 30mm	Ø 40mm	Ø 70mm
White	MM19028	MM19248	MM19032	MM19101
Blue	MM19029	MM19249	MM19033	MM19102
Red	-	MM19250	-	-
Green	-	MM19251	-	-

Accessories

Code	Description
MM70028	10 Way Junction Box complete with 5 metre pre-wired cable
LGA120050EP	Transformer 230/12V, 500mA

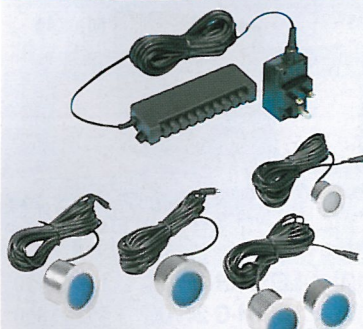

Round Fitting Kit

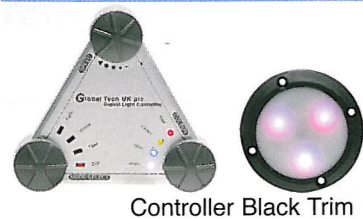
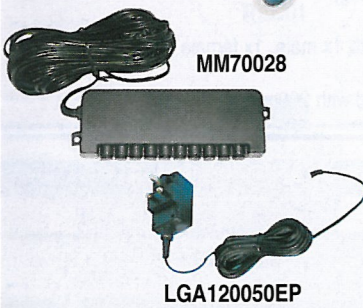

Controller Black Trim

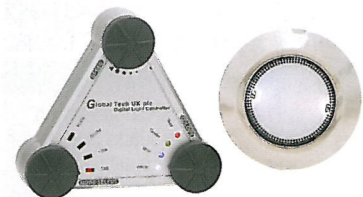

Controller Chrome Trim

Colour	Code	Colour Of Light Trim	Size Ø x H	No per Kit	No of LEDs	Controller Included
• R, • G, • B, • W	GC753MS	Black	75x9mm	4	3	Yes
• R, • G, • B, • W	GC1005MS	Black	100x9mm	4	5	Yes
• R, • G, • B, • W	GC94MS	Chrome	85x9mm	4	5	Yes
• Blue	GC753B	Black	75x9mm	4	3	No
• Blue	GC1005B	Black	100x9mm	4	5	No
• White	GC253W	Black	25x26mm	4	1	No

Each kit includes everything you'll need.

Kit Contains:

- 4 x LED light fittings in chrome or black housing, each with 30cm of pre-wired cable.
- 1 x 230/6 or 7.5 volt plug-in type transformer.
- Controller with 5 metres of pre-wired cable (where indicated).

LED FLOOR TILE LIGHTS IP65

• Material: Ceramic Surface with sealed ceramic base (LEDB5 & B6) • Stainless Steel (LEDB7)

Code	Voltage	Power mA		Size	No of Dots	Material
		R, G, Y, B, W	M (R, G, B)			
LEDB5-*	24VDC	20mA (0.48W)	54mA (1.3W)	100x100x35mm	5	Ceramic
LEDB6-*	24VDC	100mA (2.4W)	180mA (4.5W)	200x200x40mm	16	Marble
LEDB7-*	24VDC	53mA (1.27W)	160mA (3.84W)	200x200x30mm	9	Stainless Steel

*Add colour to code: • R, • G, • Y, • B, • W, • M (R, G, B colour changing)

All Paving Bricks supplied with 2 cables 1 metre long connected with 1x male, 1x female plug.

Power supply to be ordered separately, see page 449.

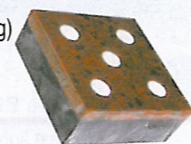
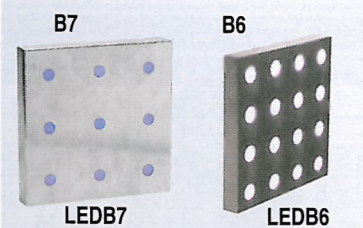

LEDB5

LED LIGHT PANELS

12VDC Standard Power
Supply Voltage: 100-240VAC

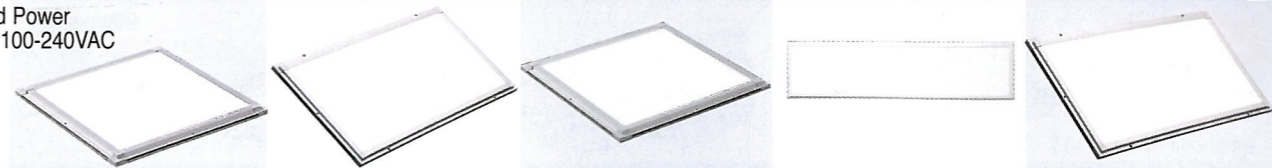

Code	DFL-P0303-*	DFL-P0603-*	DFL-P0606-*	DFL-P1203-*	DFL-P1206-*
Power	17W	34W	38W	38W	75W
Illuminance@1.5m	180lux	600lux	320Lux	250Lux	500Lux
Size (mm)	300 x 300 x 15	600 x 300 x 15	600 x 600 x 15	1200 x 300 x 15	1200 x 600 x 15

*Add colour to code: **PW** (Pure White), **WW** (Warm White)

- Does not produce any harmful UV Rays or Infrared heat. Flicker free lighting that does not produce any RF interference
- Built in constant current LED driver is able to work under unstable supply voltage.
- 5-year life span with special circuit design to avoid the problem of a single faulty LED causing the whole fitting to become faulty
- Any size panel made to order
- Used for dance halls, bars, clubs and other places of entertainment



Any size or colour made to order

LED PANELS

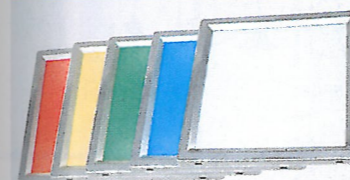

LP-SM-30X30-24V

LED Pane (indoor) IP65

Code	Size	Colour	Watts	Lumen
LP-SM-30X30-24V	300x300x18mm	R, G, B, W	5.76	White 37.8; Red 4.8; Blue 7.4; Green 23.2

Optional Controllers:

- SL-410-2A-24V (8Pcs)
- SRC-171* (50Pcs)

See page 492 for controllers

Function:

The acrylic surface is finished with a frosty effect. The twinkle edge light and reflection is the best illumination for parties. Sized to build up to sizable wall surface. Slim thickness is an additional advantage to energy saving, no maintenance requirement, low heating, etc. Stainless steel casing and simple screw tightening make it very easy to install to any wall or ceiling.

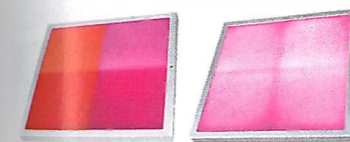

LP-LR-50X50-240V

Code	Size	Colour	Watts	Lumen	Material
LP-LR-50X50-240V	500x500x37mm	R, G, B, W	5.76W	46.2LM	Frosted polycarbonate glass with alum. frame
SRC-SSLIM					Remote Controller to control colour for LED Pane

Optional Controllers:

- SRC-174
- SRC-SSLIM

Function:

- Fixed Colour: Single colour display in red, green, yellow, blue, purple, white and so on.
- Colour change: Seven colour changes; Seven colour flash; Seven colour fade; Colour changing (Quad colour LED Pane)

ADVERTISING PRODUCTS

Changeable LED Illuminated Signs Supplied in kit format 230VAC

Code	Description	Kit Includes:
NRS-004-6-*	150H x 26D (mm) letters	• 103 LED illuminated letters
NRS-004-4-*	100H x 21D (mm) letters	• 4 Sign frames (1200mm long)
		• 2 Power supplies (12VDC, 5A)
		• 1 Vehicle power cable

Letters/Set	Quantity	Letters/Set	Quantity
E	7	B C D	3
A I	6	J K V W Y Z	2
O U	5	Q X	1
L N R S T P	4	0 1 2 3 4 5 6 7 8 9	1
F G H M	3	\$ & ! . %	1
Total letters/Set	103		

*Add colour to code: • R (Red), • Y (Yellow), • GN (Green), • BL (Blue), • W (White)

- Each power supply can power up to 40 letters
- Letter material: acrylic letter lit by internal LEDs
- 1 Vehicle power cable: used to power your message inside the vehicle

Loose Numbers (White)

Code 100mm	Code 150mm
NRS4-*.W	NRS6-*.W

*Add number to code: 1, 2, 3, 4, 5, 6, 7, 8, 9, 0





HIGH POWER LED STREET LIGHTS IP65

NEW



Code (Warm White)	SP90-WW	LU2-WW	LU4-WW	LU6-WW
Code (Pure White)	SP90-PW	LU2-PW	LU4-PW	LU6-PW
Power:	28W	56W	112W	168W
Lumen:	2100Lm	4200Lm	8400Lm	12600Lm
Lamp Base:	E40	Hoop	Hoop	Hoop
Size:	900 x 275L	540L x 315W x 90H	725L x 315W x 90H	890L x 315W x 90H
Weight:	11kg	7kg	10kg	13kg
Illumination:				
Height = 6m	13LUX (20 x 8m)	26LUX (20 x 8m)	53LUX (20 x 8m)	80LUX (20 x 8m)
Height = 8m	7.5LUX (26 x 10m)	15LUX (26 x 10m)	30LUX (26 x 10m)	45LUX (26 x 10m)
Height = 10m	4.5LUX (33 x 13m)	9LUX (33 x 13m)	18LUX (33 x 13m)	28LUX (33 x 13m)
Height = 12m	3LUX (40 x 16m)	6LUX (40 x 16m)	13LUX (40 x 16m)	20LUX (40 x 16m)

Features:

- **Low Power Consumption:** 56W.
- **High Brightness:** Up to 4200 Lumens, 8 times higher than the incandescent lamps.
- **Long Life:** Up to 50000 hours, adopting the PWM constant current power supply, protects the LED's efficiently.
- **Robust Design:** Shock and Vibration resistant.
- **Light Beam:** Low heat generated/No UV, uses an integrated lamp cup & radiator, dissipates heat quickly.
- **Easy Installation:** With the adjustable hoop, which is easy to install on any kind of lamp pole.
- **Save Money:** Reduces labour and maintenance costs.
- **High Efficiency:** Power Factor 90%, THD < 9.
- **Revolutionary Photometric Design:** The world's first dedicated optical system (rectangular beam focusing lens).
- **Unique integrated Lens and Lampshade Design.**
- **No Adverse Glare:** Eliminate the glare caused by the ordinary lights and visual fatigue, improve driving safety, reduce the incidence of traffic accidents, fully embodies the spirit of "people-oriented Technology" in this product.
- **NO Light Pollution:** Light distribution controlled strictly, no light will be scattered out of the designated area.

Technical Details:

- Input Voltage: 85-264VAC
- Frequency Range: 47-65Hz
- Power Factor (PF): >0.9
- Total harmonic Distortion (Thd): <20%
- Power Efficiency: 85%
- LED Luminous Efficiency: 80LM/W
- Lamp's Efficiency (%): >90%
- Colour Temperature: Pure White: 5000-7000K; Warm White: 3000-4000K
- Colour Index (CRI): Ra>75

NEW

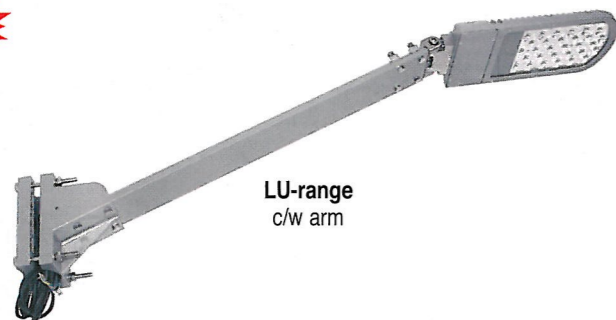

LU-range
c/w arm

Street Lights - High Power Single LED Chip



Code	LU-30W	LU-60W	LU-90W	LU-120W	LU793-60	LU793-100	LU793-120	LU793-140
Light Source	30 x 1W High power LEDs	60 x 1W High power LEDs	90 x 1W High power LEDs	120 x 1W High power LEDs	60W LED Chip	100W LED Chip	120W LED Chip	140W LED Chip
Colour Temperature	6500K ±500K (Daylight)							
Luminous Flux	1550lm	3599lm	4225lm	6075lm	4800lm	8000lm	9600lm	11200lm
Average Illumination	17lux/4m	19lux/6m	16lux/8m	15lux/10m	21lux/6m	20lux/8m	18lux/10m	22lux/10m
Area of Illumination	±6m	±9m	±12m	±15m	±10m	±15m	±18m	±20m
Supply Voltage	100-240VAC	100-240VAC	100-240VAC	100-240VAC	85-265VAC	85-265VAC	85-265VAC	85-265VAC
Total Power	38W	78W	118W	155W	78W	124W	145W	165W
Mounting Height	4m	6m	8m	10m	5-7m	8-10m	8-10m	8-10m
Head Size	380 x 197mm	595 x 283mm	677 x 303mm	712 x 377mm	760 x 360 x 160mm			
Overall Length	1400mm	1818mm	1900mm	1945mm	-	-	-	-

STREET LIGHTING

NEW



Code	ST9001-*	ST9002-*	ST9003-*	ST9012-*	STN007
Supply volts	220-240VAC	220-240VAC	220-240VAC	220-240VAC	220-240VAC
Max Power	150W	250W	400W	250W	250W
Lamp Holder	E27	E40	E40	E40	E40
Material	Body: Die-cast Aluminium	Body: Die-cast Aluminium	Body: Die-cast Aluminium	Body: Die-cast Aluminium	Body: Die-cast Aluminium
	Diffuser: Glass	Diffuser: Glass	Diffuser: Glass	Diffuser: Glass	Diffuser: Glass
IP Rating	IP65	IP65	IP65	IP65	IP65
Size (mm)	530L x 240W x 235H	660L x 340W x 285H	710L x 340W x 285H	660L x 300W x 190H	587L x 288W x 204H

*Add type of switchgear required: MH (Metal Halide), HPS (High Pressure Sodium), EMPTY (No switchgear, for ST9012 only)

SOLAR GARDEN OR STREET LIGHTS

NEW

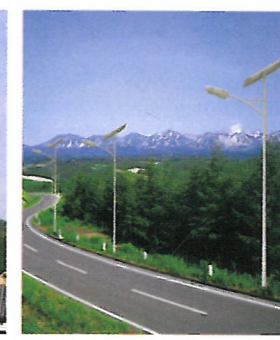

Code	SLS-030	JYSL-8003-AD50	JYSL-8003-AS65	JYSL-8003-DS40	JYSL-8003-FS15
	30W Solar panel. c/w 12V/ 30Ah battery • Lamp 12V 9W LED • Lighting time 8hrs				
		Complete with solar panel, battery and controller. Many different styles are available with various lighting options and battery configurations. Please contact our sales team for more information.			

Accessories

Code	Description
SOL-10/24	10A/ 24V controller
SOL-20/24	20A/ 24V controller
SOL-45/24	45A/ 24V controller

This controller has an advanced light-control function with an incorporated daylight switch. The lights can also be controlled with built-in timer function. This controller is especially suitable for solar powered street lighting systems.

- Battery reverse connection protection
- Overload and short-circuit protection
- Battery open-circuit protection
- Deep discharge and over-charge protection
- Solar panel reverse polarity connection protection
- Back-flow from battery to solar module protection
- Lighting surge protection (in case necessary)
- LCD display



SOL-10/24

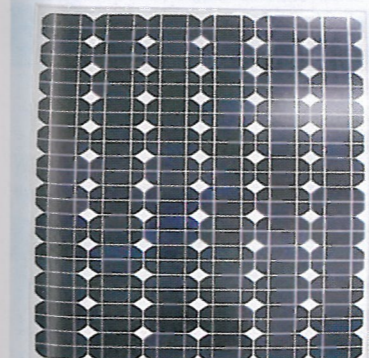

SNP-90W

LU56W-24VDC	LED light 24VDC, cool white(5500K) 28LUX (8m) IP65. Pipe size 60mmØ
SNP-90W	90W Solar Panels. Open circuit Volts 21.6VDC Size: 1185 x 545 x 35mm
SY12080	80AH 12V Rechargeable, maintenance-free battery
BAT-BOX1	Battery Box for 2 x 80AH/12V batteries + solar controller Size: 560 x 410 x 250mm

LU56W-24VDC

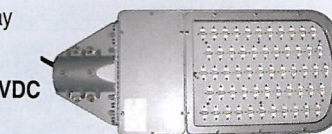

BAT-BOX1



SY12080



LED DC FITTINGS



Code	C2-138	C2-130	C2-116	C2-123-CL2-*	C2-123-CL4-*
Lumen	450lm	250lm	70lm	130lm	240lm
LED colour	Cool White	Pure White	Pure White	Pure White	Pure White
Watts	4 x 1W (4W)	1 x 3W	1 x 1W	2 x 1W (2W)	4 x 1W (4W)
Volts	9-30VDC	9-30VDC	9-30VDC	9-30VDC	9-30VDC
Size (mm)	249 x 108 x 31H	110 x 67 x 41H	115 x 77 x 48H	195 x 30 x 334D	275 x 30 x 33

• On-Night-Off or On/Off rocker switch for power control. • 360° eye-balled rotating light for perfect angle illumination. • 180° rotation flexible light, easy to adjust the angle to meet your requirement • On/Off rocker switch

DC LIGHT FITTINGS

DC Fluorescent Light Fittings For battery installations eg. caravans etc.



Code 12VDC	C2-76 12V	C2-78 12V	C2-89 12V	C2-92 12V	C2-91 12V
Code 24VDC	C2-76 24V	C2-78 24V	C2-89 24V	C2-92 24V	-
Lamp Type	T5	T5	T8	T8	T5
Watts	1 x 8W (FLT5-8)	2 x 8W (FLT5-8)	1 x 10W (FLT8-10)	1 x 15W (FLT8-15)	1 x 8W (FLT5-8)
Size (mm)	410 x 68 x 35H	410 x 68 x 35H	485 x 65 x 45H	591 x 65 x 45H	340 x 50 x 28H
Colour	White	White	Satin	Satin	White



Code 12VDC	C2-68 12V	C2-95 12V	C2-62 12V	C2-113 12V
Code 24VDC	C2-68 24V	C2-95 24V	C2-62 24V	-
Lamp Type	2G7	2G7	2G7	2D (4 Pin)
Watts	1 x 13W (PL-13-WW)	1 x 9W (PL-9-CW)	2 x 7W (PL-7-CW)	1 X 16W (2D-16-CW)
Size (mm)	254 x 70 x 37.5H	200 x 120 x 40H	186 x 179 x 37H	Ø250 x 47.5mm
Colour	Satin	White	White	Satin

• Function of rocker switch:
1. ON: the lamp is always on
2. OFF: the lamp is always off, no matter if the door is open or closed
3. Door: when the car door is not closed, the lamp is illuminated to gain driver's attention; the lamp is off when the door is closed

LOW VOLTAGE PICTURE LIGHTS

Ideal for steps, interior or exterior courtesy lighting and storage areas



Accessories



LED lamp not included

Code	C2-98-*	C2-104-*	C2-98-B
Supply Volts	12-24VDC	12-24VDC	Chrome bezel for C2-98 for surface mounting
Size (mm)	90L x 24.7W x 14.3H	176L x 24.7W x 14.3H	

*Add colour to code: ● R (Red), ● BL (Blue), ● Y (Yellow), CW (Cool White)

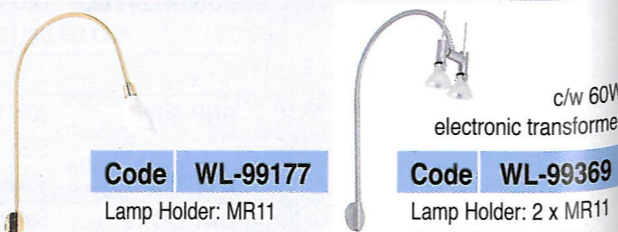

Code WL-99177
Lamp Holder: MR11
Supply Volts: 230VAC
Power: 20W Max
Size: 290mm (H)

Code WL-99369
Lamp Holder: 2 x MR11
Supply Volts: 230VAC
Power: 2 x 20W Max
Size: 290mm (H)

c/w 60W electronic transformer

LED LIGHT FITTINGS

Supply Voltage: 100-240VAC
Material: Aluminium



To accommodate GU10 LED Lamp Max. 7W LED

Desk Lamps



Code	EL202724-DL	LS0617-*	L050A-*	LED-4430	DEL-722	DEL-702	DEL-801
Size (mm)	474(L) x 33Ø	350 X 32Ø	390 X 31Ø	260 X 30Ø	815(H) x 133(W) x 225(D)	510(H) x 50(W) x 235(D)	490(H) x 450(W) x 420(D)
Lumen	90lm	90lm	90lm	-	120lm	120lm	90lm
LEDs	1W	1.2W	1W	GU10 7W	48pcs (3W)	48pcs (3W)	36pcs (2W)
Colour	Daylight only	*Add colour to code: DL (Daylight), WW (Warm White)		Lamp Excl.	White (6000K)	White (6000K)	White (6000K)

DISPLAY/ POP-UP STAND LIGHTS



Lamps not included.

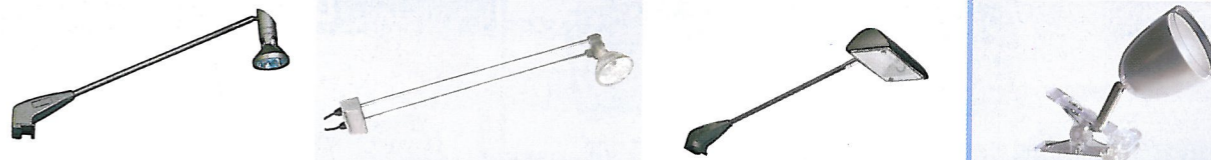

Code	E2-DL-003	E2-DL-004	E2-DL-006	Code	DEL-910
Supply Volts	230VAC	12V	230VAC	Size (mm)	500 x 380 x 22
Power	50W	50W	150W	Lumen	220lm
Lamp Holder	MR16	MR16	Rx7s (78mm)	LEDs	3W
Arm Length	470mm	370mm	590mm	Colour	Cool White (6000K)

LED SPOTS/ DISPLAY LIGHTS

Supply Voltage: 100-240VAC
Angle 60°

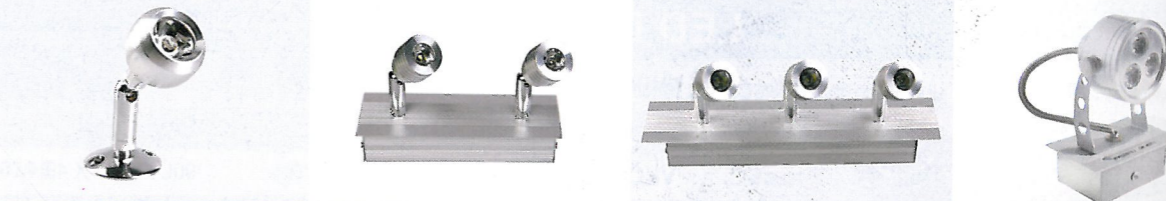

Code	L048B-*	L046A-*	L046C-*	LS0632-*
Size (mm)	78H x 35(Base) x 30Ø	160 x 51 x 112	250 x 61 x 125	88 x 58.5 x 128
Lumen	90lm	180lm	270lm	270lm
LEDs	1 x 1W	2 x 1W (2W)	3 x 1W (3W)	3 x 1.2W(3.6W)

*Add colour to code: DL (Daylight), WW (Warm White)

DISPLAY CABINET LIGHTS

• Excluding Lamp and Transformer • Chrome Plated • Lamp Type MR16 20-50W



Code	CT-3521	CT-3522	CT-3523
Lamp	MR16	MR16	MR16
Size (mm)	55 x 50 H	55 x 100 H	55 x 200 H

LED DISPLAY CABINET LIGHTS

Standard colour: Daylight, 6000K



Code	EL202702-B	EL202702	EL202723
Lamp	1 x 3W	1 x 3W	3 x 1W
Size (mm)	70 Ø x 140 H	70 Ø x 170 H	77 Ø x 425 H
	230VAC	12VAC/DC	230VAC

For electronic transformers, see page 515. For Lamps see page 508.

GRILL LED DOWNLIGHTS

- Direct replacement of the traditional downlight • Beneficial long life, low power, low maintenance and low heat
- High grade housing with convex toughened glass • Constant current (PMW) driver • LED Life: Up to 50,000 hours
- Input Voltage: 90-250VAC • Material: Aluminium cover and Steel housing

NEW



Code	GDL6H-1R*	GDL8H*	GDL12H-2R*	GDL18H*	GDL18H-3R*
Size (mm)	205L x 205W x 112H	205L x 205W x 112H	350L x 205W x 122H	350L x 205W x 122H	500L x 205W x 122H
LEDs	3 x 1W	8 x 1W	12 x 1W	18 x 1W	18 x 1W
IP Rating	IP62	IP62	IP62	IP62	IP62
Material	Aluminium Cover and Steel Housing				
Lumen	312lm/8W	416lm/12W	624lm/17W	1000lm/24W	1000lm/24W

*Add colour to code: ○ CW (Cool White), ○ WW (Warm White)



Code	GDL24HS*	GDL30H*
Size (mm)	382L x 382W x 128H	500L x 205W x 122H
LEDs	24 x 1W	30 x 1W
IP Rating	IP50	IP62
Material	Aluminium Cover and Steel Housing	
Lumen	1248lm/33W	1560lm/24W

*Add colour to code: ○ CW (Cool White), ○ WW (Warm White)

LED SPOTLIGHT

NEW



Aluminium LED Spotlight

Code **RS-SLO4W-03D***

Supply Volts: 85-265VAC

LED Power: 3 x 1W (3W)

Lumen: 280lm

Beam Angle: 30°

Power (Total): 4.5W

*Add colour to code: ○ CW (Cool White),
○ WW (Warm White), ● ● RGB (Red/
Green/Blue)

LED DOWNLIGHTS

NEW



Aluminium Downlights - 85-265VAC

Code	Lumen	LED	Size (mm)	Cutout Size
VKC-50*	244lm	3W	90L X 90W X 49H	1 x 80mmØ
VKC-51*	450lm	2 x 3W (6W)	175L X 90W X 50H	2 x 80mmØ
VKC-52*	720lm	3 x 3W (9W)	179L X 62W X 25H	3 x 80mmØ

*Add colour to code: ○ CW (Cool White), ○ WW (Warm White)

Supply Voltage:
100-240VAC
Angle 30°

NEW

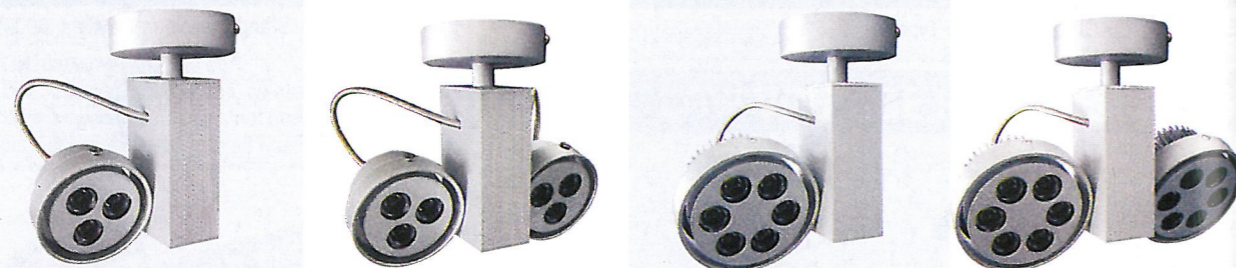

Code	MS-WL003003*	MS-WL003006*	MS-WL004006*	MS-WL004012*
Size (mm)	105L x 55W x 121H	178L x 55W x 121H	123L x 63W x 130H	213L x 63W x 130H
Lumen	180lm	2 x 180lm	360lm	2 x 360lm
LEDs	3 x 1W	6 x 1W (6W)	6 x 1W(6W)	12 X 1W (12W)

*Add colour to code: ○ DL (Daylight), ○ WW (Warm White)

LIGHTING



Ceiling Fittings - 230VAC

Code	Holder	Watts	Description
SPL-026	E27	60W	1x Lamp fitting, white
SPL-027	E27	60W	2x Lamp fittings, white
SPL-030	E27	60W	2x Lamp fittings, white
SPL-023	E27	60W	3x Lamp fittings, white
SPL-029	E27	60W	3x Lamp fittings, white

NB: Only Reflective Lamps R60 to be used, see page 509



Low Voltage Ceiling Fitting

	Round		Bar	
	Satin Silver	White	Satin Silver	White
1 Way	1RP-5410S	1RP-5410W	-	-
2 Way	2RP-5410S	2RP-5410W	2BR-5410S	2BR-5410W
3 Way	3RP-5410S	3RP-5410W	3BR-5410S	3BR-5410W

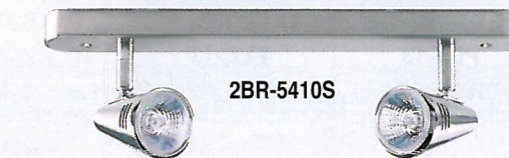

- All supplied complete with 230/12V transformer
- Lamps to be ordered separately, type MR16-50 12V. See page 508

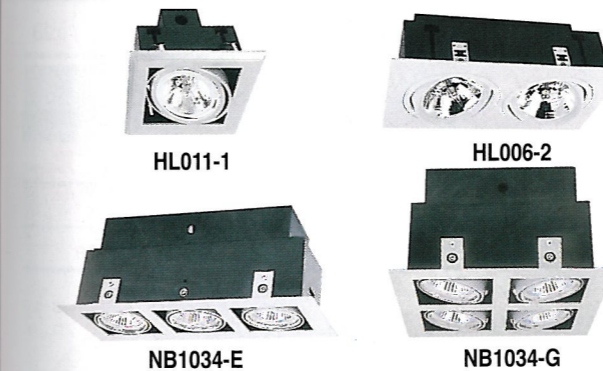

Low Voltage Box Lighting

Code	Watts	Cutout Size (mm) L x W x H
HL011-1 WH	1 x 50W	165 x 165 x 140
HL006-2 WH	2 x 50W	310 x 115 x 135
NB1034-E	3 x 50W	450 x 167 x 135
NB1034-G	4 x 50W	320 x 320 x 135

- All supplied without 230/12V transformer.
- Lamp Holder AR111.
- Excluding lamps (see pages 498, 503 & 510).
- Lamp code AR111-50W
- Colour of frame White.

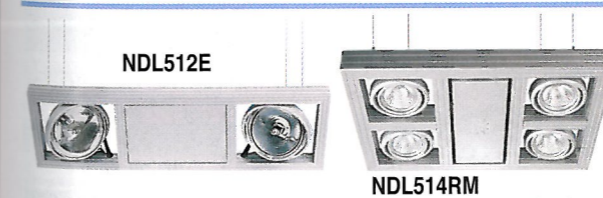

Suspended Multiple Light

Supply Voltage 230VAC

Code	Watts	Watts	Lamp Volts	Dimensions (mm)
NDL512E	2 x 50W	AR111	12VAC	476 x 188
NDL514E	4 x 50W	AR111	12VAC	905 x 188
NDL516E	6 x 50W	AR111	12VAC	1241 x 188
NDL514LM	4 x 50W	MR16	12VAC	620 x 130
NDL514RM	4 x 50W	MR16	12VAC	340 x 240
NDL514LG	4 x 50W	GU10	230VAC	460 x 130
NDL514RG	4 x 50W	GU10	230VAC	240 x 240

- Material: Aluminium
- Adjustable length suspension wires included (max length 1.2m)
- Fittings for low voltage AR111 and MR16 lamps and electronic transformer included.

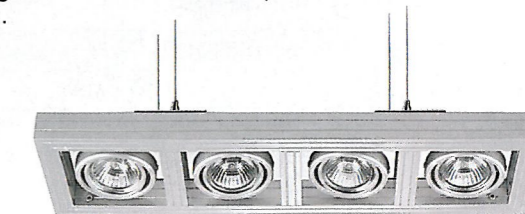
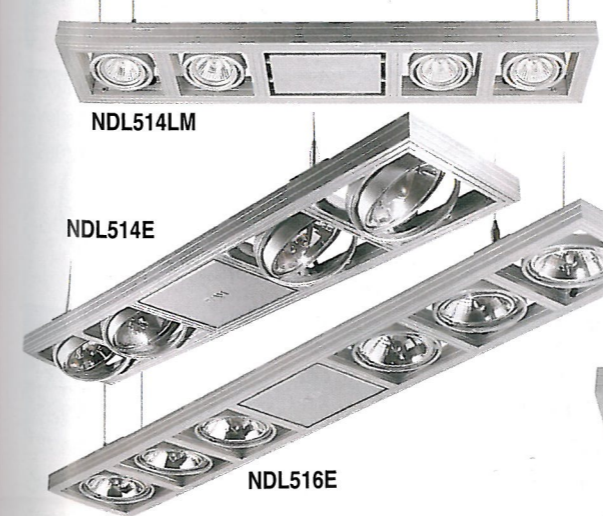

LIGHTING

Indoor & Outdoor Bulkheads IP54

Colour: White
Lamp Type E27
100 Watt max.
Order lamps
separately



Code E27 (100W) Incandescent	NB304001	NB304003	NB304004	NB304005-B (black) NB304005-W (white)	NB304007
Code G24D 2 x 13 Watt Energy Saving Lamps	NB2026	NB2024	NB2025 (1 x 13W)	NB2031 (1 x 13W)	NB2030 (1 x 13W)
Lamp	PLC-13	PLC-13	PLC-13	PLC-13	PLC-13
Size (mm)	240Ø x 125H	240Ø x 120H	240Ø x 125H	285L x 160W x 130H	285L x 160W x 125H

1 x 13W
Energy Saving
Lamp
Order lamps
separately



Code (White)	NB2033	NB2040A	-	-	-	-
Code (Black)	NB2033-BK	NB2040A-BK	NB2035	NB2044	NB2016-S	NB2019-S
Lamp	PLC-13	PLC-13	PLC-13	PLC-13	PLC-13	PLC-13
Size (mm)	235Ø x 120H	270Ø x 90H	235Ø x 120H	282L x 182W x 110H	210L x 145W x 100H	210L x 145W x 100H



Code	CL10021-CH	CL10021-G	CL10022	MB-3002A
Lamp	2D-16-4P	2D-16-4P	2D-28-4P	60W (E27)
Size	270Ø x 90H	270Ø x 90H	320Ø x 90H	310Ø x 65H
Material	PC cover ABS base IP54			Glass cover, Steel base

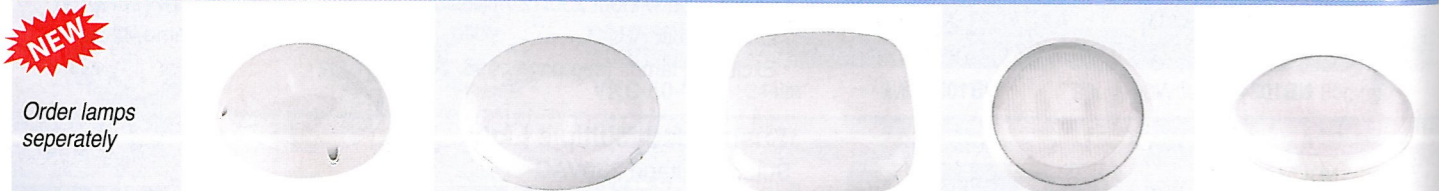

Code	CL10001	CL10002	CL10003	CL10010	CL10018-1
Lamp	2 x PLC-18	2D-28-4P	2D-28-4P	2D-16-4P	2D-28-4P
Size (mm)	340Ø x 115H	300Ø x 102H	302L x 302W x 93H	305Ø x 68H	305Ø x 80H
Material	PC cover ABS base IP54				



Code	WH1039-*	WH1040-*	BK1039-2D	BK1040-2D	WP001
Size (mm)	270Ø x 70H		270Ø x 70H		268Ø x 103H
Lamp	*Add type of lamp to code: 2D (2D16W), 2PL9 (2 x 9PL), E27 (E27 lamp holder), 2D-MS (with microwave motion sensor), 2PL9-MS (with microwave motion sensor built into the fitting. These very sensitive sensors work on the same principle as radar. See page 511 for more information.)		• Black only available in 2D lamp 2D-16-4P		2D-16-4P

Note: All fittings on this page that use 2D lamps use the 4-pin lamp, eg. 2D-16-4P-CW

LIGHTING

NEW Opal Fittings



Clear Fittings



Code	NB250-P	NB280-P	NB210-P	NB250-PCL	NB280-PCL	NB210-PCL
Size	6" PVC Bowl	8" PVC Bowl	10" PVC Bowl	6" PVC Bowl	8" PVC Bowl	10" PVC Bowl
Lamp Holder	B22/PVC	B22/Porcelain	B22/Porcelain	B22/PVC	B22/PVC	B22/Porcelain

NEW



Ceramic CLH22-3-C

Nylon CLH22-3-N

Code	JJ60-B22	Ceramic CLH22-3-C
Lamp/ Watts	Outdoor Fitting	Ceiling lamp batten
Size (mm)	B22/60W Ø90 x 190H	B22/60W Ø105 x 50H

RECTANGULAR BULKHEAD

Mains Luminaires with Electronic Ballast - 230VAC

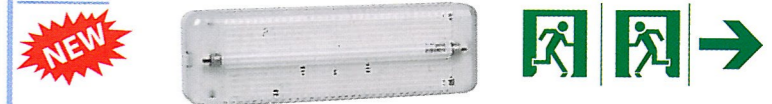

Code	Lamp	Nominal Flux	Emergency Efficiency
GR-124	Fluorescent 8W	350lm	90%
Lamp incl. (cool white). c/w Left/ Right Exit label			

RECTANGULAR BULKHEADS



Code	BH-01	NB2047-B	BK6001	BK6003	FL1057
Lamp	B22/60W	E27	E27	E27	E27
Size (mm)	220 x 105 x 105	245 x 120 x 115	250 x 175 x 116	280 x 175 x 133	330 x 230 x 190
Material	Plastic	Die-cast Al/Plastic	Aluminium/Plastic	Aluminium/Plastic	Aluminium/Glass

NEW LED UP/DOWNLIGHTS IP44



Code	HLH00701-*	HLH00102-*
Base	GX53	GX53
Power	Max. 13W	Max. 2 x 13W
Size (mm)	130 x 110 x 120	110 x 110 x 107
Material	Aluminium Shiny Nickel	Aluminium Shiny Nickel

UP/DOWNLIGHTS IP44



Code	LD3001-56	YF-B5475	DH28330
Base	GU10	2 x G12	2 x E27
Power	50W/CFL	2 x 50W/CFL	2 x 60W/CFL
Size (mm)	150W x 380H	90Ø x 260H	120 x 185 x 400
Material	Aluminium	Aluminium	Aluminium

Lamps excluded, see pages 494-510 for the full range.

STAINLESS STEEL LIGHT FITTINGS

Supply Voltage:
230VAC

NEW

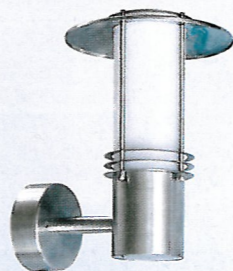
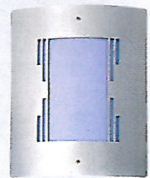

Order Lamps
separately

Code	C300-008	CIE013-A	C300-110	C300-203	KH177AWU
Size (mm)	260W x 220H x 90D	250W x 300H	260W x 235H	225W x 276H	480L x 128 Ø
Lamp	60W/CFL	60W/CFL	60W/CFL	60W/CFL	60W/ CFL
Lamp Holder	E27	E27	E27	E27	E27

S/Steel body with glass diffuser

Supply Voltage:
230VAC

NEW



With day/night sensor

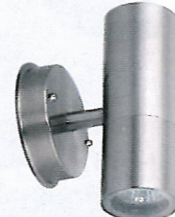

Order Lamps
separately

Code	C300-223	CIE007S	CIE007	CIE052-1	CIE053-1
Size (mm)	380W x 410H	250W x 345H	250W x 345H	117W x 113H x 60Ø	123W x 170H x 60Ø
Lamp	100W/CFL	60W/CFL	60W/CFL	35W	2 x 35W
Lamp Holder	E27	E27	E27	GU10	GU10

Supply Voltage:
230VAC

NEW

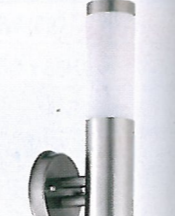
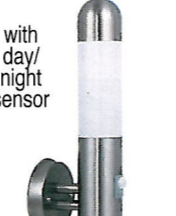
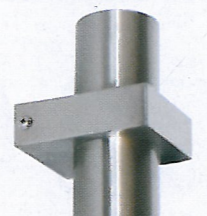
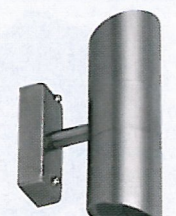

with day/
night
sensor

Order Lamps
separately

Code	CIE053-3	CIE053-4	CIE0030	CIE0022	CIE008S	CIE018
Size (mm)	210W x 120H x 60Ø	120W x 205H x 60Ø	100W x 155H x 60Ø	90W x 162H x 60Ø	165W x 430H x 60Ø	150W x 390H x 76Ø
Lamp	2 x 35W	2 x 35W	2 x 35W	2 x 35W	60W/CFL	60W/CFL
Lamp Holder	GU10	GU10	GU10	GU10	E27	E27

Supply Voltage:
230VAC

NEW

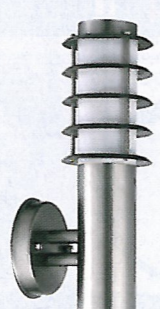
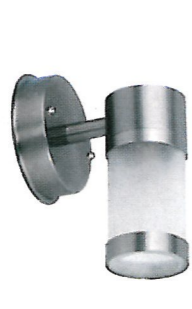
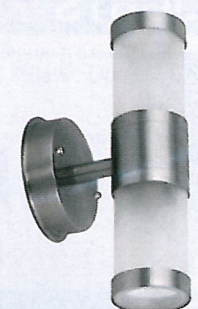

IP44

Aluminium Shiny
Nickel

IP44

Aluminium Shiny
Nickel

Order Lamps
separately

Code	CIE053-G	CIE052-G	CIE019	CIE015	CT-3721A	CT-3722
Size (mm)	120W x 250H x 63Ø	162W x 120H x 104Ø	165W x 390H x 120Ø	395W x 120Ø	130 x 110 x 120	110 x 110 x 107
Lamp	2 x 25W	1 x 25W	60W/CFL	60W/CFL	11W	11W
Lamp Holder	G9	G9	E27	E27	GX53	GX53

For GX53 lamps see page 505

ALUMINIUM WALL MOUNT SPOT LIGHTING IP55

Supply Voltage:
230VAC

Colour:
Grey, Frosted
PVC

Lamps Excluded

NEW

65Ø

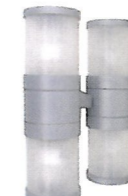

90Ø

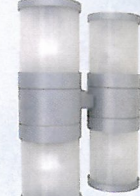
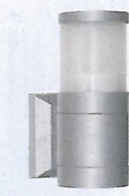

Code	S72601	S72801	S7901	S72603	S72803	S7903
Size (mm)	170H x 117W	280H x 117W	235H x 100W	190H x 140W	290H x 157W	265H x 130W
Power/Lamp	40W/E27	2 x 40W/E27	4 x 40W/E27	40W/E27	2 x 40W/E27	4 x 40W/E27

Supply Voltage:
230VAC

Colour:
Grey, Frosted
PVC

Lamps Excluded

NEW

90Ø

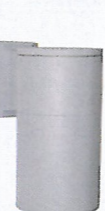

108Ø

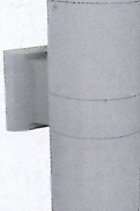
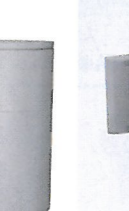

120Ø

Code	S72204	S72202	S72403	S72203	S72201	S72404	S8015
Size (mm)	170H x 157W	260H x 157W	100H x 130W	190H x 17(W)	300H x 173W	100H x 140W	350H x 173W
Power/Lamp	40W/E27	2 x 40W/E27	2 x 50W/G9	40W/E27	2 x 40W/ E27	2 x 50W/G9	2 x 40W/E27

Supply Voltage:
230VAC

Lamps Excluded

NEW

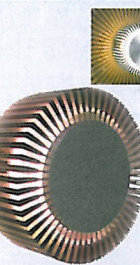
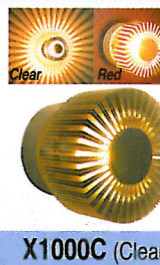

X1000C (Clear)

Code	B2000A	B2000B	X1003D	X1001D	X1000R (Red)	X1000L
Size (mm)	268H x 90W x 120D	148H x 63W x 110D	125H x 105Ø	160H x 170Ø	85D x 90Ø	85D x 140Ø
Power/Lamp	2 x 50W/GU10	2 x 50W/GU10	40W/G9	100W/E27	25W/G9	50W/G9

Supply Voltage:
230VAC

Lamps Excluded

NEW

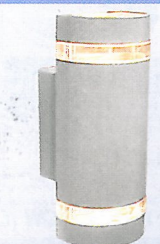
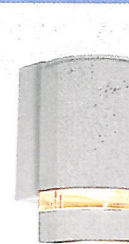
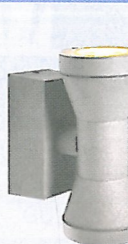
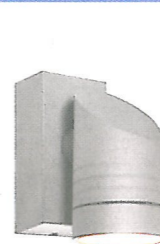

Code	B2004F	B3001	B3105	B6400A	B6400B	B6200
Size (mm)	230H x 110D x 65Ø	111H x 133D x 65Ø	170H x 79Ø	155H x 104D	236H x 104D	220H x 98Ø
Power/Lamp	11W/E27	50W/GU10	2 x 50W/GU10	50W/GU10	2 x 50W/GU10	2 x 50W/GU10

Supply Voltage:
230VAC

Lamps Excluded

NEW

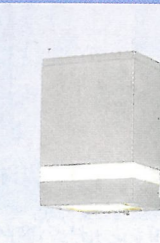
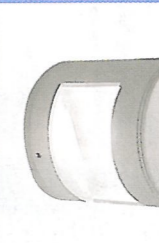
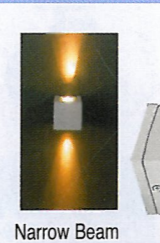
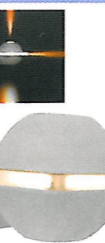

Narrow Beam

Wide Beam

Code	X2000	X1002B-N	X1002B-W	B5300A	NY6051
Size mm	155D x 130Ø	150D x 80L	150D x 80L	120D x 108Ø	150H x 102W
Power/Lamp	50W/G9	75W/G9	75W/G9	25W/G9	50W/GU10



LED STAINLESS STEEL LIGHT FITTINGS IP44

Supply Voltage: 230VAC

NEW

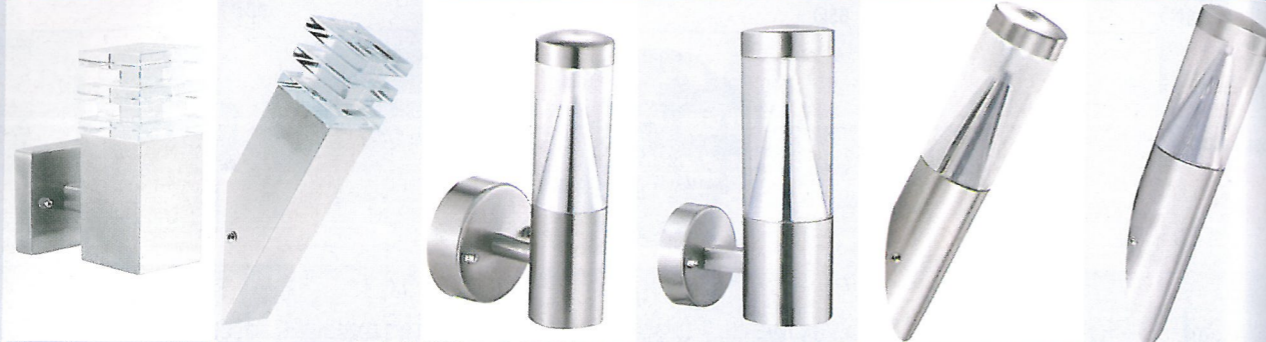

Code	KH839AWU	KH839WU	KH834-SAWU-*	KH834-AWU-*	KH834WU-ADN-*	KH834WU-*
Size (mm)	155H x 120D x 60W	250H x 60D x 60W	109W x 198H x 50Ø	142W x 235H x 78Ø	234H x 50Ø	360H x 78Ø
LED's	16 x 0.12W (1.92W)	16 x 0.12W (1.92W)	16 x 0.12W (1.92W)	16 x 0.12W (1.92W)	9 x 0.12W (1.08W)	16 x 0.12W (1.92W)
Lumen	51.2	51.2	28.8	51.2	28.8	51.2

*Add colour to code: **OW** (White), **BL** (Blue)

Supply Voltage: 230VAC

Colour: White only

NEW

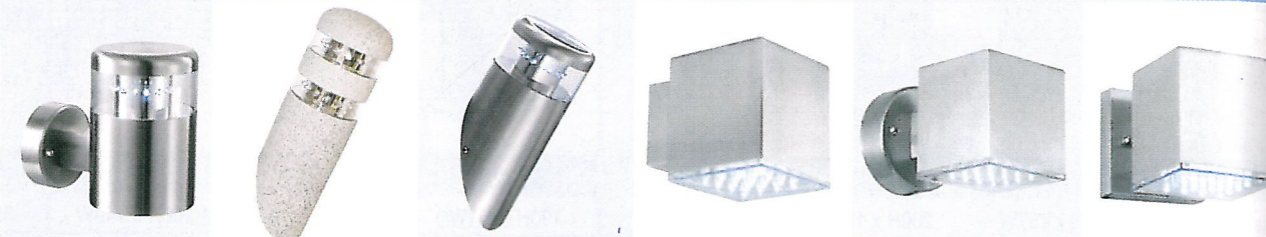

Code	KH838AWU	KH836WU-STONE	KH838WU	KH820-ADN	KH820-BDN	KH820-CDN
Size (mm)	150H x 167W x 101Ø	220H x 76Ø	235H x 10Ø	112W x 90H	145W x 90H	139W x 90H
LED's	16 x 0.12W (1.92W)	24 x 0.12W (2.88W)	16 x 0.12W (1.92W)	16 x 0.12W (1.92W)	16 x 0.12W (1.92W)	16 x 0.12W (1.92W)
Lumen	51.2	76.8	51.2	51.2	51.2	51.2

Supply Voltage: 230VAC
c/w 230/12V Transformer

NEW



Code	KH810-*	KH825-*	KH833S-*	KH834S-*	KH833-*
Size (mm)	260H x 100W x 60Ø	110H x 60Ø	294H x 25Ø	315H x 51Ø	260H x 38Ø
LEDs	9 x 0.12W (1.08W)	9 x 0.12W (1.08W)	2 x 0.12W (0.24W)	3 x 0.12W (0.36W)	3 x 0.12W (0.24W)
Lumen	27	27	6	9	9

* Add colour to code: **OW** (Cool White), **BL** (Blue)

Supply Voltage: 230VAC

NEW

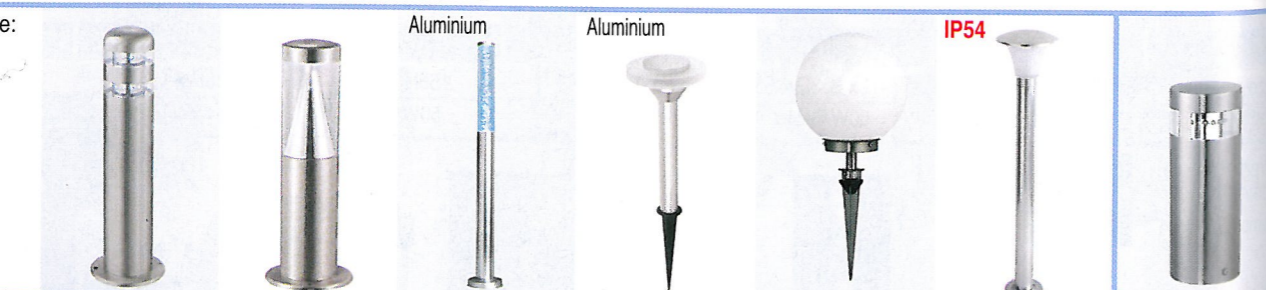

Code	KH836-SS	KH834-PSH	HLC00503	HLD01101	CIE-L003	HLC00201-*	CIE-L006-300-*
Size (mm)	300H x 76Ø	400H x 80Ø	655H x 50Ø	510H x 120Ø	450H x 200Ø	865H x 175Ø	300H x 115Ø
LEDs	24 x 0.12W (2.88W)	16 x 0.12W (1.92W)	15 x 0.08W (1.2W)	18 x 0.06W (1.0W)	2 x 6 x 0.06W	3 x 9W (27W)	16 x 0.06W (0.96W)
Lumen	66	48	45	90	36	138	48

Colour: White only

* Add colour to code: **OW**, **BL**

* Add colour to code: **OW**, **BL**, **OR**, **OGN**, **Y**

STAINLESS STEEL LIGHT FITTINGS

Supply Voltage: 230VAC
Material: PP Plastic & Stainless Steel

NEW

Order Lamps separately



Code	CIE016-600	CIE014S-450	CIE014-450	CIE023	CIE023A-2	KH105
Size (mm)	600H x 76Ø	450H x 76Ø	450H x 75Ø	500H x 60Ø	500H x 60Ø	312H x 90Ø
Lamp	60W/CFL	60W/CFL	60W/CFL	40W	40W	10W -12V
Lamp Holder	E27	E27	E27	G6.35 (G4)	G6.35 (G4)	G6.35 (G4)

Supply Voltage: 230VAC

NEW

Order Lamps separately



Code	CIE007-500	CIE007-1-500	C300-224-650	C300-224	YF-B5207	CIE007-1-1050	CIE007-2H	C300-216
Size (mm)	380H x 410Ø	380H x 410Ø	650H x 200Ø	1175H x 250Ø	800H x 250Ø	1050H x 200Ø	1180H x 200Ø	800H x 120Ø
Lamp	100W/CFL	100W/CFL	60W/CFL	60W/CFL	60W/CFL	60W/CFL	2x60W/CFL	100W/CFL
Lamp Holder	E27	E27	E27	E27	E27	E27	E27	E27
Material	Opal PMMA Plastic & S/Steel	Clear Glass & Stainless Steel	Opal PMMA Plastic & S/Steel	Plastic Globe with Steel base	Clear Glass & Stainless Steel	Opal PMMA & S/Steel	Opal Plastic & S/Steel base	Opal Plastic & S/Steel base

Supply Voltage: 230VAC

NEW

Order Lamps separately



Code	KH147-WU	KH148WU+SEN	KH148AWU	C300-006	KH554	KH553
Size (mm)	195D x 240H	200D x 260H	200D x 360H	270Ø x 100	190Ø x 100	250Ø x 100
Lamp	50W max	50W max	50W max	60W/CFL	60W max	100W max
Lamp Holder	GU10	GU10	GU10	E27	E27	E27

Supply Voltage: 230VAC
IP44

NEW

Order Lamps separately



Code	KH148WU	KH715-BK	KH715	KH715WU-BK	KH715WU	KH246E
Size (mm)	200D x 225H	235D x 445H	235D x 445H	175D x 345H	175D x 345H	345H x 100W
Lamp	50W	60W	60W	60W	60W	60W
Lamp Holder	GU10	E27	E27	E27	E27	E27

S/Steel & Alum body with PC diffuser

LIGHT FITTINGS

Supply Voltage:
230VAC

Lamps
Excluded



Code	NY1836	NY21836R	NY11836R	NY1838	NY3321
Lamp	E27/100W	2 x E27/75W	E27/75W	E27/75W	G4/20W
Size (mm)	84W x 240H	260W x 990H	124W x 990H	175W x 210H	180W x 280Ø

Supply Voltage:
230VAC

Lamps
Excluded



Code	SS-13014	F4018	F4034	F4034-2	JQ703
Lamp	E27/75W	E27/100W	E27/1 x 150W	E27/2 x 150W	E27/26W
Size (mm)	250D x 235H	210W x 260H	115 x 160 x 115	270 x 220 x 115	-

Supply Voltage:
230VAC

Lamps
Excluded



Code	F3125	F4025	F3025-B/G	F3025	F3225-B/G	F3225
Lamp	E27/60W	E27/60W	E27/60W	E27/60W	E27/60W	E27/60W
Size (mm)	346H x 176W	406H x 232W	346H x 176W	346H x 176W	405H x 203W	405H x 203W

Supply Voltage:
230VAC

Lamps
Excluded



Code	LH-5004D	LH-5004H	LH-5004P	LH-5029D	LH-5029H
Lamp	E27/100W	E27/100W	E27/100W	E27/60W	E27/60W
Size (mm)	410W x 260D	1025H x 225W	395H x 225W	475H x 395D	875H x 245W

Supply Voltage:
230VAC

Lamps
Excluded



Code	NY1022-*	NY1592B	NY1001L-*	YF-B5359	YF-B5352	YF-B5319
Lamp	E27/100W	E27/100W	E27/100W	E27/60W	E27/60W	E27/60W
Size (mm)	212W x 336H	245W x 310H	285D x 470H	350H x 165W	285H x 155W	230mmØ

*Add colour of fitting to code: GR (Grey), B/G (Green/Black)

LIGHT FITTINGS

Supply Voltage:
230VAC

Lamps
Excluded

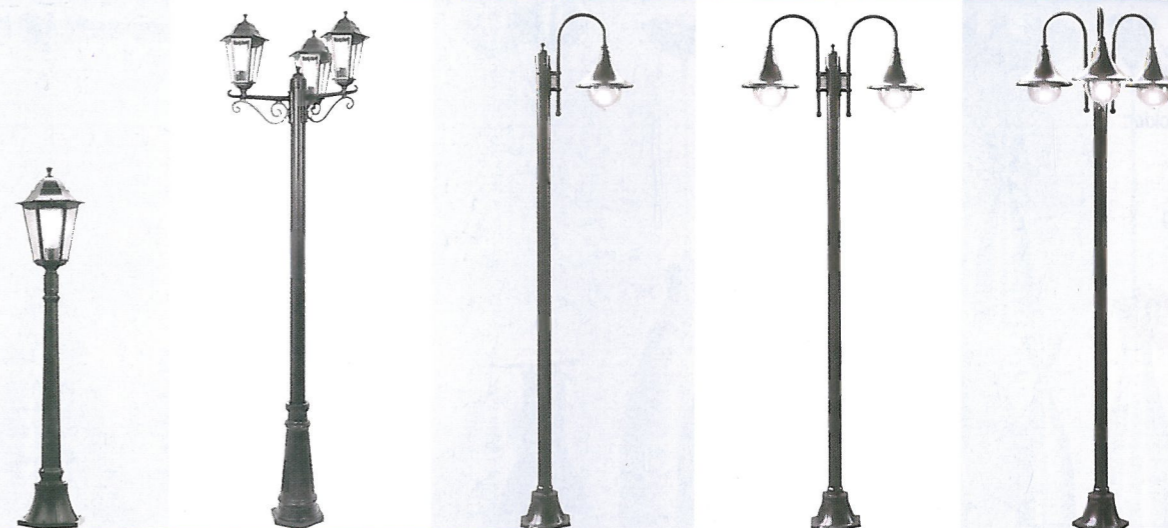

Code	LH-5004G	LH-5004-3G	LH-5029G	LH-5029-2G	LH-5029-3G
Lamp	E27/100W	3 x E27/100W	E27/60W	2 x E27/60W	3 x E27/60W
Size (mm)	1200(H)	2280(H)	2360(H)	2360(H)	2360(H)

Supply Voltage:
230VAC

Lamps
Included

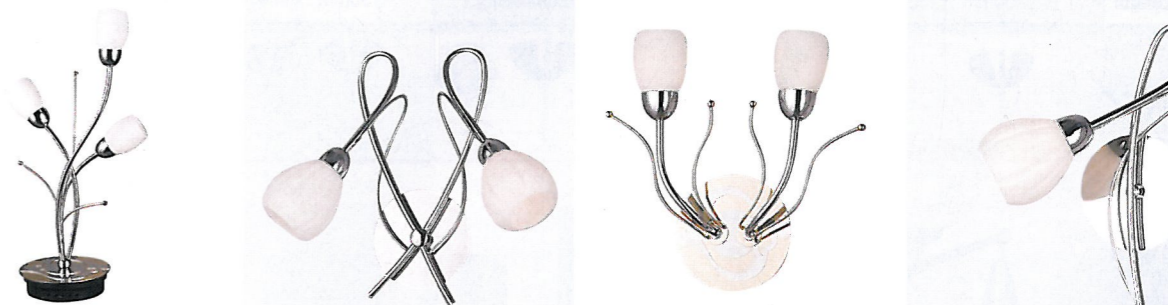

Code	MT09029-3CR	MW09050-2CR	MW09029-2CR	MW09050A-1CR
Lamp	3 x 40W	2 x 40W	2 x 40W	1 x 40W
Base	G9	G9	G9	G9

c/w 230/12V
Transformer

Lamps
Included



Code	MW09055-2CR	MC09055A-5CR	MC09055B-6CR	MC09055-10CR
Lamp	2 x 20W	5 x 20W	6 x 20W	10 x 20W
Base	G4	G4	G4	G4

Supply Voltage:
230VAC

Lamps
Included



Code	MH09027-6AB	MH09050-3CR	MH09050-6CR	MC09050-7CR
Lamp	6 x 40W	3 x 40W	6 x 40W	7 x 40W
Base	G9	G9	G9	G9

ALUMINIUM PENDANT LIGHT FITTINGS

Supply Voltage: 220-250V
Lampholder: E27
Inner Coating Colour: White

NEW



Lamps Excluded

Code	FY-MD-3012-3	FY-MD-3002-3	FY-MD-8018-1	FY-MD-8006-1	FY-MD-3007-3
Total Length	1100mm	1100mm	1000mm	1000mm	1000mm
Fitting Length	250mm	250mm	120mm	130mm	130mm

Supply Voltage: 220-250V
Lampholder: E27
Inner Coating Colour: White

NEW

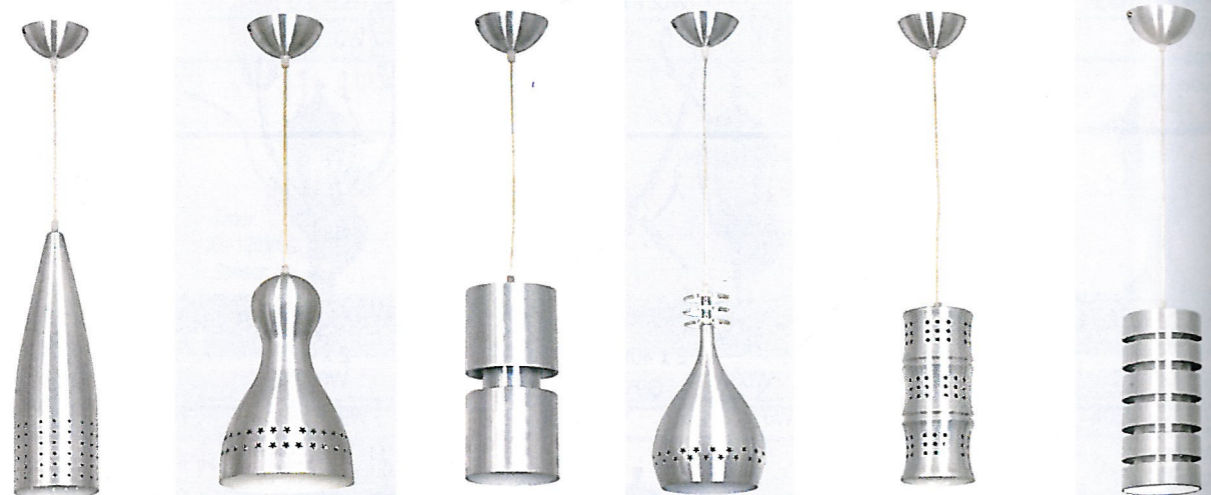

Lamps Excluded

Code	FY-MD-8001-1	FY-MD-3009-1	FY-MD-8023-1	FY-MD-8016-1	FY-MD-3012-1	FY-MD-3005-1
Total Length	1000mm	1000mm	1000mm	1000mm	1000mm	1000mm
Fitting Length	120mm	170mm	120mm	170mm	120mm	110mm

Colour Pendants

Supply Voltage: 220-250V
Lampholder: E27
Inner Coating Colour: Multi-Colour

NEW



Lamps Excluded

Code	FY-MD-3004-3*	FY-MD-3003-1A*	FY-MD-3003-3A*	FY-ML-804	FY-ML-815
Total length	1100mm	1000mm	1000mm	1780mm	1780mm
Fitting Length	260mm	130mm	130mm	-	-

For inner coating colour: *Add colour to code: ● R (Red), ● Y (Yellow), ● BL (Blue), ○ W (White), ● GN (Green)

ALUMINIUM PENDANT LIGHT FITTINGS

Supply Volts: 220-250V

Lampholder: E27

Inner Coating Colour: White

NEW



Lamps Excluded

Code	FY-MD-8010-1	FY-MD-8020-1	FY-MD-8030-1	FY-MD-8004-1	FY-MD-8025-1	FY-010
Total Length	1000mm	1000mm	1000mm	1000mm	1000mm	1250mm
Fitting Length	230mm	180mm	200mm	180mm	320mm	280mm

Supply Volts: 220-250V

Lampholder: E27

Inner Coating Colour: White

NEW

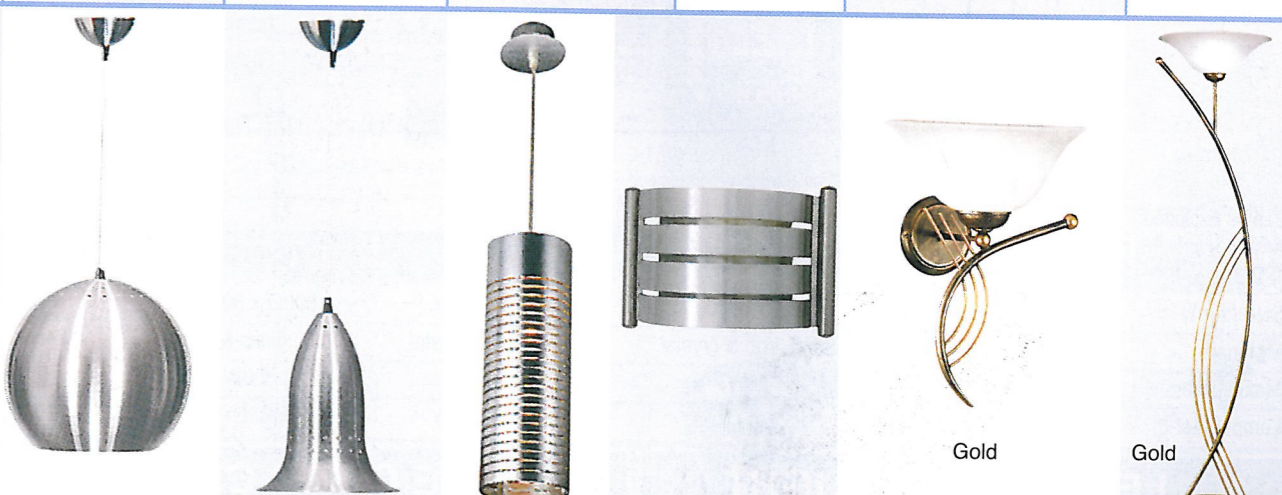

Lamps Excluded

Code	FY-012	FY-013	FY-014	FY-2316	FY-MB-4113/1	FY-ML-4113/2
Total Length	1170mm	1250mm	1000mm	165H x 260L x 140Dmm	390H x 240W x 270Dmm	1750H x 400Ømm
Fitting Length	240mm	280mm	275mm	165mm	390mm	1750mm

Supply Volts: 220-250V

Colour of glass: White

NEW



Lamps Excluded

Code	FY-ML-4101/1	FY-MB-4101/1	FY-MT-4101/1	FY-ML-4112/2	FY-MD-4112/3	FY-MB-4112/1
Size (mm)	1810H	330H x 130D	460H	1650H	170W x 976H x 650L	180H x 240W
Lampholder	1 x E27	1 x E14	1 x E14	2 x E14	3 x E14	1 x E14

CHANDELIERS

NEW

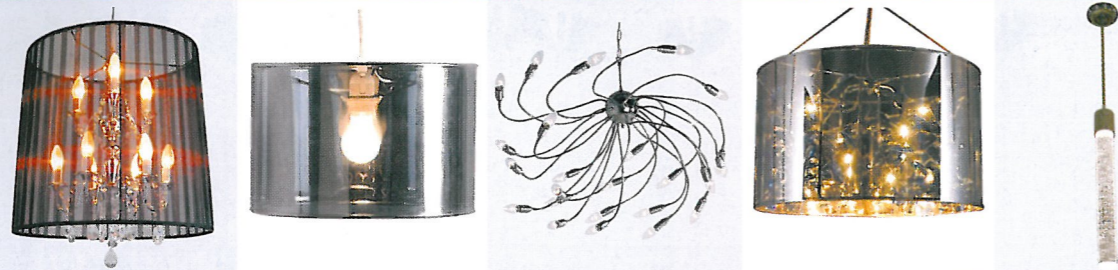

Lamps Excluded

Code	IGLH0050	IGLH0029	IGLH0001	IGLH0054	Y588/1
Size (mm)	550Ø x 525H	345Ø x 230H	1010Ø x 713H	560Ø x 400H	100Ø x 1100H
Material	Organza	Chrome	Chrome	Chrome	Steel, iron & crystal
Max. Power	25W	60W	40W	40W	35W
Lampholder	9 x E14	1 x E27	24 x E14	6 x G9	1 x MR11 (50W)

NEW

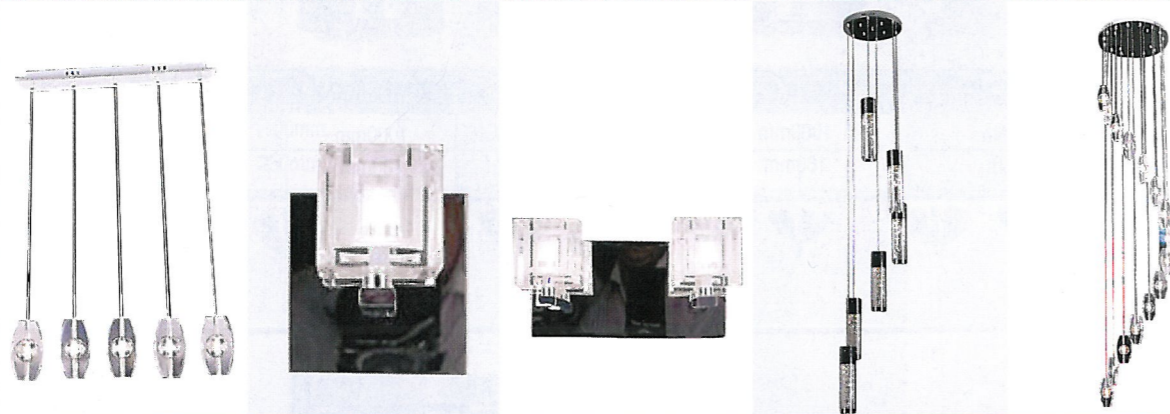

Lamps Excluded

Code	Y643/5A	Y102/1	Y102/2	Y639/6B-Z	Y643/15B
Size (mm)	650Ø x 80W	110 x 110	220 x 110	600Ø x 3000H	600Ø x 2600H
Material	Steel, iron & crystal	Steel, iron & crystal	Steel, iron & crystal	Steel, glass & crystal	Steel iron & crystal
Max. Power	100W	20W	40W	300W	300W
Lampholder	5 x G4 (20W)	1 x G4 (20W)	2 x G4 (20W)	6 x MR16 (50W)	15 x G4 (20W)

LED PENDANT LIGHT

NEW



Lamps Excluded

Code	HKPEN-15W-*
Size (mm)	133Ø x 245H
Material	Aluminium Base and Glass Housing
Max. Power	15 x 1W

*Add colour to code: ○ PW (Pure White), ○ WW (Warm White), ● R (Red), ● BL (Blue), ● GN (Green), ● Y (Yellow)

FIBRE OPTIC CHANDELIERS

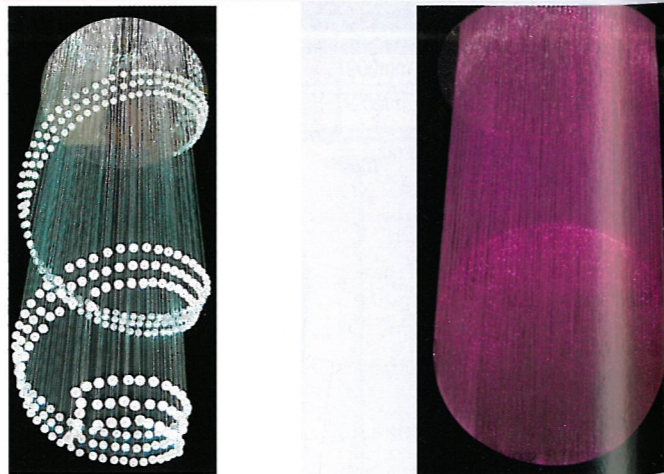

Code	FNL-008	FNL-023
Size (mm)	600Ø x 1600H	1100Ø x 1800H
Material	Weight: 16kg	Weight: 28.5kg
Max. Power	Power: 175W	Power: 336W

c/w 1 Light engine (R-150) and colour wheel

c/w 2 Light engine (R-150 DMX M/S/D) and SRC-144 controller and colour wheel

TRACK LIGHTING

Track

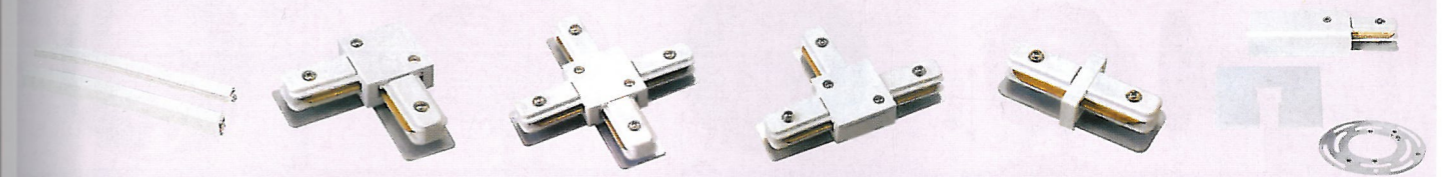

KTK-K	KTK-L	KTK-X	KTK-T	KTK-I	KTK-V
1m track	"L" connector	"+" connector	"T" connector	"I" connector	Supply end + end cap

Adaptors

Extender Poles

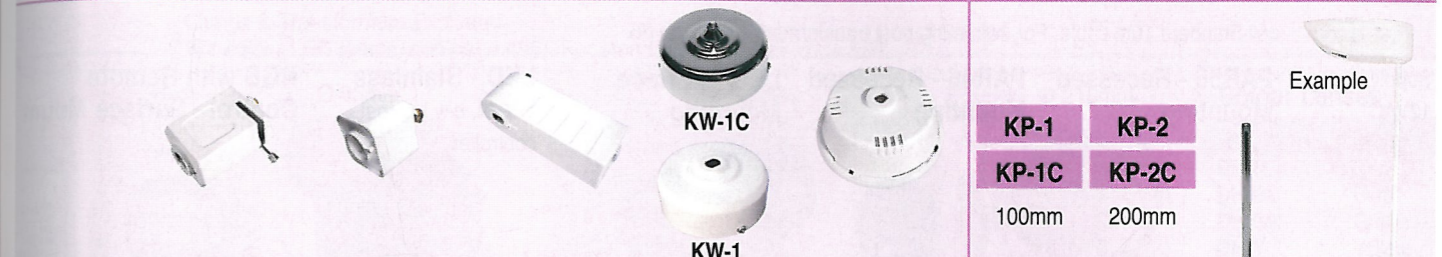

White	KT-1	KT-3	KT-7	KW-1	KW-2	KP-1	KP-2	Example
Chrome	-	-	-	KW-1-C	KW-2-C	KP-1C	KP-2C	
	Direct 230V	Direct 230V	230/12VAC*	230/12VAC*	230/12VAC*	100mm	200mm	
						KP-3	KP-4	
						KP-3C	KP-4C	
						300mm	400mm	

*Complete with transformers

Spot Head



White	KT8010W	KT8011W	KT8015W	KT8005W	KT8020W	KT8019W
Chrome	KT8010C	KT8011C	KT8015C	KT8005C	KT8020C	KT8019C

For Lamps see page 494-496, 508.

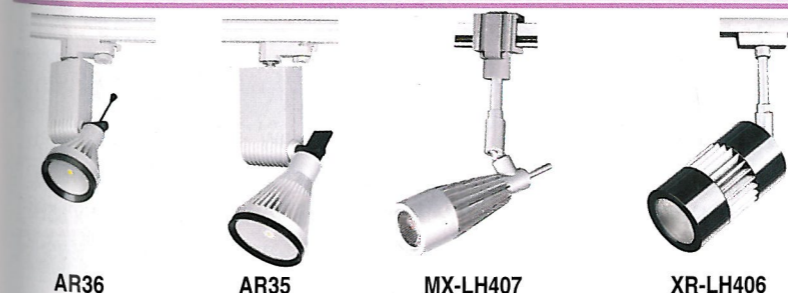

LED Track Lights 230VAC

Code	Description
AR36	5W LED Track Spot Head
AR35	10W LED Track Spot Head
MX-LH407	3W LED Track Spot Head
XR-LH406	3W LED Track Spot Head



Energy Saving Track Lights 230VAC

Code	Description
XR-LH408	E14 9W Track Spot Head
XR-LH409	E14 9W Track Spot Head
XR-LH411	GU10 7W Track Spot Head

POOL LIGHTS

Supply Voltage: 12VAC

Recessed Mounting

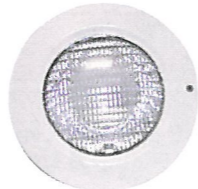

Surface Mount



Code	PL100-10	PL300-10	PLP300-10	PS100-10
Power	100W	300W	300W	100W
Lamp Type	PAR36 (incl.)	PAR56 (incl.)	PAR56 (incl.)	2 X JC (G6.35) (incl.)
Size (mm)	Ø165 x 110	Ø270 x 125	Ø270 x 125	Ø280 x 50
Spare Lamp	Lamp not replaceable	ACL81	ACL81	JC-12-50

c/w Standard 10m cable. For swimming pool transformers, see page 66.

Supply Voltage: 12VAC

PAR56 - Recessed Mounting



PAR46 - Recessed Mounting



LED - Surface Mounting

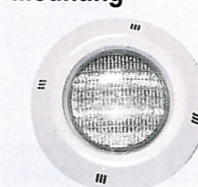

LED - Stainless Steel, c/w internal controller



RGB with Remote Control - Surface Mount



Code	LH-PAR56	LH-PAR46	PAR56-270-CW	CM-P007-M	PAR56-272-RGB
Power	120W/300W (max.)	100W (max.)	15W	12-16W	15W
Lamp Type	PAR56 (not incl.)	PAR46 (not incl.)	LEDs	LED (RGB)	LEDs
Size (mm)	Ø280 x 160	Ø230 x 160	Ø290 x 60	Ø 210mm	Ø290 x 60
Spare Lamp	ACL81 or HG-PAR56 (LED)	ACL46 or HG-PAR46 (LED)	Lamp not replaceable, complete fitting only		

LED PAR 56 & PAR46 Lamp (Suitable for Swimming Pools)



Lumen (MCD):
R & Y=1500-2500
G=7000-9000
B=2000-2500
W=6000-8000
RGB=2000-3500
Supply Volts=12VAC

Code	No of LED's	Power
HG-PAR56*	216	13W
HG-PAR46*	180	10W

*Add colour to code: ● R, ● B, ● G, ● Y, W & ●●● M (RGB)

Remote supplied with M (Multicolour) only

FOUNTAIN LIGHTS IP68

Supply Voltage: 24VDC



Inner hole: Ø46.5mm

Underwater Stainless Steel LED Lights IP68 c/w 6m cable

Code	LEDs	Power	Size (mm)
RW-LED10004*	9 x 1W	9W	160Ø x 35H
RW-LED10004-RGB	9 x 1W	9W	160Ø x 35H
RW-LED10005*	9 x 3W	27W	160Ø x 35H
RW-LED10005-RGB	9 x 3W	27W	160Ø x 35H

* Add colour to code: ○ CW (Cool White), ○ WW (Warm White), ● R (Red), ● Y (Yellow), ● GN (Green), ● BL (Blue)

Fountain LED Lights. IP68 - Material: Die-cast Aluminium. Complete with 230VAC controller.

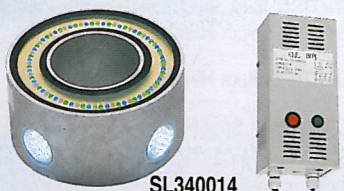

Code	Size (mm)	No of LEDs	Watts	mA	Voltage
SL340014	100Hx200(OD) x100(ID)	90 Top (RGB) LED's 4 x LEDMR16 (18 LED's) 2 x Blue & 2 x White (Side)	12W	510mA	Light 24VDC with controller 230VAC

UNDERWATER LIGHTS IP68

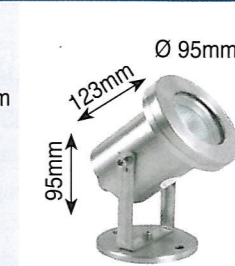
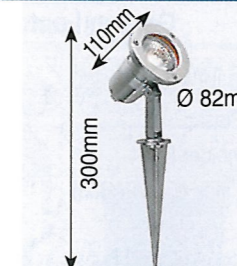
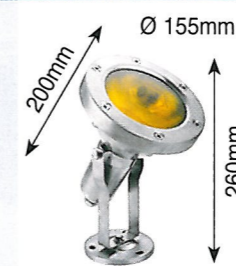

Code	C7062	C7052	C7162	MR16003	LH5001-9A
Lamp	MR16 35W 12V	80W 230V	MR16 35W 12V	MR16 50W	MR16 50W 12V
Lamp Holder	GU5.3	E27	GU5.3	GU5.3	GU5.3
Material	Stainless Steel	Stainless Steel	Stainless Steel	Stainless Steel	PBT

Lamps & Transformers Excluded

For colour LED lamps, see page 496. For standard lamps see page 508.

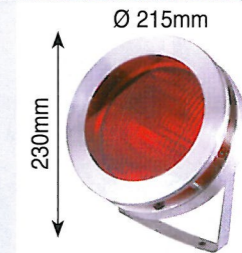

Colour Lenses

Code	Colour
DH-R	Red
DH-BL	Blue
DH-GN	Green
DH-Y	Yellow

Lenses to be ordered separately

Code	LH5001-4	LH5001-3	DH28462
Lamp (excl.)	MR16 50W 12V	PAR 56 300W 12V	PAR56 120-300W 12V
Lamp Holder	GU5.3	Screw Terminals	Screw Terminals
Material	Brass Nickel Plated	ABS	Stainless Steel

Underwater Lights c/w 2 metre cable. IP68



Code	Size	Watts	No of LEDs	Voltage
UD14-M	Ø53mmx35mm	1.5	15	24VAC/DC
UD15*	Ø53mmx35mm	1.5	15	24VAC/DC

*Add colour to code: ● R, ● G, ● B, ● W, ● Y, ● P = Purple (10R + 5B)

LED UNDERWATER LIGHTS IP68

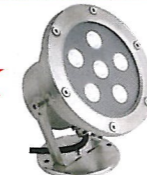

Code	HLB01901-3*	HLB01801-3*	GLD005-3*
Power	6 x 1.0W (6W)	9 x 1.0W (9W)	4.5W
Lumen	276	414	-
Size(mm)	138 Ø x 147(L)	228 Ø x 160(L)	Ø 120mm
Light Distance	6m	9m	-
Material	304 Stainless Steel	304 Stainless Steel	ABS

*Add colour to code: ○ CW (Cool White), ○ WW (Warm White), ● R (Red), ● GN (Green), ● BL (Blue), ● Y (Yellow)

*Add colour to code: ○ W (White), ● R (Red), ● GN (Green), ● BL (Blue), ●●● M (RGB)

GARDEN LIGHTS

Garden LED Egg Shaped Decorative Light Kit IP68

• 3 x Eggs with 1m cable from egg to egg. • Colour: ● R, ● GN, ● BL
• Single Colour or Colour Changing • Complete with Power Supply and 7m cable



Code	Size	Material	Watts	Voltage
SL333115	165x95x85mm	Polyresin	2.7W	Light 24VDC with controller 230VAC

LIGHTING

Garden Lanterns





 <p>Code NB1074</p> <ul style="list-style-type: none"> • ABS Plastic • Lampholder G23 • Lamp: PL-13-CW • IP44 • Lamp included see page 501. 	 <p>Code NB1070</p> <ul style="list-style-type: none"> • ABS Plastic • Lampholder E27 • Lamp: max 80W (PAR38) • IP44 • Lamp excluded, see pages 494, 497, 503, 509. 	 <p>Code EL200660</p> <ul style="list-style-type: none"> • Thermo-Plastic • Lampholder 2 x E27 • Lamp: Max 120W (PAR38) • IP44 • Lamp excluded, see pages 494, 497, 503, 509. 	 <p>Code DH28383</p> <ul style="list-style-type: none"> • Die-Cast Alu body • Lamp E27/ PAR30/ PAR38 (Excl.) • IP65
--	---	--	---

Garden Lights



Code	C500-504	C800-504	C500-510	C500-511	CM-GA003
Lamp	3 x MR11 20W	3 x MR16 20W	ESL	ESL	MR16 35-50W
Lamp Holder	GU4/GZ4	GU4/GZ4	E27/60W or ESL	E27/60W or ESL	GU5.3
Description	Garden Kit consists of: • 3 x Frog Lights c/w Lamp, 1.3m cable and 60VA Transformer, 230/24, with plug. Ready to plug in	Garden Kit consists of: • 3 x Spike Lights c/w Lamp, 2m cable and 60VA Transformer, 230/24, with plug. Ready to plug in	• Excluding Lamp • c/w 400mm cable	• Excluding Lamp • c/w 400mm cable	• Excluding Lamp & Transformer • Suitable for MR16 LED lamps, see pages 494, 496.

LED Garden Lights

 <p>Code LED-3031AS*</p> <p>Size (mm) 350H x 65Ø LEDs 3 x 1W (3W) Lumen 90</p>	 <p>Code LED-9030*</p> <p>Size (mm) 320H x 98Ø LEDs 3 x 1 (3W) Lumen 90</p>	 <p>Code KH836-STONE</p> <p>Size (mm) 306H x 78Ø LEDs 24 x 0.12W (2.88W) Lumen 22</p>	 <p>Code KH342</p> <p>Size: 3 x 300H x 38Ø Lamp: 10W-12V Lampholder: G4</p>
--	---	--	---

*Add colour to code: O CW (Cool White), ● BL (Blue), ● R (Red), ● G (Green), ● Y (Yellow)

Stainless Steel Garden Lights IP44

c/w 230/12V transformer & 3-in-1 connector



Code C7033-ST

Lamp MR16 35W 12V
Lamp Holder GU 5.3
Material Stainless Steel

IN-GROUND LIGHT FITTINGS IP67

Supply Voltage: 230VAC
Excluding lamps.

Code	LED-3605A	CT-3626	CT-3618	CT-3619
Base	LED Lamp (White)	GU10	MR16	MR16
Power	1W	11W CFL	Max. 35W/ 11W CFL	Max. 35W/ 11W CFL
Size (mm)	Ø75 x 100	Ø120 x 145	Ø105 x 140	100 x 100 x 140
Material	Stainless Steel	Stainless Steel	Stainless Steel with Glass Trim	Stainless Steel with Glass Trim

GARDEN LIGHTING IP65







Garden Lights

 <p>Ø97 x H155mm</p> <p>Code NB1036</p> <p>Die-cast Aluminium MR16 12V max 50W (For lamps see page 508)</p>	 <p>Code NB1038</p>	 <p>Code NB1036-B</p>	 <p>Code NB1037</p>	 <p>98x98 x H147mm</p> <p>Code NB1033-A</p> <p>GU10 50W 230V Lamp</p>	 <p>Ø100 x H156mm</p> <p>Code NB1033-D</p> <p>MR16 50W 12V Lamp</p>	 <p>Ø96 x H147mm</p> <p>Code NB1033-B</p> <p>MR16 50W 12V Lamp</p>	 <p>Ø154 x H255mm</p> <p>Code NB1033-C</p> <p>E27 15W max Energy Saving Lamp</p>
---	---	---	---	---	---	--	--

• Stainless Steel body. • Tempered glass.
(For lamps see page 508, 494, 496, 505)

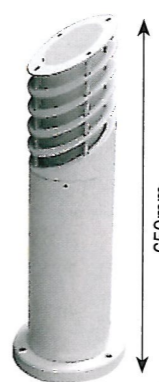
 <p>Ø240 x H290mm</p> <p>Code HF-0311</p> <p>Stainless Steel body Tempered Glass Lamp Holder: Rx7s Metal halide: 150W c/w control gear</p>	 <p>Ø170 x H202mm</p> <p>Code NB1032</p>	 <p>Ø170 x H227mm</p> <p>Code NB1031</p>	 <p>Ø170 x H112mm use lamp AR111-50W</p> <p>Code NB1056</p>	 <p>Ø220 x H300mm</p> <p>Code NB1034-B</p> <p>Stainless Steel Tempered Glass lamp G12 max 70W Supplied without control gear and lamp (For lamps see page 509)</p>	 <p>Pic shown with lamp. Lamp excluded</p> <p>Code NB1057-D</p> <p>Stainless Steel Lamp PAR38 (ACL91) E27 max 75W (For lamps see page 509, 494)</p>
---	---	---	--	--	--

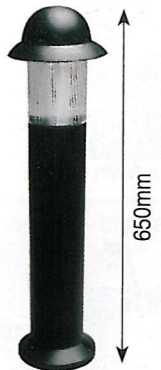
Garden Lamp Posts

 <p>Code NB1051</p> <p>Die-cast Aluminium MR16 12V max 50W IP55 (For lamps see pages 508, 494 & 496)</p>	 <p>Code NB1052</p> <p>Die-cast Aluminium MR16 12V max 50W IP55 (For lamps see pages 508, 494 & 496)</p>	 <p>650mm</p> <p>205mm</p> <p>Code NB3077</p> <p>Die-cast Alu. Body • Lampholder E27 • Lamp max 100W • IP44</p>	 <p>600mm</p> <p>140mm</p> <p>Code DH28201</p> <p>Die-cast Alu. Body • Energy saving lamp/ 7-20W • Lampholder E27 • IP65</p>	 <p>650mm</p> <p>170mm</p> <p>Code NB3078</p> <p>Die-cast Alu. Body • Energy saving lamp • Lamp PL-9-CW • IP44</p>	 <p>373mm</p> <p>Ø 190mm</p> <p>Code NB1049</p> <p>Die-cast Aluminium Body • Lampholder Rx7s • 150W Metal Halide MD-150 • Control Gear to be ordered separately SH150I (page 306) • IP65 Lamps excluded. See page 509</p>
---	---	--	---	--	--

Lamps excluded. See pages 505 and 501

LED SOLAR LAMPS IP67

Plastic Series

Batteries Included

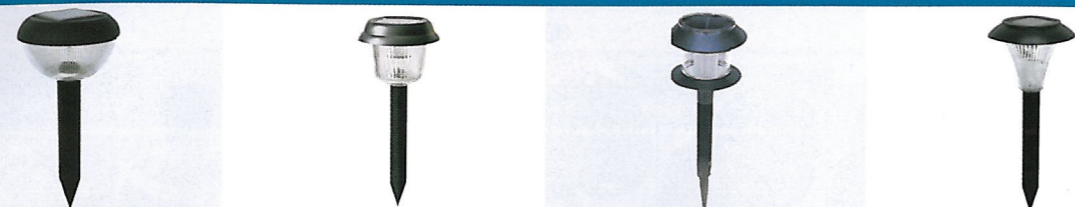

Code IP44	RW-SF-03-8	RW-SF-03-2	RW-SF-02-1	RW-SF-03-4
Size (mm)	320H x 115Ø	455H x 120Ø	605H x 138Ø	325H x 125Ø
Type	1 x LED	1 x LED	1 x LED	1 x LED
Batteries:	1 x NiMh 600mAh	1 x NiMh 600mAh	1 x NiMh 600mAh	1 x NiMh 600mAh

Stainless Steel Series

Batteries Included



Code IP44	RW-SLS004	E2009	RW-SLS001	RW-SLS002	RW-SLS003
Size (mm)	360H x 115Ø	620H x 150Ø	307.5H x 150Ø	480H x 170Ø	365H x 125Ø
Type	1 x LED	1 x LED	1 x LED	1 x LED	1 x LED
Batteries	1 x NiMh 600mAh	1 x NiMh 600mAh	1 x NiMh 600mAh	1 x NiMh 600mAh	1 x NiMh 600mAh

Ground Tile Series

Batteries Included
** battery life: 3 years

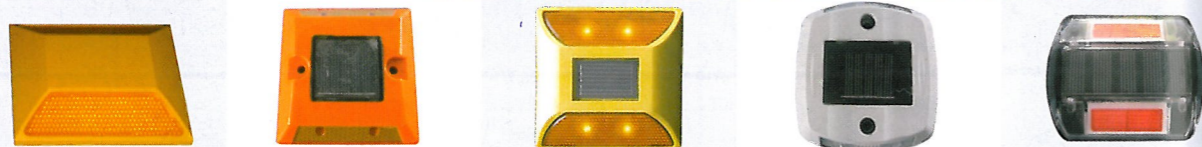

Code	RWSD-012-*	RWSD-006-*	*RWSD-009	RWSD-010	RWSD-011
Size (mm)	100L x 100W x 20H	118L x 115W x 25H	108L x 108W x 18H	140L x 130W x 28H	102L x 82W x 23H
Material	PC	PC	PC	Aluminium	PC
Type	Reflector	4 x LED	4 x LED	4 x LED	4 x LED
Batteries	-	1 x NiMh 700mAh	1 x NiMh 700mAh	1 x NiMh 700mAh	1 x NiMh 700mAh
Flicker Freq.	-	90/min	90/min	90/min	90/min
Duration Time	-	7 day	7 day	7 day	7 day

*Add colour to code: ● Y (Yellow), ● R (Red), ○ W (White) *LED colour: ● Y (Yellow), other colours available on request.

Stainless Steel In-ground Series

Batteries Included
** battery life: 3 years



Code IP44	RW2LED-120	RW3LED-120	RW-SLR001
Size (mm)	120Ø x 350D	120Ø x 350D	120Ø x 350D
Type	2 x white LED	3 x white LED	1 x LED
Batteries	1 x NiMh 600mA	2 x NiMh 600mA	1 x NiMh 600mA

Floating Lamps



Code IP67	RW-SLB003	RW-SLB002	RW-SLP006
Size (mm)	120Ø	160Ø	160D x 85W x 330H
Material	Plastic	Plastic	Plastic
Type	2 x LED	2 x LED	1 x LED
Batteries	1 x NiMh 600mA	1 x NiMh 600mA	1 x NiMh 600mA

Aluminium Paving Lamp



Spot Lamps



EMERGENCY ILLUMINATION

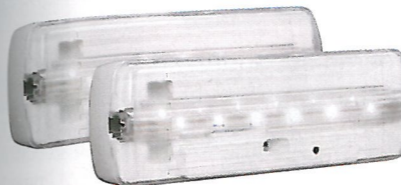
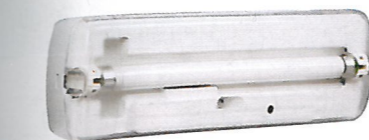

Transparent self-adhesive legends included in pack. Suitable for each direction.

"Slim Light" - Emergency Luminaries - 230V IP20

Codes	Consumption	Battery Ni-Cd	Duration	Lamp	Light Output	Weight
Fluorescent - Non-Maintained						
GR-8	3VA	2.4V/1.5Ah	90mins	6W	50lm	470g
GR-9	3.5VA	2.4V/3Ah	3hrs	6W	50lm	515g
Spare Lamp: FLT5-6						
LED - Non-Maintained						
GR-8/12 LED	3VA	2.4V/1.5Ah	3hrs	12 LEDs	45lm	430g
GR-9/12 LED	3VA	2.4V/3Ah	6hrs	12 LEDs	45lm	460g
Dimensions: 246(L) x 76(W) x 45(D)						

Additional Self-Adhesive Legends (to be ordered separately)



"Professional Light" - Emergency Luminaries - 230V IP20

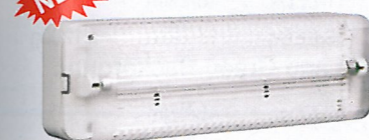

Professional Light



A-1013



Transparent self-adhesive legends included in pack. Suitable for each direction.

Codes	Consumption	Battery Ni-Cd	Duration	Lamp	Light Output	Weight
Fluorescent - Non-Maintained						
GR-110	3VA	2.4V/1.5Ah	90mins	8W	85lm	770g
GR-112	3VA	2.4V/3Ah	3hrs	8W	85lm	870g
Fluorescent - Maintained						
GR-115	23VA	2.4V/1.5Ah	90mins	8W	315/ 85lm	810g
GR-116	24VA	2.4V/3Ah	3hrs	8W	315/ 85lm	920g

C/w Easy Base - for easy installation
Spare Lamp: FLT5-8

Accessories

A-1013 Recess mounting base for wall or suspended ceiling installation.

Additional Self-Adhesive Legends (to be ordered separately)



"Double Easy Light" - Emergency Luminaries - 230V IP42



Transparent self-adhesive legends included in pack. Suitable for each direction.

Codes	Consumption	Battery Ni-Cd	Duration	Lamp	Light Output	Weight
Fluorescent - Non-Maintained						
GR-380	3VA	2.4V/1.5Ah	90mins	8W	85lm	900g
GR-382	4VA	2.4V/3Ah	3hrs	8W	85lm	1000g
Dimensions: 350(L) x 134(W) x 60(H)mm						
Can be mounted onto the ceiling or wall, using special mounting accessories, which are included.						
Spare Lamp: FLT5-8						

Additional Self-Adhesive Legends (to be ordered separately)



LIGHTING

LIGHTING

EMERGENCY ILLUMINATION

NEW

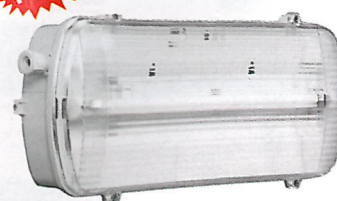

Transparent self-adhesive legends included in pack. Suitable for each direction.

"Weather Light" - Emergency Luminaries - 230V IP65

Codes	Consumption	Battery Ni-Cd	Duration	Lamp	Light Output	Weight
Fluorescent - Non-Maintained						
GR-935	3VA	2.4V/1.5Ah	90mins	8W	85lm	700g
GR-936	4VA	2.4V/3Ah	3hrs	8W	85lm	950g

Dimensions: 355(L) x 160(W) x 72(H)mm

Spare Lamp: FLT5-8

Additional Self-Adhesive Legends (to be ordered separately)



S-93593/S65L

S-93593/S65R

S-93593/S65D

NEW



"Eco Light" - Emergency Luminaries - 230V IP42

Codes	Consumption	Battery Ni-Cd	Duration	Lamp	Light Output	Weight
LED - Maintained Edge Illumination with Green LEDs and Transparent Background						
MLD28/G	7.5VA	3.6/1Ah	3hrs	8 LEDs	18/18lm	500g
MLD34/G	8VA	3.6/1Ah	3hrs	11 LEDs	18/22lm	800g
MLD44/G	8VA	3.6/1Ah	3hrs	13 LEDs	18/22lm	1200g

LED - Maintained Edge Illumination with White LEDs and Green Background

MLD28/W	7.5VA	3.6/1Ah	3hrs	8 LEDs	45/45lm	520g
MLD34/W	8VA	3.6/1Ah	3hrs	11 LEDs	45/55lm	860g
MLD44/W	8VA	3.6/1Ah	3hrs	13 LEDs	45/55lm	1250g

Dimensions: MLD28 280(L) x 100(H) x 75(W)mm
MLD34 340(L) x 170(H) x 75(W)mm
MLD44 440(L) x 220(H) x 75(W)mm

Accessories included:



Includes 2 pairs of special PVC overlays



Accessories

- A-1022 Rigid arms for ceiling installation; 20cm distance
- A-1025 Rigid arms for ceiling installation; 40cm distance
- A-1026 Rigid arms for ceiling installation; 60cm distance
- A-1027 Chains for ceiling installation; 50cm
- A-1018 Recess mounting base for MLD28
- A-1020 Recess mounting base for MLD34
- A-1021 Recess mounting base for MLD44



A-1022/25/26

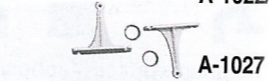

A-1027

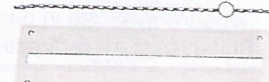

A-1018/20/21

Wall Mount Exit Emergency Light - 230V IP20

Code	Power	Duration	Battery	Size (mm) L x W x H	Auto Switch On Power Failure
DL-623	*2 x 8W	6hrs	6V/4AH	380 x 160 x 90	Yes

*1st Tube for permanent light
2nd Tube for emergency light

Includes 1 x EXIT PVC internal fitted label (DL-5) and battery c/w internal charger

Accessories



DL-5

DL-6

DL-7

SY640 Spare 6V/4AH Battery

FLT5-8

Spare 8W Fluorescent lamp

Hanging installation using the special mounting sets
A-1022 suitable for 20 cm distance
A-1025 suitable for 40 cm distance
A-1026 suitable for 60 cm distance

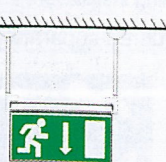

Recessed mounted installation on suspended ceilings using the base type A-1018, A-1020, A-1021



DL-623 c/w exit sign



SY640

EMERGENCY ILLUMINATION

NEW



Code Non-Maintained

B315-18-NM

B201-12L-NM

B207-8L-NM

Code Maintained

B315-18-M

B201-12L-M

B207-8L-M

Lamp

8W T5 Linear Fluorescent

Ø5mm LEDs x 12

Ø5mm LEDs x 8

Mounting

Recessed ceiling mount

Wall Mount

Ceiling Mount

Material

Sheet Steel & Polycarbonate

Aluminium & Acrylate Plastic

Aluminium & Acrylate Plastic

Battery

Ni-Cd (3hrs duration)

Ni-Cd (>2hrs duration)

Ni-Cd (>2hrs duration)

Size (mm)

435L x 150W x 270H

366L x 28W x 162H

382L x 28W x 168H

Signs come as shown above, for different design see the accessories.

NEW

Maintained

Maintained

Non-Maintained

Maintained

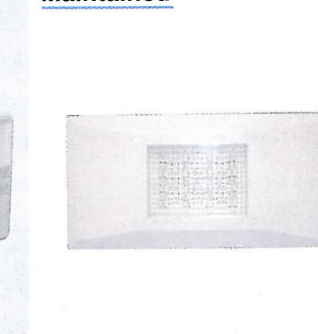
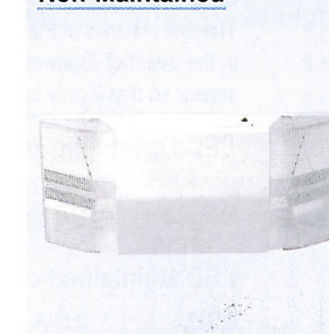
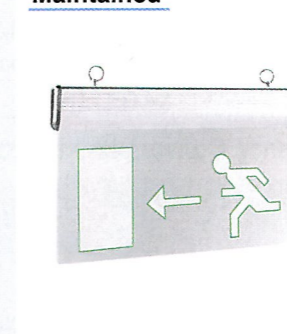

Code

B219-11L-M

B211-8L-M

C502-25HB-NM

LCDJ-L0030

Lamp

Ø5mm LEDs x 11

8 LEDs

Halogen 2 x 5.4W

LEDs

Mounting

Recessed Ceiling Mount

Wall or Ceiling Mount

Wall or Ceiling mount

Wall or Ceiling mount

Material

Aluminium & Acrylate Plastic

Aluminium & Acrylate Plastic

ABS Plastic

Plastic

Battery

Ni-Cd (3hrs duration)

Ni-Cd (3hrs Duration)

Lead-Acid (>2hrs duration)

Ni-Cd (3hrs duration)

Size (mm)

Body: 345L x 15W x 200H
Base: 290L x 65W x 50H

350L x 30W x 235H

300L x 70D x 130W

215L x 23W x 110H

NEW

Maintained - Sign

Maintained - Sign

Maintained IP65

IP65



Side lights come on when power fails

Side light comes on when power fails

Code Non-Maintained

-

-

-

A801-30L-NM

Code Maintained

LCDJ-L0011

LCDJ-L0008

A2D28W-M

A801-30L-M

Lamp

LEDs

LEDs

2D-28W Fluorescent

30 LEDs

Mounting

Wall Mount

Wall mount

Wall or Ceiling Mount

Wall or Ceiling Mount

Material

Plastic

Plastic

Polycarbonate Plastic

Poly Carbonate Base & Diffuser

Battery

Ni-Cd (3hrs duration)

Ni-Cd (3hrs duration)

Ni-Cd (3hrs duration)

Ni-Cd (3hrs Duration)

Size (mm)

344L x 27W x 120H

280L x 27W x 108H

Ø325 x 100

350L x 76D x 117W

Maintained: When mains power is on the light is on
When mains fails the light stays on

Non-Maintained: When mains power is on the light is off
When mains fails the light comes on

EMERGENCY ILLUMINATION

NEW



LED "Spot Light" - Emergency Luminares - 230V IP65

Codes	Consumption	Battery Ni-Cd	Duration	Lamp	Light Output	Weight
LED - Non-Maintained						
GR-90	3VA	3.6V/1.5Ah	3hrs	LED 1W	30lm	500g
GR-95	3VA	3.6V/1.5Ah	3hrs	20 LEDs	65lm	380g
GR-96	3VA	3.6V/1.5Ah	90mins	40 LEDs	130lm	380g

Dimensions: Ø120 x 45mm (hole for flush mount Ø110mm)

- Features**
- The 'Spot Light' series are intelligent emergency luminaries with self-testing functions.
 - They continually test the battery voltage, the high-power LED and the life of the battery.
 - They have a fault output that is activated if one of the tests have failed.

NEW

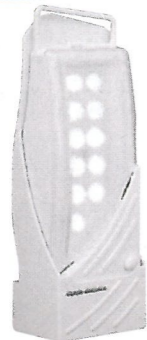

"Home Light" - Portable Emergency Luminares - 230V IP20

Codes	Consumption	Battery Ni-Cd	Duration	Lamp	Light Output	Weight
GR-60	6VA	3.6V/1Ah	≤14hrs	11 LEDs	≤40lm	500g
GR-68	3VA	3.6V/350mAh	≤5hrs	6 LEDs	≤22lm	400g

Dimensions: 228 x 73 x 56 (with base)

The unit consists of the charging base and the main illumination body. The luminaire lights automatically in the event of a power failure or when removed from the base. It has a ON/ OFF switch and a photo sensor so that it only operates at night.

NEW



LED Downlight Emergency Conversion Kit - 230V

Codes	Consumption	Battery Ni-Cd	Duration	For no. of LEDs	Weight
LED Maintained complete with internal battery					
GR-74	3.5VA	12V/ 160mA	≤3hrs	1 LED	250g
GR-76	22VA	12V/ 160mA	45min-3hrs	1-8 Standard & 1-4 Emergency	250g

GR-74 converts one 12V LED downlight to an emergency illumination lamp.

GR-76 can accept up to 8 12V LED downlights in two different circuits. Up to 4 of the lamps can be maintained in event of a power failure. An optional external battery A-951 can be connected to extend duration

Dimensions: 148 x 40 x 31mm

Accessories (optional) For more LED 12V Downlights see page 496.

Codes	Description
A-951	External battery for GR-76 for longer duration (45min-3hrs extra).
GR-88-CW	Cool White LED downlight fits into standard LED fitting. MR16 Base. 12V AC/DC

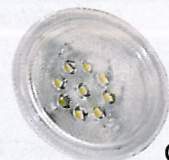

GR-88

Application:

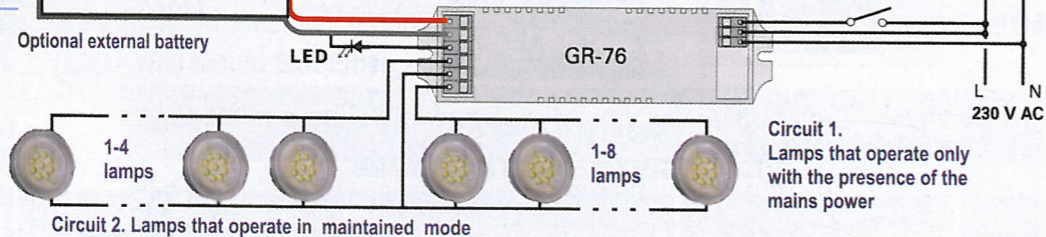

NEW



"Weatherproof Spotlight" - Emergency Luminares IP65

Codes	Voltage	Consumption	Light Source	Light Output
GR-80	230VAC	6VA	9 LEDs	30lm
GR-81	12V AC/DC	100/60mA	9 LEDs	30lm

Flush mounting in junction box or plaster board.

Dimensions: 82 x 82 x 29 to fit standard 3" x 3" box (75 x 75mm)

EMERGENCY LIGHTING IP40

Emergency Lamps

• Complete with battery charger • 230VAC • Charging time 24hrs • Wall mount

Code	Power	Duration	Battery	Size L x W x H	Auto Switch On Power Failure
NB4104	1 x 8W or 2 x 8W	6hrs 3hrs	6V/4AH	430 x 100 x 94	Yes
NB4105	1 x 20W	3.5-4hrs	6V/4AH	730 x 120 x 90	Yes
Complete with Pull Switch					
NB4101	2 x 8W	2-4hrs	Ni-CAD	410 x 90 x 80	Yes

Spares

SY640	6V/4AH Battery	TECO	FLT5-8	8W Fluorescent lamp (T5)
Size:	70 x 47 x 109mm		FLT5-18	18W Fluorescent lamp (T5)



NB4104



NB4105



NB4101

LED EMERGENCY LIGHT FITTINGS IP40

LED Emergency Lamps - Supply Volts 230VAC

• Complete with battery charger • Charging Time: 24 hours

Code	Lumen	Battery	Duration High Light	Size (mm) L x W x H
RWELEDJ-1	102-153lm	6VDC	5 Hours	408 x 85 x 76
RWELEDJ-2	38.4-81.2lm	6VDC	5 Hours	340 x 75 x 75
NS350LX	135lm	4VDC	6 Hours	240 x 60 x 43
NS650LX	270lm	4VDC	4 Hours	395 x 60 x 44
LED008	44lm	4VDC	6 Hours	200 x 55 x 130



RWELEDJ-1



RWELEDJ-2



NS350LX



LED008

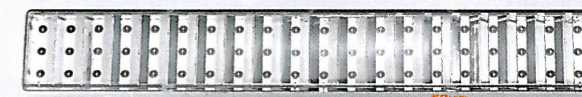

NS650LX

NEW



Emergency Lights

Code	Supply
DX-913	230VAC

Functions

- Automatic operation
- Built-in charger
- Indoor use - IP20

Technical Specs

- Lamps: 2 x 5W 6V
- Battery: 6V/4AH
- Back-up time: 5-6hrs 1 lamp
2.5-3hrs 2 lamps
- Size: 270(H) x 230(L) x 60(D) mm

Spare Lamps

DX-LAMP	5W 6V
---------	-------

Ceiling Mount Exit Emergency Light

• 230V • Both side indicator • IP20

Code	Power	Duration	Battery	Size (mm) L x W x H	Auto Switch On Power Failure
DL-757	*2 x 8W	1.5hrs	6V/1.2AH	410 x 90 x 160	Yes
DL-758S	1 x 8W	1.5hrs	6V/1.2AH	410 x 90 x 160	Yes

*1st Tube for permanent light
2nd Tube for emergency light
DL-757 includes 2 x EXIT acrylic labels (DL-1).
Both models include battery c/w internal charger

Accessories for DL-757

DL-1	DL-2	DL-3
SY612	Spare 6V/1.2AH Battery	FLT5-8
		Spare 8W Fluorescent lamp



DL-757: Ceiling Mount



Side Mount

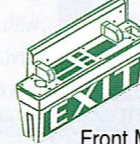

Front Mount



SY612



DL-758S