











NEW

CHORUS MODULAR DEVICES – TITANIUM

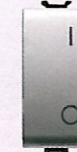
One-Way Switches

 GW14001 1M - 1P - 16AX General	 GW14002 1M - 1P - 16AX Localisation	 GW14021 1/2M - 1P - 10AX General	 GW14022 1/2M - 1P - 10AX Localisation	 GW14031 2M - 1P - 16AX General	 GW14004 1M - 2P - 16AX General	 GW14007 1M - 2P - 25AX Heavy-duty	 GW14034 2M - 2P - 16AX General
--	---	--	---	--	--	---	--

Two-way Switches

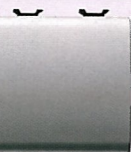
 GW14051 1M - 1P - 16AX General	 GW14052 1M - 1P - 16AX Localisation	 GW14061 1/2M - 1P - 10AX General	 GW14071 2M - 1P - 16AX General
--	---	--	--

Three-Way

 GW14121 1M - 1P - 16AX Positions 1-0-2
--

Reversing

 GW14091 1M - 1P - 16AX General
--

Blanking Modules

 GW14195 1 Gang	 GW14198 2 Gang
---	---

Push-Buttons

 GW14131 1M - 1PN - 16A General	 GW14132 1M - 1PN - 16A Localisation	 GW14136 1M - 1PN - 16A With pull-cord	 GW14161 1/2M - 1PN - 10A General	 GW14171 2M - 1PN - 16A General	 GW14191 2M - 1PN - 10A With illuminated name plate	 GW14040 Universal badge switch 1 gang - NO - 16AX
--	---	---	--	---	--	---



Infrared

 GW14591 IR movement detector 1NA-3A	 GW14592 Infrared movement detector 1NA-16A	 GW12596 Portable 6 channel remote control
--	---	--

Dimmers

 GW14561 Res 100-500W 230VAC	 GW14564 Res 100-900W Ind. 40-300VA 230VAC	 Res 60-500W Ind. 60-500VA 230VAC	 GW14571 Res 40-300W For electronic transformers 230VAC
---	---	---	---

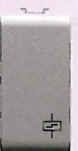
Relays

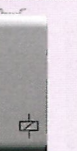
 GW14721 Step-step 1 gang - 10AX 230VAC	 GW14723 4 sequences 2 gangs - 10AX 230VAC	 GW14724 Monostable 1 gang - 1NA NO
---	--	---

Italian

 GW14201 2P+E 10A 250VAC	 GW14203 2P+E 16A 250VAC Dual amperage
---	--

Italian/German

 GW14204 2P+E 16A 250VAC Dual amperage	 GW14205 2P+E 16A 250VAC
---	---

German

 GW14241 2P+E 16A 250VAC

French

 GW14247 2P+E 16A 250VAC

Euro/USA

 GW14287 2P 15A 250/125VAC

British/RSA

 GW14296 2P+E 13A 240VAC

Switched Socket

 GW14297 2P+E 15A 240VAC

Shaving Socket

 GW14321 2P+E 16A 230VAC
--









Shaving Socket

 GW14331 Shower socket/outlet 230VAC - 50/60Hz

NEW

CHORUS MODULAR DEVICES – BLACK

One-Way Switches

 GW12001 1M - 1P - 16AX General	 GW12002 1M - 1P - 16AX Localisation	 GW12021 1/2M - 1P - 10AX General	 GW12022 1/2M - 1P - 10AX Localisation	 GW12031 2M - 1P - 16AX General	 GW12004 1M - 2P - 16AX General	 GW12007 1M - 2P - 25AX Heavy-duty	 GW12034 2M - 2P - 16AX General
--	---	--	---	--	--	---	--

Two-way Switches

 GW12051 1M - 1P - 16AX General	 GW12052 1M - 1P - 16AX Localisation	 GW12061 1/2M - 1P - 10AX General	 GW12071 2M - 1P - 16AX General
--	---	--	--

Three-Way

 GW12121 1M - 1P - 16AX Positions 1-0-2
--







Reversing

 GW12091 1M - 1P - 16AX General
--

Blanking Modules

 GW12195 1 Gang	 GW12199 3 Gang
---	---

Push-Buttons

 GW12131 1M - 1PN - 16A General	 GW12132 1M - 1PN - 16A Localisation	 GW12136 1M - 1PN - 16A With pull-cord	 GW12161 1/2M - 1PN - 10A General	 GW12171 2M - 1PN - 16A General	 GW12191 2M - 1PN - 10A With illuminated name plate	 GW12040 Universal badge switch 1 gang - NO - 16AX
--	---	---	--	--	--	---



Infrared

 GW12591 IR movement detector 1NA-3A	 GW12597 Infrared movement detector 1NA-16A	 GW12596 Portable 6 channel remote control
--	---	--

Dimmers

 GW12561 Res 100-500W 230VAC	 GW12564 Res 100-900W Ind. 40-300VA 230VAC	 GW12568 Res 60-500W Ind. 60-500VA 230VAC	 GW12571 Res 40-300W For electronic transformers 230VAC
---	--	---	---

Relays

 GW12721 Step-step 1 gang - 10AX 230VAC	 GW12723 4 sequences 2 gangs - 10AX 230VAC	 GW12724 Monostable 1 gang - 1NA NO
---	--	---

Italian

 GW12201 2P+E 10A 250VAC	 GW12203 2P+E 16A 250VAC Dual amperage
---	--

Italian/German

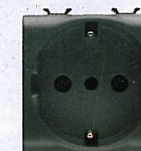
 GW12204 2P+E 16A 250VAC Dual amperage	 GW12205 2P+E 16A 250VAC
--	---

German

 GW12241 2P+E 16A 250VAC

French

 GW12247 2P+E 16A 250VAC

Euro/USA

 GW12287 2P 15A 250/125VAC

British/RSA

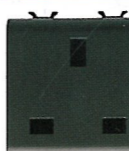
 GW12296 2P+E 13A 240VAC

Switched Socket

 GW12297 2P+E 15A 240VAC

Switched Socket

 GW12321 2P+E 16A 230VAC

Shaving Socket

 GW12331 Shower socket/outlet 230VAC - 50/60Hz

NEW

CHORUS MODULAR DEVICES – BLACK

TV / SAT / FM

Male IEC type
 GW12361 0db
 GW12362 5db
 GW12363 10db
 GW12364 14db
 GW12365 18db
 GW12366 22db
 GW20277 Resistance
 75Ω terminal

Female F type
 GW12371 0db
 GW12372 5db
 GW12373 10db
 GW12374 14db
 GW12375 18db
 GW12376 22db
 GW20277 Resistance
 75Ω terminal

GW12381
 TV - FM
 0db

GW12382
 TV - FM - SAT
 0db

GW12453
 Double RCA

GW12456
 HDMI conn.

USB

GW12457
 USB conn.

Telephone and Communication Connectors

GW12401
 RJ11

GW12402
 RJ11
 In/Out

GW12403
 RJ11
 Double

GW12404
 RJ12

GW12421
 RJ45 5e
 UTP

GW12422
 RJ45 5e
 FTP

GW12423
 RJ45 6
 UTP

GW12424
 RJ45 6
 FTP

GW12441
 SUB - D
 9 contacts

GW12442
 SUB - D
 15 contacts

GW12443
 SUB - D
 25 contacts

Clock

GW12708
 Clock/alarm/
 thermometer
 230VAC - 50/60Hz

Thermostats

GW12703
 Timer thermostat
 230VAC -
 50/60Hz

GW10701
 White wall-mounting
 timed thermostat
GW14701
 Titanium wall-mounting
 timed thermostat

GW12705
 Thermostat
 230VAC -
 50/60Hz

Buzzers and Ringers

GW12606
 Buzzer
 12VAC 50Hz

GW12607
 Buzzer
 230VAC 50Hz

GW12611
 Ringer with three
 independent inputs
 12V AC/DC

GW12612
 Ringer with three
 independent inputs
 230VAC 50Hz

CHORUS ART SWITCH RANGE

WHITE / WHITE SWITCHES

GX01TBA

GX02TBA

GX03TBA

GX04TBA

GX05TBA

GX06TBA

TONER BLACK / BLACK SWITCHES

GX01TNA

GX02TNA

GX03TNA

GX04TNA

GX05TNA

GX06TNA

TITANIUM / TITANIUM SWITCHES

GX01VTA

GX02VTA

GX03VTA

GX04VTA

GX05VTA

GX06VTA

SLATE GREY / BLACK SWITCHES

GX01VAA

GX02VAA

GX03VAA

GX04VAA

GX05VAA

GX06VAA

Also available in:

*Add colour to code

Ice White glass
 *CGA

Gold
 *MOA

Chrome
 *MCA

Maple
 *LAC

Cherry
 *LCA

Mahogany
 *LWA

NEW

CHORUS COVER PLATES

ONE Plates Technopolymer

Milk White
GW16102TB 2 gang
GW16103TB 3 gang
GW16104TB 4 gang
GW16106TB 6 gang

Titanium
GW16102VT 2 gang
GW16103VT 3 gang
GW16104VT 4 gang
GW16106VT 6 gang

LUX Plates Technopolymer

Milk White
GW16202TB 2 gang
GW16203TB 3 gang
GW16204TB 4 gang
GW16206TB 6 gang

Toner Black
GW16202TN 2 gang
GW16203TN 3 gang
GW16204TN 4 gang
GW16206TN 6 gang

LUX Plates Painted Technopolymer

Titanium
GW16202VT 2 gang
GW16203VT 3 gang
GW16204VT 4 gang
GW16206VT 6 gang

Slate
GW16202VA 2 gang
GW16203VA 3 gang
GW16204VA 4 gang
GW16206VA 6 gang

LUX Plates Metallic Technopolymer

Chrome
GW16202MC 2 gang
GW16203MC 3 gang
GW16204MC 4 gang
GW16206MC 6 gang

Gold
GW16202MO 2 gang
GW16203MO 3 gang
GW16204MO 4 gang
GW16206MO 6 gang

LUX Plates Wood

Maple
GW16202LA 2 gang
GW16203LA 3 gang
GW16204LA 4 gang
GW16206LA 6 gang

Cherry
GW16202LC 2 gang
GW16203LC 3 gang
GW16204LC 4 gang
GW16206LC 6 gang

LUX Plates Metal

Brushed Stainless Steel
GW16202MI 2 gang
GW16203MI 3 gang
GW16204MI 4 gang
GW16206MI 6 gang

LUX Plates Glass

Ice
GW16202CG 2 gang
GW16203CG 3 gang
GW16204CG 4 gang
GW16206CG 6 gang

ART Plates Technopolymer

Milk White
GW16302TB 2 gang
GW16303TB 3 gang
GW16304TB 4 gang

Toner Black
GW16302TN 2 gang
GW16303TN 3 gang
GW16304TN 4 gang

ART Plates Wood

Maple
GW16302LA 2 gang
GW16303LA 3 gang
GW16304LA 4 gang

Cherry
GW16302LC 2 gang
GW16303LC 3 gang
GW16304LC 4 gang

ART Plates Stone

Moon
GW16302RN 2 gang
GW16303RN 3 gang
GW16304RN 4 gang

Sand
GW16302RS 2 gang
GW16303RS 3 gang
GW16304RS 4 gang

LUX Plates Metal

Titanium
GW16202XT 2 gang
GW16203XT 3 gang
GW16204XT 4 gang
GW16206XT 6 gang

Gunbarrel Grey
GW16202ML 2 gang
GW16203ML 3 gang
GW16204ML 4 gang
GW16206ML 6 gang

Technopolymer

Milk white
 Toner black
 Titanium

Wood

Maple
 Mahogany
 Cherry

Stone

Lava
 Sand
 Moon

Leather

Black
 White
 Ruby

Glass

Ice
 Aqua
 Ochre

Metal

Brushed stainless steel
 Titanium
 Gunbarrel Grey

For a further selection of Plates, Colours, Finishing's and combinations, please consult the Gewiss Chorus Catalogue

NEW

CHORUS INSULATION ACCESSORIES



Watertight Plates for 4 x 2 c/w support

Code	Description	Colour
GW16703TB	3 gang	White
GW16703TN	3 gang	Black



Watertight Plates for 3 x 3 c/w support

Code	Description	Colour
GW16702TB	2 gang	White
GW16702TN	2 gang	Black

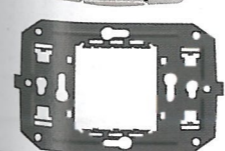

Supports

Code	Description
GW16802	2 gang
GW16803	3 gang
GW16804	4 gang
GW16806	6 gang



Wall-Mounting Instrument Panel

Support & plate not included. For use with ONE plates

Code	Description	Colour
GW16854	4 gang	White
GW16856	6 gang	White
GW16864	4 gang	Black
GW16866	6 gang	Black



(Empty)

Rectangular Boxes

Code	Description
GW24403	2/3 gang
GW24205	4 gang
GW24236	6 gang

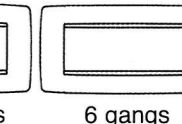
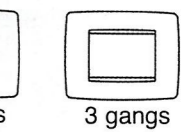
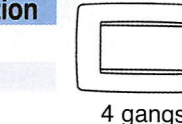
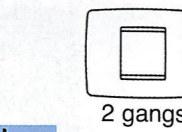

NEW

CHORUS LUX SWITCH RANGE

WHITE / WHITE SWITCHES

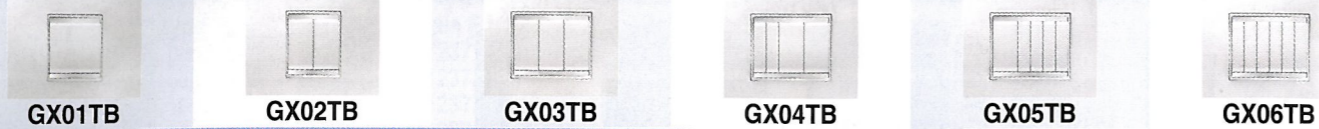

TONER BLACK / BLACK SWITCHES



TITANIUM / TITANIUM SWITCHES

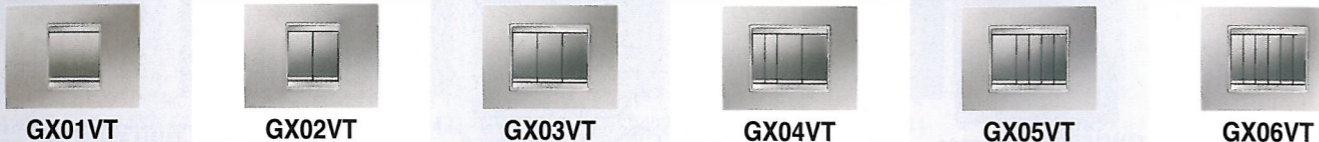

SLATE GREY / BLACK SWITCHES



Also available in:

*Add colour to code

Ice White glass
*CGA

Gold
*MOA

Chrome
*MCA

Maple
*LAC

Cherry
*LCA

Mahogany
*LWA

CHORUS LUX DATA RANGE

WHITE / WHITE SWITCHES & SOCKETS

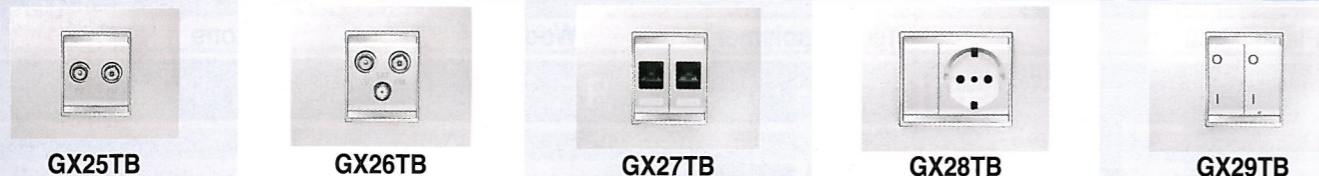

TONER BLACK / BLACK SWITCHES & SOCKETS



TITANIUM / TITANIUM SWITCHES & SOCKETS

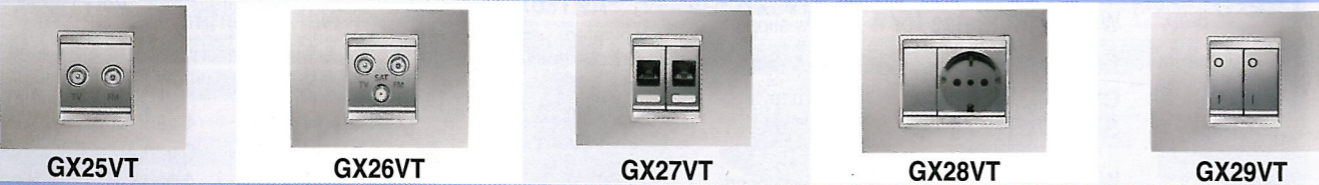

SLATE GREY / BLACK SWITCHES & SOCKETS



Also available in:

*Add colour to code

Ice White glass
*CGA

Gold
*MOA

Chrome
*MCA

Maple
*LAC

Cherry
*LCA

Mahogany
*LWA

NEW

CHORUS LUX SOCKET RANGE

WHITE / WHITE SOCKETS

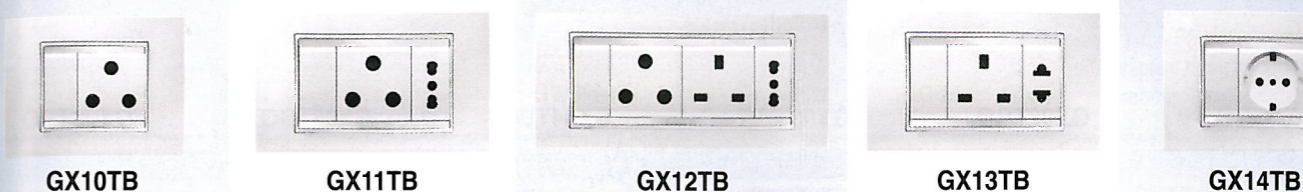

TONER BLACK / BLACK SOCKETS

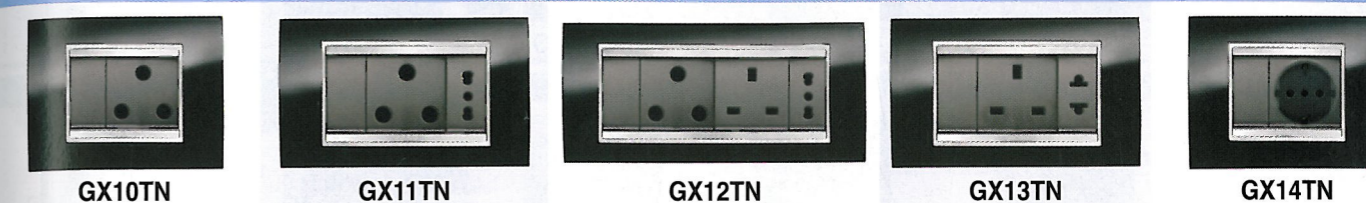

TITANIUM / TITANIUM SOCKETS

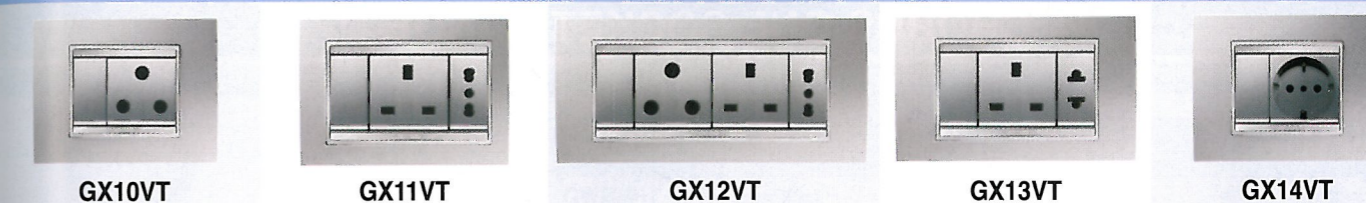

SLATE GREY / BLACK SOCKETS



ICE WHITE GLASS / WHITE SOCKETS

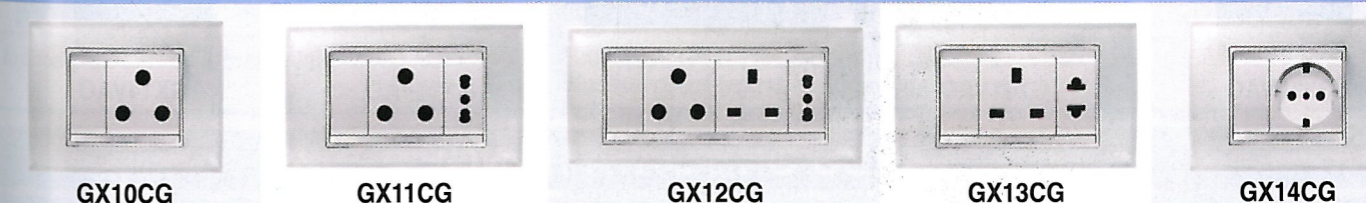

GOLD / WHITE SOCKETS



CHROME / WHITE SOCKETS

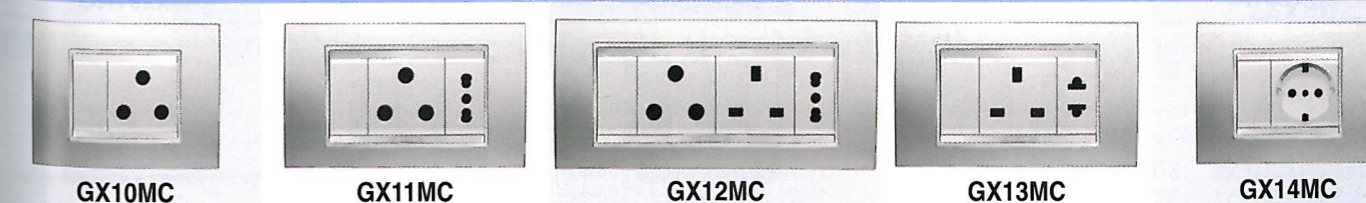

NEW

CHORUS ONE SWITCH RANGE

WHITE / WHITE SWITCHES

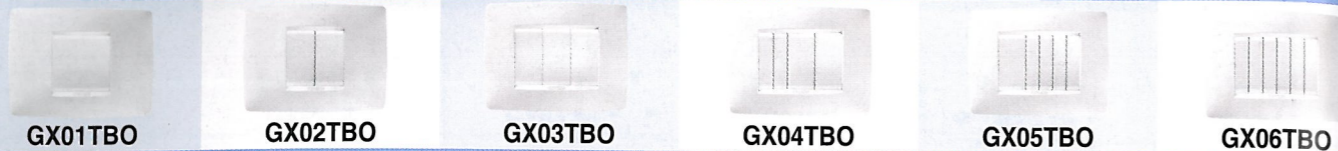

TONER BLACK / BLACK SWITCHES

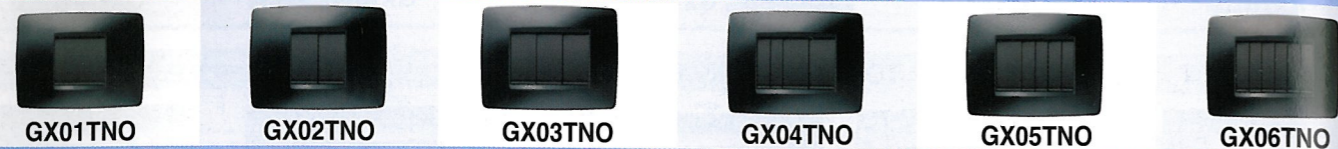

TITANIUM / TITANIUM SWITCHES

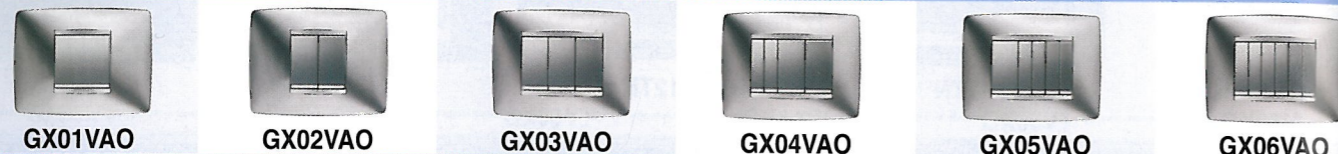

CHORUS ONE SOCKET RANGE

WHITE / WHITE SOCKETS

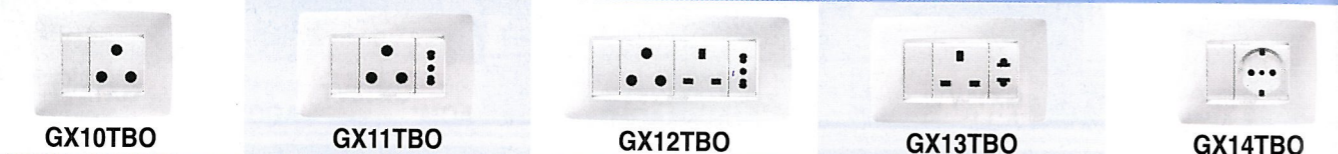

TONER BLACK / BLACK SOCKETS



SLATE GREY / BLACK SOCKETS



CHORUS ONE DATA RANGE

WHITE / WHITE SWITCHES & SOCKETS



TONER BLACK / BLACK SWITCHES & SOCKETS



SLATE GREY / BLACK SWITCHES & SOCKETS



Complies to Safety Standard IEC60598-2-5

OUTDOOR FEATURE LIGHTING

Garden Light E.S.L. Lamp **IP55** (Excluding Lamp) Voltage: 230V – 50Hz

Code	No. Lamps	Lamp Power	Lamp Type	Lamp Holder	Colour	Height (mm)
GW82006	1	11W	PL-11	G23	Graphite Grey	447
GW82007	1	26W	PLC-26	G24d-3	Graphite Grey	502



Variable Focus Restricted Beam Optics

Code	Lamp Power	Lamp Volts	Lamp	Current	Colour	Weight (kg)
For mains-connected Halogen lamps – IP66						
GW84374	100W	230V	B15d	0.43A	Graphite Grey	1.6
JD-100	100W	230V	Halogen Lamp B15d			

For extra low voltage Halogen lamps with built-in transformer IP66

Voltage: 230V – 50Hz						
GW84387	50W	12V	JCD		Graphite Grey	2.7
GW84389	75W	12V	JCD		Graphite Grey	2.8
GW84361	Anti-glare louvre – Aluminium				JC-12-50 12V Lamp	
GW84359	Elliptic Frensel lens				JC-12-75 12V Lamp	

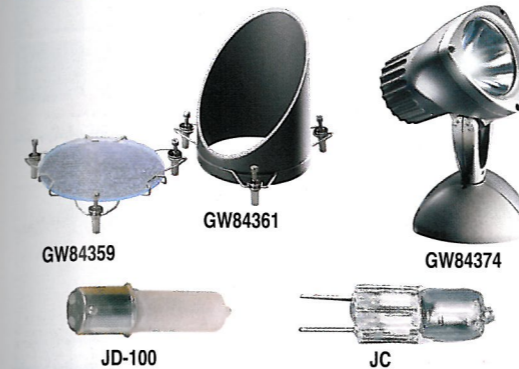

Spherical Globe complete with base and 60mm fibreglass pole height 1m IP54 Class II (Material: Polycarbonate)

Code	Finish	Dia. mm	Max Lamp Type	Lamp Holder	Weight (kg)
GW86851	Transparent	250	60W/Energy savers	E27	2
GW86852	Opal	250	60W/Energy savers	E27	2
GW86853	Smoked	250	60W/Energy savers	E27	2

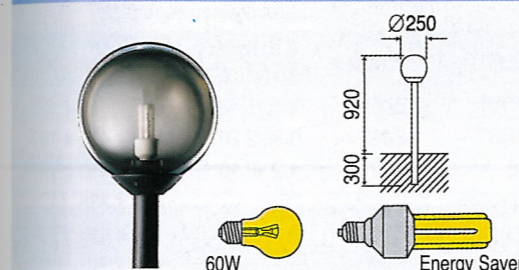

Spherical Globe complete with base and arm for surface installation IP54 Class II (Material: Polycarbonate)

Code	Finish	Dia. mm	Max Lamp Type	Lamp Holder	Weight (kg)
GW86861	Transparent	250	60W/Energy savers	E27	1.5
GW86862	Opal	250	60W/Energy savers	E27	1.5
GW86863	Smoked	250	60W/Energy savers	E27	1.5

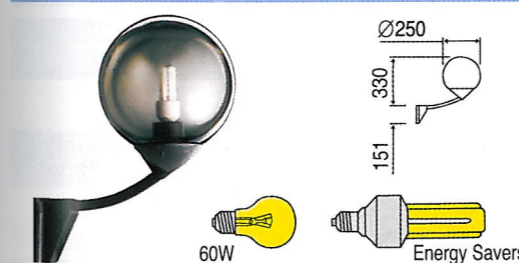

Authority Certificate No. 016989/001

80 Bolla Range - Round luminaires IP55 Weatherproof round bulkhead luminaires Polycarbonate base & diffuser. (Lamps to be ordered separately.)

Code	Max power	Base colour		
Waterproof round bulkhead luminaires - Dia: 200mm, H115mm				
Incandescent Lamps			Fluorescent Lamps	
GW80616	60W (E27)	Grey	GW80619	2 x 7W (G23)
GW80761	60W (E27)	Graphite Grey	GW80762	2 x 7W (G23)



Waterproof round bulkhead luminaires - Dia: 260mm, H140mm				
Incandescent Lamps			Fluorescent Lamps	
GW80622	100W (E27)	Grey	GW80625	2 x 9W (G23)
GW80763	100W (E27)	Graphite Grey	GW80764	2 x 9W (G23)

Authority Certificate No. 016986/001

80 Guscio Range - Weatherproof rectangular luminaires IP55 Incandescent and fluorescent lamps. Polycarbonate base and diffuser. 250 x 175 x 130mm (Lamps to be ordered separately)

Rectangular bulkhead luminaires - Incandescent Lamps				Fluorescent Lamps	
		1 x 9W		2 x 9W	
GW80601	60W (E27)	Grey	GW80604	GW80607	
GW80771	60W (E27)	Graphite Grey	GW80772	GW80773	



Weatherproof rectangular bulkhead luminaires - 320 x 225 x 165mm				
Incandescent lamps			Fluorescent lamps	
GW80610	100W (E27)	Grey	GW80613	26W (G24d-3)
GW80774	100W (E27)	Graphite Grey	GW80775	26W (G24d-3)

For photometric data, refer to data CD or visit www.gewiss.com

HIGHBAY LIGHT FITTINGS



Aluminium Type

Acrylic Type



GW83531/7



Halle TS Range High Bay 230V IP65 Control Gear. 470mm ø bowl

Acrylic Reflector	Power	Lamp	Holder	Weight	Current ST/Run	Aluminium Reflector
GX83881	250W	QE	E40	5.2kg	2.60/1.35	GX83781
GX83882	400W	QE	E40	6.4kg	4.20/2.10	GX83782
GX83403	250W	ME-SE	E40	6.4kg	2.10/1.42	GX83303
GX83406	400W	ME-SE	E40	7.8kg	3.80/2.20	GX83306

GW83531 IP65 Tempered glass bowl kit for Aluminium Reflector.

GW83537 IP65 PMMA bowl kit for Acrylic Reflector.

(Lamps excluded). QE (Mercury Vapour). ME-SE (Metal Halide & HPS)

KONO - High Bay. Weatherproof (240V) IP65

GW84805*	400W	ME-AT/SE-ST	E40	10.8kg	4.2A
----------	------	-------------	-----	--------	------

(Lamps excluded). *Add to code M (Metal Halide), S (High Pressure Sodium)

Fribay - Low Bay 230V, with power factor correction (Glass to be ordered separately)

Fitting	Power	Lamp	Holder	Current ST/Run	Dimensions
GX85943*	250W	MT/ST	E40	2.10/1.42	595 x 410 x 197
GX85945*	400W	MT/ST	E40	3.80/2.20	595 x 410 x 197
GX85931Q	400W	QE	E40	4.20/2.10	595 x 410 x 197
GW88259	Bottom Tempered Glass				342 x 335
GW84816	Flush-mounting frame				595 x 410 x 20

(Lamps excluded). *Add to code M (Metal Halide), S (High Pressure Sodium)

EMERGENCY LUMINAIRES WALL OR CEILING MOUNT

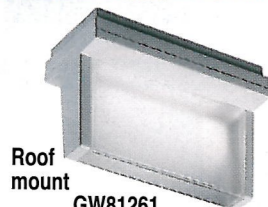

Roof mount
GW81261



GW81212/3/5/6
GW81257/9
GW81222/3/5/7



Wall mount
GW81266



Luminaire with safety sign fitted

Non-maintained NM lighting - IP40 Lamps included

Code	Power	Lamp Type	Duration	Batteries Type	Weight (kg)	Mounting Type
GW81212	8W	FD	over 1h	Ni-Cd	1.2	Wall
GW81213	8W	FD	over 3h	Ni-Cd	1.3	Wall
GW81257	24W	FD	over 1h	Ni-Cd	1.1	Wall

Maintained M lighting - IP40 Lamps included

GW81215	8W	FD	over 1h	Ni-Cd	1.2	Wall
GW81216	8W	FD	over 3h	Ni-Cd	1.3	Wall
GW81259	24W	FD	over 1h	Ni-Cd	1.1	Wall
GW81261	11W	FD	over 1h	Ni-Cd	1.3	Ceiling
GW81266	11W	FD	over 1h	Ni-Cd	1.5	Wall

Non-maintained IP65 Lamps included

GW81222	8W	FD	over 1h	Ni-Cd	1.1	Wall
GW81223	8W	FD	over 3h	Ni-Cd	1.2	Wall

Maintained IP65 Lamps included

GW81225	8W	FD	over 1h	Ni-Cd	1.2	Wall
GW81227	24W	FD	over 1h	Ni-Cd	1.7	Wall

Safety Signs - Self adhesive labels for above emergency luminaires



For IP40 GW80261
For IP65 GW80216



GW80262
GW80217



GW80263
GW80219



GW80264
GW80222

INDUSTRIAL LIGHT FITTINGS

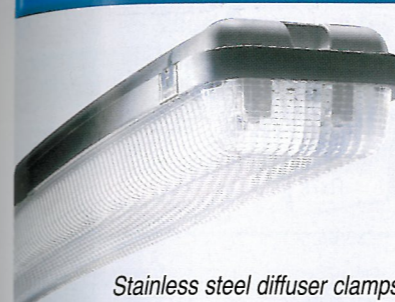

Stainless steel diffuser clamps

IP65 - ZNT Range - with P.F. correction RAL 7035 Grey shock resistant polycarbonate base, weatherproof light fitting

Twin Tube				Single Tube	
Code	Spare Diffuser	Lamp Power	Dimensions	Code	Spare Diffuser
GW80004	GW80134	18W	(2ft) 680 x 195 x 112	GW80001	GW80131
GW80005	GW80135	36W	(4ft) 1290 x 195 x 112	GW80002	GW80132
GW80006	GW80136	58W	(5ft) 1590 x 195 x 112	GW80003	GW80133

(Lamps excluded) Spares/Steelclips GW88255

INDOOR LIGHT FITTINGS



Iride Range - IP40

Polymer diffuser 'comfort' with differentiated glareproof prisms

Twin Tube	Size	Watts	Single Tube	Size
GW80553	(2ft) 625 x 180 x 60	18W	GW80551	(2ft) 625 x 110 x 75
GW80554	(4ft) 1250 x 180 x 60	36W	GW80552	(4ft) 1250 x 110 x 75
GW80555	(5ft) 1555 x 200 x 60	58W		

(Lamps excluded)

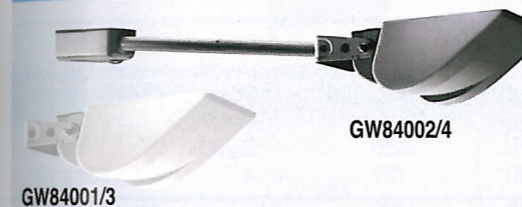

GW84002/4

GW84001/3

DOMUS - Wall light fitting for display IP23

Code	Power	Lamp	Holder	Colour
GW84001	200-300W	HD	R7s	White
GW84002	200-300W	HD	R7s	Graphite
GW84003	200-300W	HD	R7s	White
GW84004	200-300W	HD	R7s	Graphite

SIGNAL LAMPS & BULKHEAD LIGHT FITTINGS



80 Retta Range - Rectangular luminaires IP44

Incandescent lamps - 75W max (Lamps to be ordered separately)

Code	Lamp holder E27	Type	Code	Lamp holder B22	Carton Qty
GW80401		Transparent	-		12
GW80402		Yellow	-		12
GW80403		Red	GW80407*		12
GW80404		Green	GW80408*		12

*B22 only available while stocks last

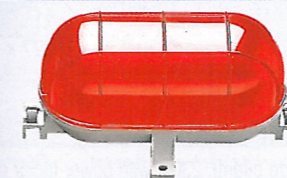

80 Tarta Range - Oval luminaires IP44

Incandescent lamps - 60W max (Lamps to be ordered separately)

GW80409	Transparent	-	36
GW80410	Yellow	GW80414*	36
GW80411	Red	GW80415*	36
GW80412	Green	GW80416*	36

*B22 only available while stocks last



26 External Range - Indicator lights - max 15W - IP55

(Lamps to be ordered separately)

Code	Diffuser colour	Lamp holder type	Dimensions H x W x D	Carton Qty	With 220V Flasher
GW27415	Red	E14	82 x 66 x 95	5/40	GW27415/F
GW27416	Green	E14	82 x 66 x 95	5/40	GW27416/F
GW27417	Yellow	E14	82 x 66 x 95	5/40	GW27417/F
GW27418	Transparent	E14	82 x 66 x 95	5/40	GW27418/F
GW27419	Blue	E14	82 x 66 x 95	5/40	GW27419/F

For Lamps ACL1 See page 509.

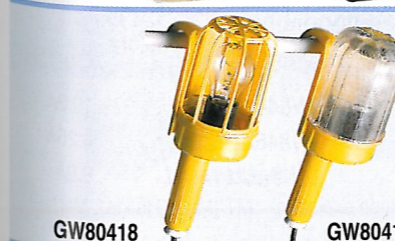

GW80418

GW80417

80 Hobby Range - Hand lamp

Hand lamp with unbreakable diffuser complete with switch, cable (6m) and plug (Lamp to be ordered separately)

GW80417	Max lamp power 40W	E27	16
---------	--------------------	-----	----

Hand lamp complete with protective guard, cable (4m) and plug

GW80418	Max lamp power 40W	E27	16
---------	--------------------	-----	----

FLOODLIGHTS

Floodlights for Discharge Lamps 230V IP55

Code	Power	Lamp	Holder	Code
Asymmetrical				Symmetrical

Urano - Die cast Aluminium Housing

GW84206*	70W	MD/ST	Rx7s	-
GW84207*	150W	MD/ST	Rx7s	-

Spare lamps: ST-70, ST-150, MD-70 & MD-150

Horus - High Temp Plastic Housing IP65

GX85301*	70W	MD/ST	Rx7s	GX85001*
-	150W	MTE/SD	E27	GX85002*

(Complete with lamp). *Add to code M (Metal Halide), S (High Pressure Sodium)

Spare lamps: ST-70, SD-150-E27, MD-70 & MTE-150

Horus Symmetrical Floodlights with E.S. Lamps 230V IP65

Code	No. Lamps	Lamp Power	Lamp Type	Lamp Holder	Current	Weight (kg)
GX85306	2	18W	PLC-18	G24d-2	0.375A	2.7
GX85307	2	26W	PLC-26	G24d-3	0.4A	2.7
GX85066	2	42W	PLCE-42	G24q-4	0.45A	5.2

(Excluding Lamps) For lamps see page 501.

Genius - Floodlights for halogen lamps IP55

Code	Power	Lamp	Holder	Amps	Dimensions
GW84201	500W	HD	R7s	2.2A	180 x 155 x 120
GW84202	1000W	HD	R7s	4.5A	355 x 230 x 150
GW84203	1500W	HD	R7s	6.5A	355 x 230 x 150

(Lamps excluded) HD (Linear Halogen) For lamps see page 510.

Genius - Floodlights on yellow tubular stand IP55

GW84204	500W	HD	R7s	2.2A	245 x 345 x 245
GW84205	1000W	HD	R7s	4.5A	420 x 470 x 355

(Lamps excluded). HD (Linear Halogen). For lamps see page 510.
c/w protective wire guard, 5m (1.5 x 3 core) cable fitted with a 16A 2P+E (IP67) 250V plug

Urano-Pro symmetrical floodlights with P.F. correction IP66

GX84261*	70W	MD/ST	Rx7s	0.75/0.50	277 x 343 x 235
GX84263*	150W	MD/ST	Rx7s	1.30/0.88	277 x 343 x 235

(Complete with lamp). *Add to code M (Metal Halide), S (High Pressure Sodium)

Spare lamps: ST-70, ST-150, MD-70 & MD-150

Titano - Diffused optics floodlights IP66 (wide beam). 230V, with power factor correction

Symmetrical	Power	Lamp	Holder	Dimensions	Asymmetrical
GX84465	250W	MT/SD	E40	418 x 328 x 260	GX84491
GX84466	400W	MT/SD	E40	418 x 328 x 260	GX84494

Titano - restricted floodlights IP66 (narrow beam)

GX84520	250W	MT/SD	E40	418 x 328 x 260	GX84552
GX84522	400W	MT/SD	E40	418 x 328 x 260	GX84554

(Lamps excluded). Suitable for MT (Metal Halide) or ST (High Pressure Sodium) lamps. Code for lamps MT-250, MT-400 (MH), SD-250, SD-400 (HPS)

Colosseum/Stadium - Symmetrical diffused floodlights IP66

Code	Power	Lamp	Holder	Control Gear	Current
GW84647	1000W	MT/SD	E40	GW84616 230V	10.3A
GW84648	1000W	MT	E40	GW84627 230V	8.25A
GW84663	2000W	MT	E40	*GW84621 400V	9.8A

NOTE: Fitting and control gear are separate items. (Lamps excluded). MT (Metal Halide), MN (Metal Halide). ST (High Pressure Sodium) *400V supply only 1PH (L-L).

Urano



GW84206/7

Horus



GX85001/2



GX85306



GX85066



Fitting



Control Gear

FLOODLIGHTS WITHOUT CONTROL GEAR



Wide Beam IP66 Die-Cast Aluminium

Lamps excluded

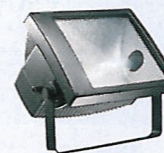

Symmetrical



Asymmetrical

Code	GW84433	GW84434	GW84435	GW84436
Lamp	E40	E40	E40	E40
Watts	250/400	250/400	250/400	250/400
Size	418 x 328 x 260	418 x 328 x 260	418 x 328 x 260	418 x 328 x 260

Lamps excluded

High Temperature Plastic Housing IP55



Symmetrical



Asymmetrical

Code	GW85091	GW85092	GW85391	GW84291	GW85931
Lamp	Rx7s	E27	Rx7s	Rx7s	E40
Watts	70/150		70/150	70/150	250/400
Size	315 x 250 x 125		315 x 250 x 125	277 x 343 x 235	595 x 410 x 197

Lamps excluded

High Temperature Plastic Housing IP65



Symmetrical



Asymmetrical

Code	GW85392	GW85097	GW83518	GW83510
Lamp	PL	PLCE	E40	E40
Watts	2 x 13/18/26	2 x 42	250/400	250/400
Size	390 x 335 x 140	390 x 335 x 140	470Ø	470Ø

High Bay IP65



Acrylic



Aluminium

MULTI PURPOSE LIGHTS IP55



GW82290



GW82298



GW82292

Extro Range Multi Purpose Luminaire IP55 230V

Code	Power	Lamp	Holder	Colour
GW82284	2x18w	NB5025 18W	2G11	Graphite Grey
GW82286	2x26-32W	PLC-26	GX24q3	Graphite Grey

(Lamps excluded). Polycarbonate housing, stainless steel screws

Extro Range Accessories

Code	Description	Material	Pack
GW82290	Wall mounting swivel bracket	Die cast AL	1/6
GW82298	Single fitting pole mounting bracket 60mm Ø	Die cast AL	1/5
GW82292	Single fitting Aluminium column 1.3m height	Die cast AL	1/1
GW88272	Spare tempered & sandblasted glass 280 x 250	Glass	1/5



CABLE RACKING - PERFORATED STEEL

Perforated Galvanized Steel Tray

Protection: Continuous hot-dip galvanizing of sheet metal before manufacturing. Z275 zinc finish is 21 microns. Ideal for indoor installations in a normal environment

Description		Side Wall 35mm High					
		65mm W	95mm W	155mm W	215mm W	305mm W	395mm W
Cable Tray, 3m length	Carton (Qty)	MV40100 (30)	MV40101 (30)	MV40103 (18)	MV40105 (12)	MV40108 (6)	MV40111 (6)
90° Horizontal Bend (External Bend)	Carton (Qty)	MV42100 (2)	MV42101 (2)	MV42103 (2)	MV42105 (2)	MV42108 (2)	MV42111 (2)
45° Horizontal Bend	Carton (Qty)	MV43100 (2)	MV43101 (2)	MV43103 (2)	MV43105 (2)	MV43108 (2)	MV43111 (2)
Horizontal T junction	Carton (Qty)	MV46100 (2)	MV46101 (2)	MV46103 (2)	MV46105 (2)	MV46108 (2)	MV46111 (2)
Horizontal cross junction (4 Way)	Carton (Qty)	MV47100 (2)	MV47101 (2)	MV47103 (2)	MV47105 (2)	MV47108 (2)	MV47111 (2)
T Branch	Carton (Qty)	MV49100 (2)	MV49101 (2)	MV49103 (2)	MV49105 (2)	MV49108 (2)	MV49111 (2)
Upward Curve (Riser)	Carton (Qty)	MV44100 (2)	MV44101 (2)	MV44103 (2)	MV44105 (2)	MV44108 (2)	MV44111 (2)
Downward Curve (Dropper)	Carton (Qty)	MV45100 (2)	MV45101 (2)	MV45103 (2)	MV45105 (2)	MV45108 (2)	MV45111 (2)

Accessories

	Pack Order Qty	Code	Ctn
Boltless speed lock coupler	1	MV41110	100
Straight jointing piece	1	MV41120	100
Pliable jointing piece	1	MV41130	200
Bolt & Nut M6 x10	/100	MV66100	100

Horizontal Junctions

Order Internal & External folding angles plus precut 45° bottom piece. Use two for 90°. Order Bolts separately

Folding Angle 90°/45° Internal	1	MV48100	10
Folding Angle 90°/45° External	1	MV48101	10
Pre-cut 45° Bottom Piece: Width	65/95mm	MV48131	10
	155/215mm	MV48132	10
	305mm	MV48133	10
	395mm	MV48134	10

Vertical Couplings

Order 2 x folding angles plus perforated bottom piece. Order Bolts separately

Folding Angle	1	MV48110	10
Bottom Piece (perforated)	1	MV48130	10



CABLE RACKING - WIRE MESH

Manufactured with all ends cleanly finished and bent over. No sharp edges! Fast installation.

Description	Width	BFR 30 - 30mm Height			BFR 60 - 60mm Height	
		100mm Code	150mm Ctn	200mm Code	300mm Ctn	500mm Code

Hot Dip Galvanized before manufacture to 20 microns. Excellent for indoor and outdoor installations in normal environment.

Cable Tray 3m length	MV50521	30	MV50522	18	MV50523	12	MV50535	6	MV50537
----------------------	---------	----	---------	----	---------	----	---------	---	---------

90° Horizontal Bend	MV52521	1	MV52522	1	MV52523	1	MV52535	1	MV52537
---------------------	---------	---	---------	---	---------	---	---------	---	---------

45° Horizontal Bend	MV53521	1	MV53522	1	MV53523	1	MV53535	1	MV53537
---------------------	---------	---	---------	---	---------	---	---------	---	---------

Small type: Vertical bends and coupling between different size achieved on site by cutting out sections, bending and clamping together

Accessories

Universal Support	MV51130	100	MV51131	70	MV51132	50	MV51133	40	MV51135
-------------------	---------	-----	---------	----	---------	----	---------	----	---------

Stainless Steel 304 for all aggressive environments including marine and chemical

Cable Tray 3m length	MV50621	30	MV50622	30	MV50623	18	MV50635	6	MV50637
----------------------	---------	----	---------	----	---------	----	---------	---	---------

90° Horizontal Bend	MV52621	1	MV52622	1	MV52623	1	MV52635	1	MV52637
---------------------	---------	---	---------	---	---------	---	---------	---	---------

45° Horizontal Bend	MV53621	1	MV53622	1	MV53623	1	MV53635	1	MV53637
---------------------	---------	---	---------	---	---------	---	---------	---	---------

Vertical bends and coupling between different size achieved on site by cutting out sections, bending and clamping together

Accessories

Universal support attaches to bottom of tray	MV51630	100	MV51631	70	MV51632	50	MV51633	40	MV51635
--	---------	-----	---------	----	---------	----	---------	----	---------

Support S/S 304	MV64670	30	MV64671	30	MV64671	30	MV64672	30	MV64674
-----------------	---------	----	---------	----	---------	----	---------	----	---------

Accessories for all sizes

	Pack Order Qty	Galvanized Code	304 Stainless Code
Straight coupler - rigid coupling	1	MV51123	MV51623
Nut, bolt and clamp for straight coupler above	/100	MV51422	-
Universal Coupler: Outside clamp	/100	MV51420	MV51620
	/100	MV51421	MV51621
M6 x 20 bolt & nut	/100	MV66403	MV66620
Junction box support	1	MV51101	MV51601
Suspension Hanger (use 8mm ø threaded bar)	1	MV51105	MV51605
Safety nylon rivet for above	100	MV51806	MV51806
Boltless speed lock coupler	1	MV51110	-
8mm ø Threaded bar	/m	THREAD M8	-
Shears with asymmetrical blades (Bolt cutter)	1	HT10-6214	-

CABLE RACKING - SUPPORT SYSTEMS - HOT DIP-GALVANISED

Medium Loads - Cantilever Bracket

Length	Load	Code	Ctn
150mm	85kg	MV60230	100
200mm	85kg	MV60231	80
250mm	85kg	MV60232	50
350mm	100kg	MV60233	25
450mm	90kg	MV60234	20

Order Cantilever bracket with adjustable support and pin

Adjustable support for Cantilever Bracket

Description	Pack	Code	Ctn
Adjustable support	1	MV64213	25
Split Pin 6 x 70mm	100	MV64114	100

Double Duty Bracket

Length	Load	Code	Ctn
150mm	60kg	MV60241	80
250mm	130kg	MV60243	40

Heavy Loads - Mavistrut System

Mavistrut	Profile	Max Bracket	Code	Ctn
Twin notched profile c/w welded ceiling bracket	630mmL 41x29	345mm	MV63207	14
	1030mmL 41 x 41	445mm	MV63215	6
Ceiling fixing plate supplied with bolts as illustrated	41 x 29	345mm	MV64230	25
	41 x 41	445mm	MV64240	15
Mavistrut notched profile 3030mm long	41 x 29	345mm	MV65273	8
	41 x 41	445mm	MV65276	8

Mavistrut Brackets

Brackets for Mavistrut notched profile. Clip on cantilever bracket

Length	Max Load	Code	Ctn
145mm	110kg	MV61200	50
245mm	100kg	MV61201	36
345mm	100kg	MV61202	25
445mm	171kg	MV61203	16

Support Brackets Can mount onto wall or onto Mavistrut by using spring nut and hex screw below

Profile	Length	Max Load	Code	Ctn
41 x 29	150mm	270kg	MV61231	20
	200mm	200kg	MV61232	20
41 x 41	300mm	350kg	MV61243	15
	400mm	300kg	MV61244	15
	500mm	270kg	MV61245	12

Accessories

Description	Mavistrut	Dimension	Pack	Code	Ctn
Spring Nut	41 x 29	M8	100	MV66152	100
Hex Head Screw	41 x 41	M8	100	MV66157	100
		M8 x 25	100	MV66133	100

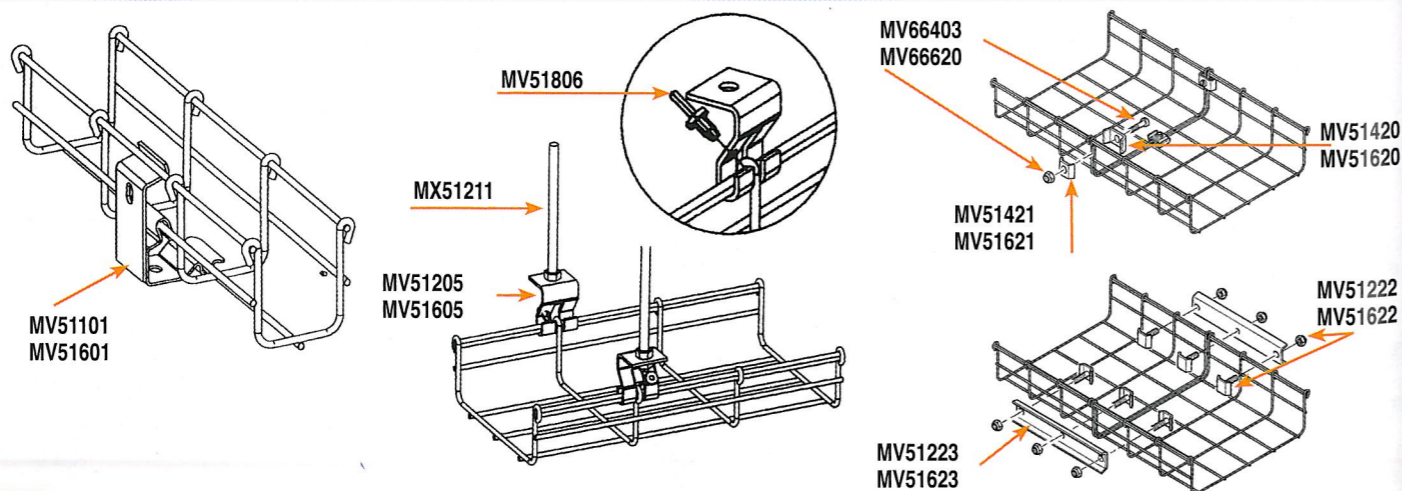

POWER SKIRTING - SLK & EK RANGES

Compact Power Skirting for individual rooms & offices - SLK Range

A complete, integrated system to make stylish surface installations that match the various rooms décor perfectly. Available in RAL9010 white and in RAL7021 Anthracite (black)

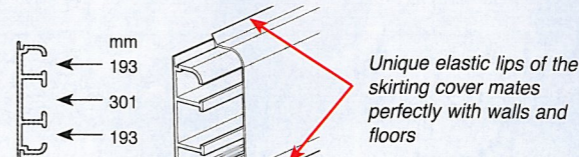

Size: 70 x 20 (3 Compartment) Trunking 2m lengths

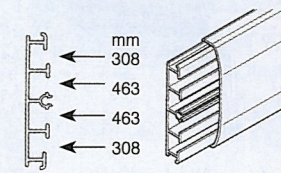

Size: 120 x 25 (4 Compartment) 2m lengths For Horizontal or Vertical

Order covers separately
• Supplied in 2 metre lengths

Type	Trunking	Horizontal Cover	Vertical Cover	Trunking	Cover
Code	Grey NP42003	White NP42018 Black NP42020	White NP42402 Black NP42404	Grey NP42004	White NP42024 Black NP42026
Code					
Carton Qty	50	50	50	24	24

Routing Components

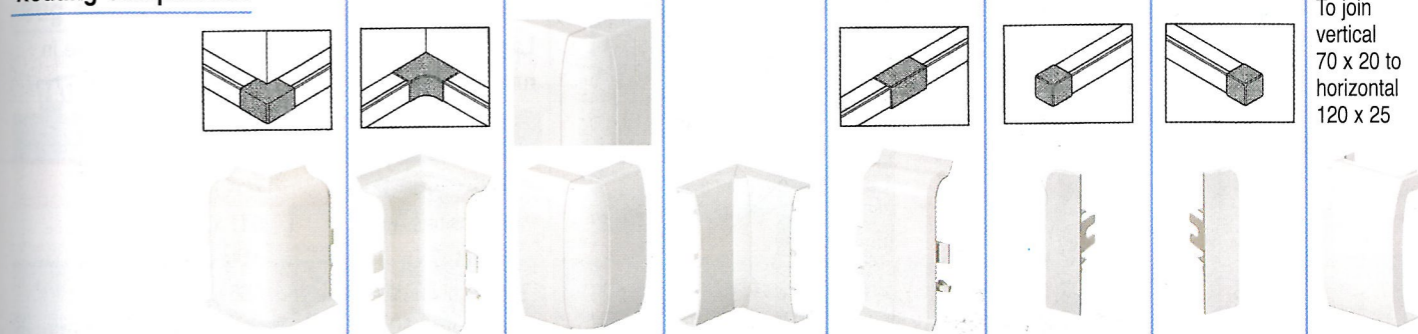

Type	Ext. Corner	Int. Corner	Ext. Adj. Corner	Int. Adj. Corner	Coupling	End Cover Right	End Cover Left	Connector
Code	White NP42054 Black NP42056	White NP42072 Black NP42074	-	-	White NP42120 Black NP42122	White NP42162 Black NP42164	White NP42138 Black NP42140	White NP42276 Black NP42278
Code	White - Black -	White - Black -	White NP42060 Black NP42062	White NP42078 Black NP42080	White NP42126 Black NP42128	White NP42180 Black NP42182	White NP42180 Black NP42182	White NP42276 Black NP42278
Carton Qty	10	10	5	5	10	10	10	5

Device Boxes See System Range for socket outlet, data and telecom outlets

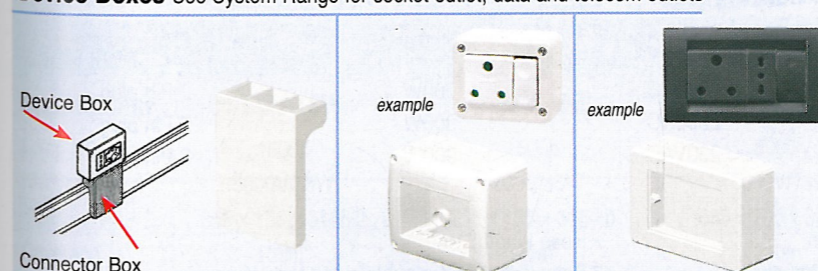

Type	Connector to device box	Requires modules only	Requiring mounting plate, modules and cover plate to enable colour co-ordination
Code	White NP42462 Black NP42464	3 Gang White GW27615 4 Gang White GW27621	3 Gang White NP40432 4 Gang White NP40438
Code	White NP42456 Black NP42458	Black GW27616 Black GW27622	Black NP40434 Black NP40440
Carton Qty	10	10	10

Corner Trunking - EK Range

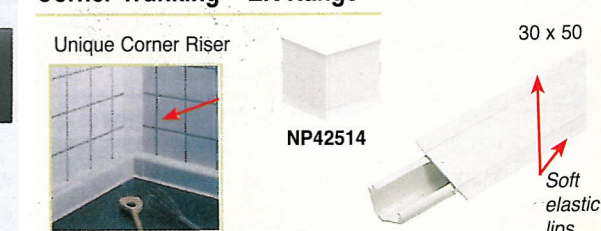

Description	Code	Ctn Qty
Corner trunking c/w cover 2m length	NP42502	34
Connector to join to 70 x 20 skirting	NP42264	10
Tee junction	NP42520	5
Internal corner	NP42514	5
External corner	NP42508	5
End cover	NP42526	10

For switches, sockets and other modular devices, see 20 system, white or black, see pages 384-387.

INSECT KILLERS

BUGTRAPS (using sticky pads) HACCP compliant



Code	M-397	M-700	M-701	M-399	M-398
Spare Lamp	2 x UV-40WS shatter proof	2 x UV-PL15	2 x UV-PL15	1 x UV-E27 20W	1 x UV-E27 20W
Dimensions in mm	655 x 390 x 235 (H)	112 x 435 x 400 (H)	400 x 1475 x 135 (H)	400 x 170 x 350 (H)	400 x 170 x 270 (H)
Weight	8,8kg	2,5kg	2,2kg	1,4kg	2,9kg
Total consumption	95W	40W	40W	20W	20W
Lamp life	2000 hours	2000 hours	2000 hours	2000 hours	2000 hours
Production material	Steel (painted)	Aluminium/Plexiglass	Aluminium/Plexiglass	Polystyrene	S/Steel
Std. Accessories	Chain/Adhesive paper	Chain/Adhesive paper	Chain/Adhesive paper	Chain/Adhesive paper	Chain/Adhesive paper
Dimension of paper	-	34,5 x 17cm	34,5 x 17cm	-	-
IP grade	IP65	IP65	IP65	<input type="checkbox"/> Double insulated	<input type="checkbox"/> Double insulated
Covering	850m ²	up to 320m ²	up to 100m ²	50m ²	50m ²
Adhesive spare Pad	M-1625	M-2413	M-2413	M-2413	M-2413



The Turbine is of particular value in rural areas and on farms. Eliminates the need for pesticides and insecticides that could damage crops or health of animals. Insects are attracted by UV lamps and sucked into a 25 litre bag by a fan.

Turbine

Large volume HACCP compliant bug trap for use in rural areas and on farms

Code	M-30602
Spare Lamp	2 x UV-40W
Dimensions (mm)	941 x 407 x 356
Weight	11kg
Total consumption	165W
Lamp life	2000 hours
Range of operation	15-18m
Material	Stainless Steel/Aluminium
Standard Accessories	Net collection bag
IP Range	IPx4

HYGIENE PRODUCTS

Wall Mounted Hair Dryers

Code	Voltage	Power	Connection
M320	230VAC	700W	2 Pin plug
M329	230VAC	900W	2 Pin plug
M359	230VAC	900W	2 Pin plug

Features

- Double insulation
- On/Off by lifting handle
- Hose length: 1m
- Easy installation: double sided tape or screws

Wall Mounted Hand Dryers

Code	Voltage	Power	Outside casing material	Connection
M315	230VAC	2125W	Plastic	Cable
M332	230VAC	2125W	316 Stainless Steel	Cable

Features

- Double insulation
- Sensor activated

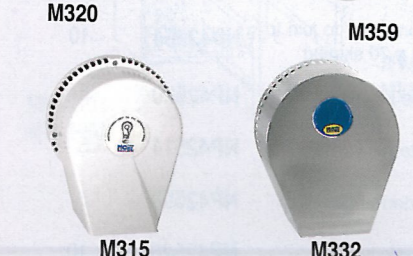

Complies to Safety Standard IEC 60335-2-99

INSECT KILLERS AND TRAPS

Bugtraps

Type	Basic	Sterilizer	Economy - 1 speed fan	Economy - 1 speed fan	12VDC & 230VAC
Code	M-361	M-363	M-368	M-396	M-334
Spare Lamp	UV-A	UV-A	UV-A	UV-15W	UV-PL7
Power	55W	75W	55W	35W	16W
Fan Speed	900/1050rpm	900/1050rpm	900rpm	950rpm	1000rpm
Coverage	180m ²	180m ²	180m ²	100m ²	35m ²
Application	Home, Office and General shop use. Low speed for silent running to catch mosquitoes at night.	As M-361 but with internal UV-C Lamp to sterilise insects caught in drawer. For restaurants, food shops and hospitals.	Single speed economy for catching mosquitoes, flies and other insects day and night. For home and office use.	Economy Bug Trap - Home and Office use. Coverage 100m ²	Bug Trap c/w battery, AC Adaptor and 12VDC car lighter plug. Operating on 230VAC mains, 12VDC or on Internal Battery for 3 hours.

- Traps mosquitoes, flies and other insects
- No noise
- No harmful emissions
- Bugs trapped in drawer which seals when fan is off
- Desk top or shelf mounting

Size: 245 x 215 x 340(H)
Housing: ABS
HACCP compliant

Bug Killers (Domestic)

Code 230V	M-300	M-369	M-7124
Spare Lamp Code	1 x UV-6W	2 x UV-15W	Lamp: M-7111 Paper: M-2768
Lamp Life	1500h	2000h	4000h
Net Voltage/Power	1500VDC/11W	5000VDC/45W	24W
Size	132 x 165 x 330(H)	385 x 105 x 290(H)	290 x 170 x 420(H)
Coverage	65m ²	320m ²	200m ²

Bug Killers (Professional)

Code 230V	M-304	M-309	M-305E	M-307E	M-308E
Spare Lamp	1 x UV-15W	2 x UV-15W	1 x UV-20W	2 x UV-20W	2 x UV-40W
Lamp Life	1500h	1500h	3000h	3000h	2000h
Net Volt/Power	5000V/35W	5000V/45W	5000V/45W	5000V/65W	5000V/95W
Size	355 x 155 x 315(H)	355 x 155 x 315(H)	685 x 200 x 380(H)	685 x 200 x 380(H)	685 x 200 x 380(H)
Coverage	160m ²	320m ²	210m ²	430m ²	850m ²

GAMA-SONIC®

Code 230V	GS-010
Spare Lamp Code	2 x UV-10W
Lamp Life	1000h
Net Voltage	5000VDC
Size	380 x 120 x 275(H)
Coverage	170m ²



Insect Extraction Fan

Code	M-354
Lamp Code	UV-A 1 x 32W
Lamp Life	2000h
Total Consumption	45W
Air Speed	3.1m/s glass installation
Air Flow	270m ² glass installation
Wall Pipe Dia.	150mm
Glass Hole Dia.	187mm
IP Grade	IP44



INFRARED HEATERS

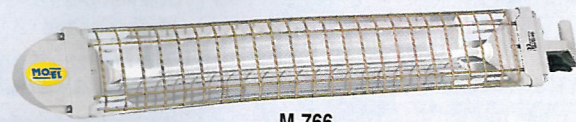

M-766
M-767

FIORE IP65

Fiore Modular system was designed to provide a wide range of combinations to meet different requirements.

Code	Watts	Size	Coverage
M-766	1200W	712 x 112 x 83(h)	4-6Sq.m
M-767	1800W	835 x 112 x 83(h)	8-10Sq.m

Complete with 3m cable & on / off switch

Accessories

Code	Description
M-768P	Bracket for post or tri-pod fixing
M-768S	2 x 1.8m Chain for ceiling fixing
M-768M	Bracket for wall mounting
M-2473	Tri-Pod c/w safety latch 1900mm (max)
M-2450	Spare 1200W heater lamp for M769P, M-769S, M-766
M-2781	Spare 1800W heater lamp for M-767

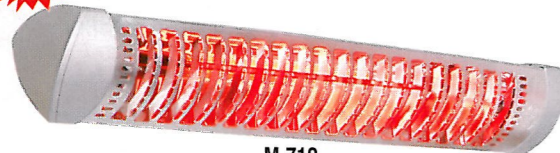
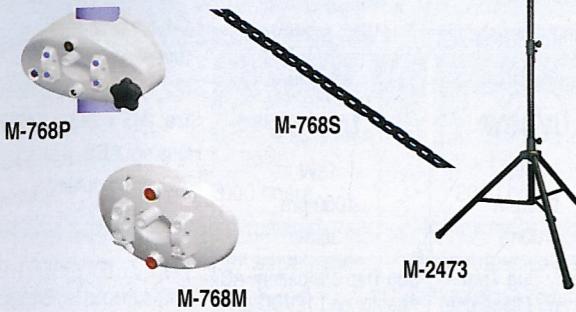

M-712
M-718

M-702

SHARKLITE IP55

Sharklite was designed to meet the requirement of sturdiness without compromising design.

Code	Watts	Size	Coverage
M-712	1200W	792 x 150 x 100(h)	4-6Sq.m
M-718	1800W	912 x 150 x 100(h)	8-10Sq.m

Complete with 3m cable & on / off switch

Accessories

Code	Description
M-3018	Spare 1200W heater lamp for M-712
M-3024	Spare 1800W heater lamp for M-718
M-702	Tri-Pod for Sharklite M-712 & M718 heaters

Ruby coloured lamps are easy on the eyes.

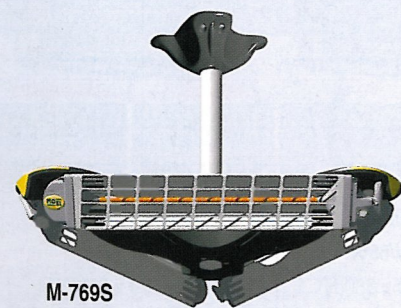

M-769S

M-769P

GIRESOLE IP65

Complete with 3m cable and independant switch for each heater.

Code	Watts	Description	Coverage
M-769P	3 x 1200W	Floor type c/w 2.35m pole & base	12-18Sq.m
M-769S	3 x 1200W	Ceiling mount with 0.4m (h) pole	12-18Sq.m



Effective... Infrared technology, using quartz halogen emitters with a tungsten filament, provides instant comfort. Heating efficiency is 92%, one Infrared installation of 3.6 kilowatts has the same efficiency rating as two gas heaters of 11 kilowatts. Suitable for outdoor use - in the rain! Lamp Life ± 5000hrs.

Accessories

Code	Description
M-2450	Spare 1200W heater lamp for M-769P, M-769S, M-766

WALL MOUNTING HEATERS

Wall Mounting Halogen Heaters

Code	Description
RH03A-P	2 Heat settings 600/ 1200W (2 Bar)
RH03B-P	3 Heat settings 500/ 1000/ 1500W (3 Bar)

- Heater's angle is adjustable (up/ down)
- Heater's angle is adjustable (up/ down)
- Heater's angle is adjustable (up/ down)
- c/w 1.6m cable
- Pull-chain control
- Size: 570 x 165 x 130mm

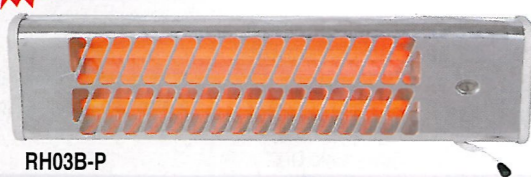

RH03B-P

HEATERS

Oscillating Heaters

Code	Watts	Description
NSB-120S	1200W	Halogen Heater - manual control (3 x Heat Settings)
NSB-120SY	1200W	Halogen Heater - c/w remote control (3 x Heat Settings)
N17-T	500/1000W	Far-Infrared Carbon Fibre Heater - manual control (2 Heat Settings)

Features include:

- Wide range of oscillation
- Rapid heating
- Can be used to cover area of 15-18m²



NSB-120S



N17-T

NSB-120SY



HFTV-1



NSB-200-J



NSB-200-L

Fan Heaters

Code	Watts	Size	Description
HFTV-1	750/1500W	225 x 140 x 265	Fan Heater with thermo cut-off • 2 Heat settings
NSB-200-L	2000W	220 X 120 X 210	Fan Heater with thermo cut-off • 3 Heat settings
NSB-200-J	1500W	200 x 160 x 300	Fan Heater with thermo cut-off • 3 Heat settings • With oscillating function

Halogen Heater

HH-5	800/1600W	540 x 200 x 435	• 2/ 3 Heat settings
NSB-120E	400/800/1200W	540 x 135 x 260	• Electricity & Energy saving infrared heating • Rapid heating speed • 15-18m ² coverage



NSB-120E



HH-5



X-OD-06-TR

Oil Filled Radiator Heaters

Code	Watts	Size	Description
X-OD-06F/7	7 Fin	390 x 170 x 665	• 3 Heat settings
X-OD-06F/9	9 Fin	470 x 170 x 665	• Adjustable thermostat
X-OD-06F/11	11 Fin	550 x 170 x 665	• Over heating protection

Accessories

Code	Description
X-OD-06-TR	Towel rail to fit onto all of the above heaters

Bathroom Lighting and Heating Lamps



LSA0807

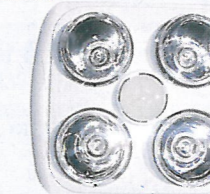

LSA0809



LSA309

Code	Panel Size (mm) L x W x D	Heat Lamp Wattage	Total Power	Extraction Fan Wattage	Light Wattage
LSA0807	425 x 360 x 216	4 x 275W	1145W	30W	15W CFL (R80)
LSA0809	410 x 350 x 216	4 x 275W	1145W	30W	15W CFL (R80)
LSA309	418 x 225 x 212	2 x 275W	591W	30W	11W CFL (R63)



AP-275W

AP-275W Spare 275W heating lamp

Features include:

- Extraction fan duct size: 100mm.
- Powerful infrared heat lamps provide instant heating.

- Energy Saving, dual heat settings on 4 lamp units
- c/w multi-function wall switch.

DOMESTIC & INDUSTRIAL FANS

NEW RANGE



FW-1

FW-2



CH-1686
CH-1640RF (with remote control)

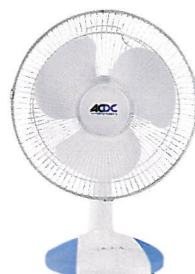

FT-40/FD30-FQY-C



FB3001
FB2501

Wall Mounted Fans

Code	Description
FW-1	16" 3 speed wall mount fan with on/off wall cord
FW-2	16" 3 speed wall mount fan with remote control and 0.5-7.5 hour timer

Floor Standing Fans

CH-1686	16" 3 speed floor standing fan
CH-1640RF	16" 3 speed floor standing fan with remote control & 8 hour timer

Desktop Fans

FT-40	16" 3 speed desktop fan
FD30-FQY-C	12" 3 speed desktop fan

Desktop (Box-Type) Fans

FB3001	12" 3 speed floor standing fan
FB2501	10" 3 speed floor standing fan

Industrial Fans (3 Speed with Aluminium blades)

Size	Floor No Oscillation	Wall with Oscillation		Pedestal With Oscillation
		Directly Connected	With Remote	
18"	CH-V18	CHW-V18	CHW-V18R	CH-S1871
20"	CH-V20	CHW-V20	CHW-V20R	CH-S201
24"	CH-V24	CHW-V24	CHW-V24R	CH-S241



Floor



Wall



Pedestal

GAS PATIO HEATERS

Accessories Included



5/8 SA LPG Regulator



Gas Hose 0.5m with 2 Clips



K/D Wheels

NEW



Stainless Steel



Silver



White



Black

Code	RW-GH-01	RW-GH-02	RW-GH-03	RW-GH-04
Description	Stainless Steel Gas Patio Heater	Silver Mild Steel Gas Patio Heater	White Mild Steel Gas Patio Heater	Black Mild Steel Gas Patio Heater
Height (mm)	2210mm	2210mm	2210mm	2210mm

DOMESTIC & INDUSTRIAL FANS

Ceiling Fans

Code	Description
HS-36-R	White 3 blade with remote controller, 3 speed fan control, 1-9 hour fan turn off timer, light on/off, dimmer and 3 minute off delay timer
HS-36-W	White 3 blade with wall controller and light
HS-36-GLASS	Spare light cover for HS-36-R & W
HS-37	White 3 blade with wall controller no light
HS-5301	White 4 blade with wall controller no light
HS-5301-L	White 4 blade with wall controller and light
HS-5301-GLASS	Spare light cover for HS-5301-L
HS-5301-CN	Spare wall mount Speed Controller for HS-5301
FD2-5-1200*	Three blade with wall controller, no light 1200mm
FD2-5-1400*	Three blade with wall controller, no light 1400mm

*Add colour to code: **WH** (White) or **BK** (Black)



HS-36-R



HS-5301



HS-37

NEW
NEW



HS-5301-CN



FD2-5-1200



FD2-5-1400

DECORATIVE CEILING FANS

Supply Voltage:
230V 50Hz

NEW

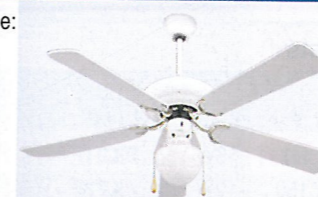

WS52-5CL



WS52-5C4L



WS52-5C1L



WH48TU

Code	WS52-5CL	WS52-5C4L	WS52-5C1L	WH48TU
Lights	1 x E27	4 x E27	2 x E27	-
Blades	5 (wood)	5 (wood)	5 (wood)	3 (steel)
Size	52" (1321mm)	52" (1321mm)	52" (1321mm)	48" (1220mm)

All of the above fans come with 3-speed pull chain control and are reversible.

Spares

Code	Description	Code	Description
WS-3SPS	Spare 3-step pull switch	WS-3SPS	
WS-PS	Spare light pull switch	WS-PS	
		WS-CAP	Spare AC starting capacitor

NEW RANGE



OW301



HS-36-REMOTE



AS-CF118N

Transmitter & Receiver for Fans (Frequency: 433.92MHz)

Code	Description
OW301	Transmitter (Remote) and receiver. 3 Speed fan control, reversibility and light on/off
HS-36-REMOTE	Transmitter (remote) and receiver. 3 speed fan control and 1-9 hour fan turn off timer. Light on/off with dimmer and 3 minute off delay timer.
AS-CF118N	Transmitter (remote) and receiver, 3 speed fan controller with fan on/off. Light on/off.
AS-CF125N	Transmitter (remote) and receiver, 3 speed fan controller with fan on/off. Light on/off and dimmer.
AS-CF130N	Transmitter (remote) and receiver, 3 speed fan controller with fan on/of. Light on/off and dimmer. Delay off function. Temperature compensation, Timer LCD monitor.



AS-CF125N

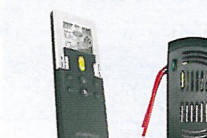

AS-CF130N

FANS

• Ball Bearing – long life • Wires to terminals

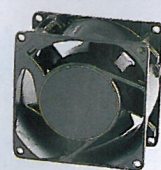

Size	80x80x25	80x80x38	92x92x25	120x120x38	172x150x50
m³/h	53		78	160	
dB	34		31	41	
DC Fan	12VDC	AD0812MB-A70	AD0912MB-A70	AD1212MB-F51	AD1712MB NEW
	24VDC	AD0824MB-A70	AD0924MB-A70	AD1224MB-F51	AD1724MB NEW
	48VDC	AD0848MB-A71	AD0948MB-A70	AD1248MB-F51	AD1748MB NEW



Size	80x80x25	80x80x38	92x92x25	120x120x38	172x150x50
m³/h		25	39	157	315
dB		18	21	44	50
AC Fan	115VAC	AA8381MB-AT	AA9251MB-AT	AA1281MB-AT	AA1751MB-AT
	Ball Bearing 230VAC	AA8382MB-AT	AA9252MB-AT	AA1282MB-AT	AA1752MB-AT



Size	80x80x25	80x80x38	92x92x25	120x120x38	172x150x50
Sleeve Type 230VAC	SF8080-2	SF9292-2	SF120120-2		

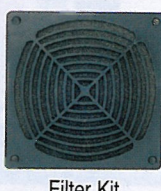

Accessories	80x80x25	80x80x38	92x92x25	120x120x38	172x150x50
Chromed steel finger guard	AFG0805	AFG0805	AFG0906	AFG1207	AFG1758
Plastic finger guard	PFG0805	PFG0805	PFG0906	PFG1207	PFG1758
Filter Kit c/w Low Density non-woven fabric filter	APF08L	APF08L	APF09L	APF12L	-

Econo Fans for Electrical Cabinets

Code	Flow Rate	Size H x W	Watts	Spare Filter	Outlet Grill c/w filter
FK3321.100	50m³/h	117 x 117	16W	FK21F	FK3321
FK3322.100	55m³/h	150 x 150	19W	FK22F	FK3322
FK3323.100	105m³/h	204 x 204	19W	FK23F	FK3323
FK3325.100	230m³/h	255 x 255	41W	FK25F	FK3325
FK3326.100	495m³/h	323 x 323	64W	FK26F	FK3326
FK7726.230	1610m³/h	325 x 325	115W	FK76F	FK7726

Fans complete with grill and filter. Outlet grill to be ordered separately

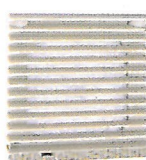

Fan

Grill

Ceiling Fans

Code	Performance	Watts	Size	Pipe Outlet Ø	Colour
BPT12-13A-B	140m³/h	18	255 x 255mm	100mm	White
BPT12-13B-B	180m³/h	24	290 x 290mm	100mm	White
BPT12-13A-D	140m³/h	18	255 x 255mm	100mm	White
BPT12-13B-D	180m³/h	24	290 x 290mm	100mm	White
BPT12-13A-J	140m³/h	18	255 x 255mm	100mm	Silver
BPT12-13B-F	180m³/h	24	290 x 290mm	100mm	Silver
BPT12-13A-H	140m³/h	18	255 x 255mm	100mm	Silver
BPT12-13B-E	180m³/h	24	290 x 290mm	100mm	Silver

Wall/Window Fans

Code	Performance	Watts	Size H x W x Ømm
APC13A-9	130m³/h	12	150 x 150 x 100
APC13A-11	220m³/h	15	180 x 180 x 120
APC13A-13	320m³/h	18	210 x 210 x 150

Window Fans

Code	Performance	Watts	Size H x W x Ømm
APB20B	500m³/h	20	305 x 305
APB25B	800m³/h	20	350 x 350

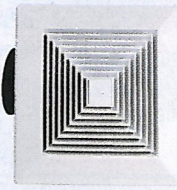

BPT12-13A-B
BPT12-13B-B



BPT12-13A-D
BPT12-13B-D

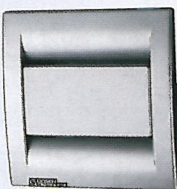

BPT12-13A-J
BPT12-13B-F

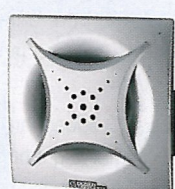

BPT12-13A-H
BPT12-13B-E



APC13A-9/11/13



APB20/25B

FANS

Use O.erre fan selection software to select the right fan for your application!

Systema Series

240V fan c/w grill and filter plus separate outlet grill and filter for electrical cabinets. Ambient temperature range: -20° to +50°C. Motor with ball bearings rated for 30 000 hours.

Code	IP Rating	Flow Rate	Watts	Size H x W	Spare Filter (set of 4)	Spare Grilles
OW976	IP44	42m³/h	17	130 x 130	OW962	OW965
OW978	IP44	110m³/h	30	250 x 250	OW968	OW951
OW992	IP54	85m³/h	30	250 x 250	OW991	OW951
OW979	IP44	130m³/h	30	320 x 320	OW963	OW966
OW980	IP55	58m³/h	35	320 x 320	OW964	OW966
OW981	IP44	360m³/h	35	320 x 320	OW963	OW966
OW982	IP55	136m³/h	35	320 x 320	OW964	OW966

Systema Series - 110VAC

OW989	IP44	360m³/h	35	320 x 320	OW963	OW966
OW970	Thermostat (20 to 60°C) For DIN rail mounting inside cabinet					

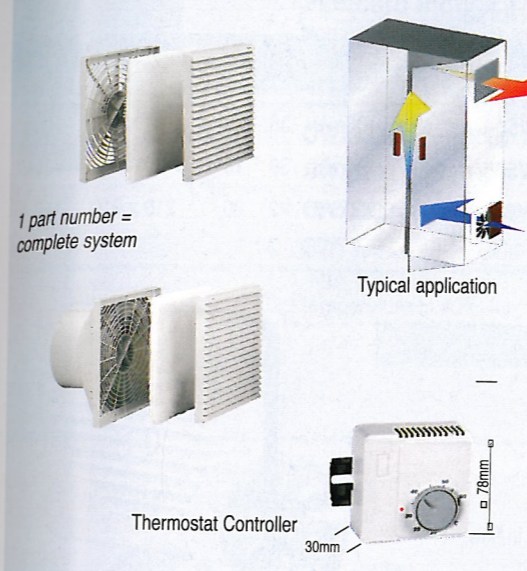

Smart Commercial Fans

For window, wall or panel mount, domestic and commercial fans. 230V

Code	Model	Shutter	Colour	Flow Rate	Watts	Size H x W x D
OW727	Smart 15/6(A)	Auto	White	230m³/h	30	215 x 215 x 100
OW720	Smart 23/9 (AR)	Auto	White	750m³/h	40	331 x 321 x 141
OW721	Smart 23/9 (M)	Manual	White	750m³/h	40	331 x 321 x 141
OW725	Smart 23/9 (AR Silent)	Auto	White	500m³/h	30	331 x 321 x 141
OW714	Smart 30/12 (AR)	Auto	White	1350m³/h	75	375 x 385 x 148
OW713	Smart 30/12 (AR Silent)	Auto	White	1000m³/h	45	375 x 385 x 148
OW718	Smart 30/12 (AR Wifi)	Auto	White	1400m³/h	60	375 x 385 x 148
OW795	Double Window Kit for Smart 23/9					
OW799	Double Window Kit for Smart 30/12					
OW798	Wall Mounting Kit					
OW315	3 Speed Controller and reversible (page 414)					

• (AR) = Auto Shutter Reversible • () = Wireless Radio Control

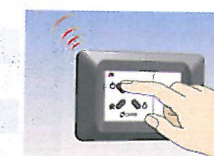

Wifi wireless controller

Intra Ceiling Extractor Fans • Fan easily removable for cleaning • Quiet running

Code	Model	Flow Rate	Watts	Size H x W	Pipe Ø
OW918	INTRA 100	95m³/h	30	260 x 242	97
OW920	INTRA 300	270m³/h	45	270 x 320	97

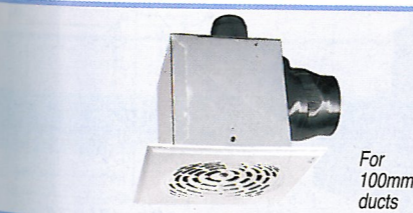

For 100mm ducts

Standardmatic Series

• Axial wall fans with silent automatic shutter • Easy clean ABS Material

Code	Models	Flow Rate	Watts	Size H x W	Pipe Ø
OW166	Standardmatic 10	90m³/h	21	154 x 150	98
OW168	Standardmatic 12	130m³/h	23	174 x 174	118
OW170	Standardmatic 15	230m³/h	36	210 x 210	146

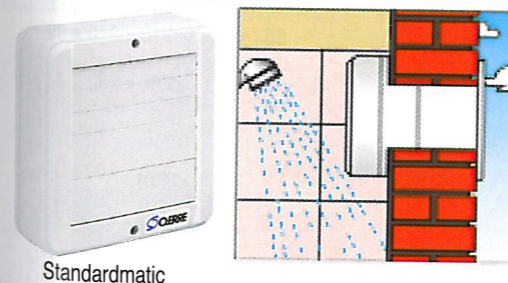

Standardmatic

Grills and Gravity Shutters Rain proof grills. Fitted on external wall

Grill	Size H x W x Ø	Shutter	Size H x W x Ø
OW800	154 x 154 x 99	OW801	149 x 149 x 99
OW802	154 x 154 x 119	OW803	149 x 149 x 119
OW907	208 x 208 x 151		

Rain proof shutters to prevent entry of air when fan is switched off. Shutters open automatically with air flow when the fan is working.

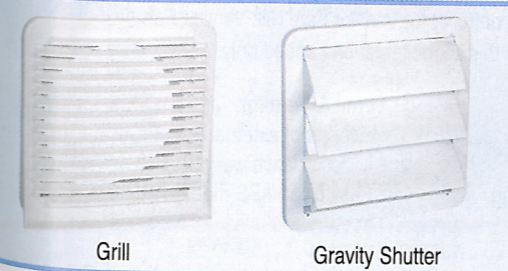

Grill

Gravity Shutter

Use O.erre fan selection software to select the right fan for your application!

FANS

2 YEAR GUARANTEE *in* SERIES



In Series - Low Profile - Low Noise

Code Standard	D mm	Metal Bearing	With Auto Shutters	D mm	Flow Rate	db	Watts	Size H x W	Pipe Ø
OW501	20	-	OW504	43	105m³/h	36	13	160 x 160	100
OW502	20	-	OW505	43	180m³/h	39	18	180 x 180	120
OW503	20	OW527	OW506	43	330m³/h	42	30	210 x 210	150

In Series Window Kits

Code	Description
OW591	For Fan OW501
OW592	For Fan OW502
OW593	For Fan OW503



Slimline design with high performance in flow, low dB & low power consumption

Standard and Mini Series CE

• Axial fans. Wall, ceiling or panel mounting • ABS Material • Splash Proof

Code	Models	Flow Rate	Watts	Size H x W	Pipe Ø
OW847	Standard 8	35m³/h	15	123 x 123	75
OW157	Standard 10	88m³/h	21	154 x 154	98
OW158	Standard 12	125m³/h	23	174 x 174	118
OW161	Standard 15	230m³/h	36	210 x 210	146
*OW121	Mini 10 Sensor	85m³/h	14	154 x 154	100
*OW122	Mini 12 Sensor	125m³/h	21	174 x 174	120
OW137	Mini 10	85m³/h	14	154 x 154	100

*Infrared sensor for auto start of fan when room is occupied

Ventilator Series CE

Code	Models	Flow Rate	Watts	Size H x W x D
Window fans with manual shutter. Glass up to 5mm				
OW841	Ventil 12	100m³/h	20	174 x 174 x 74
OW842	Ventil 15	155m³/h	30	210 x 210 x 99
OW188	Ventilator 20/8M	450m³/h	50	280 x 280 x 94

Automatic window fans without controller. Panel/Glass up to 50mm

OW190	Ventilator 20/8AR	450m³/h	50	280 x 280 x 94
OW192	Ventilator 25/10AR	750m³/h	60	335 x 335 x 280
OW191	Wall fixing kit for Ventilator			

OW315 3 speed reversible controller for Ventilator Fan. NB: Ventilator Fan can operate without this controller, at one speed only.

Ventilator:

- 5 speed, reversible.
- Silent shutter operation.
- OW188 manual shutter. Non reversing.
- OW190/ OW192 auto shutter.

Ventil & Ventilator:

- Rain proof external grill.
- In accordance with IEC 342-1.
- Easy clean ABS material.

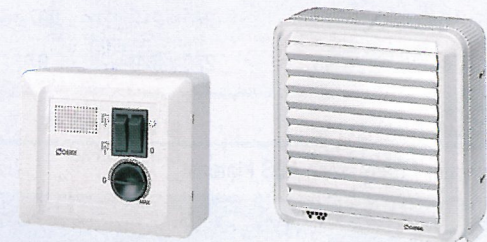

Controller OW315 Ventilator
Ventilator shutter can be left open to provide natural ventilation

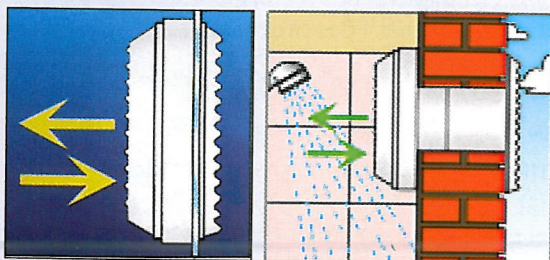

Use O.erre fan selection software to select the right fan for your application!

FANS

Standard Industrial Axial Fans CE

Non-corrosive impeller. 230VAC



Fan



Grill

Economy* Code IP42	W	Flow Rate	Med. Duty* Code IP55	kW	Flow Rate	Explosion Proof Fans	kW	Flow Rate	Size (mm) H x W x Ø	Grill Code
OW73301	30	550m³/h	-	-	-	-	-	-	280 x 280 x 208	OW594
OW73302	55	1100m³/h	OW73001	0.08	1200m³/h	OW354	0.12	900m³/h	340 x 340 x 260	OW595
OW73303	70	1400m³/h	OW73003	0.1	1800m³/h	OW355	0.14	1500m³/h	390 x 390 x 312	OW596
OW73304	72	1700m³/h	OW73005	0.125	2400m³/h	OW356	0.16	2250m³/h	460 x 460 x 365	OW597
			OW73007	0.155	3500m³/h	OW350	0.18	2900m³/h	510 x 510 x 415	OW598
			OW73011	0.29	6200m³/h	OW351	0.21	4500m³/h	630 x 630 x 515	OW599
						OW361*	0.23	2900m³/h	510 x 510 x 415	OW598

*Max operating temperature is 40°C

*Max operating temperature is 60°C

*OW361 is a 3-phase 400VAC unit. Explosion proof fans Ex-Atex Approved N.03 Atex 251

TB Series

In-line Axial Duct Fans. 230V



Code	Model	Flow Rate	Watts	Size W x Ø
OW184	TB10	80m³/h	15	97 x 96
OW194	TB12	130m³/h	15	97 x 116
OW195	TB15	250m³/h	25	113 x 147

Centrifugal In-Line Duct Fans - Zinc plated steel body. IP44 max. temp 55°C



Code	Flow Rate	Outlet Size Ø	Watts	Gravity Shutter	Duct Clamp
OW370	270m³/h	98	75	OW622	OW614
OW373	400m³/h	123	75	OW623	OW615
OW376	500m³/h	148	75	OW621	OW616
OW379	710m³/h	158	90	OW621	OW620
OW381	1050m³/h	198	180	OW625	OW617
OW383	1200m³/h	248	180	OW626	OW618
OW384	1400m³/h	313	280	OW627	OW619

Centrifugal Duct Fans Type CB

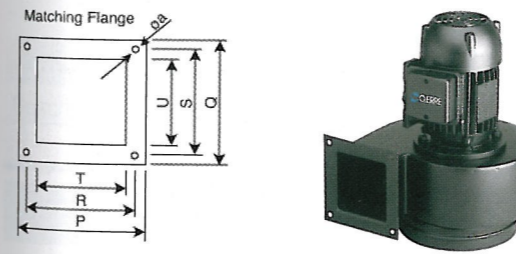

Code	Volts	KW	Flow Rate	Flange Size						
				P	Q	R	S	T	U	
OW410	230V	0,067	210m³/h	100	100	85	85	58	58	
OW412	230V	0,115	380m³/h	114	110	95	90	69	63	
OW414	230V	0,59	1000m³/h	135	135	114	114	88	88	
OW416	230V	0,85	1450m³/h	135	135	114	114	88	88	
OW417	400V 3Ø	0,85	1450m³/h	150	150	125	125	105	105	

Centrifugal Roof Fans 80°C IP55



Code	Volts	kW	Flow Rate	Size W x D x H	Gravity Shutters
OW408	230V	0,065	1000m³/h	410 x 410 x 213	-
OW409	230V	0,145	1550m³/h	410 x 410 x 213	-
OW741	230V	0,12	1200m³/h	408 x 408 x 487	OW786
OW742	230V	0,18	1800m³/h	408 x 408 x 527	OW787
OW743	230V	0,25	3100m³/h	408 x 408 x 539	OW788
OW776	230V	0,90	5000m³/h	761 x 761 x 756	OW770
OW765	400V	0,75	7000m³/h	761 x 761 x 833	OW770
OW766	400V	1,1	11000m³/h	860 x 860 x 918	OW771
OW767	400V	2,2	22000m³/h	860 x 860 x 973	OW771

Centrifugal Roof Fans for Hot Fumes 200°C IP54 (Turbocamino)

Used for fireplaces, ovens or industrial hoods.

OW554	230V	0,11	1200m³/h	475 x 475 x 470	
-------	------	------	----------	-----------------	--

NEW

FANS

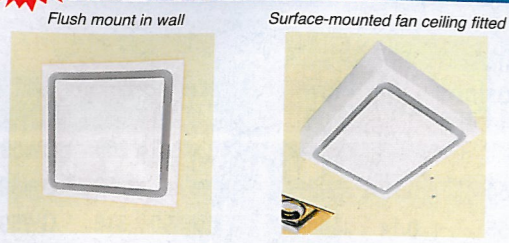

Diverso Series - Centrifugal Wall or Ceiling Fans

Code	Model	Flow Rate	Watts	Dimensions (mm)
Flush mount unit - Built into wall or ceiling.				
OW826	Diverso in 80	90/80*	28	244 x 244 x 130
OW829	Diverso in 160	190/170*	50	300 x 300 x 160
OW833	Diverso in 240 T#	270/240*	80	300 x 300 x 160
OW834	Diverso in 240 HT#	270/240*	80	300 x 300 x 160
Surface mount units - Surface mount on wall or ceiling with rear exit				
OW817	Diverso 80	80	28	244 x 244 x 117
OW820	Diverso 160	170	50	300 x 300 x 148
OW824	Diverso 240 T#	240	80	300 x 300 x 148
OW825	Diverso 240 HT#	240	80	300 x 300 x 148

* flow rate for upper/ rear outlet
T = unit with timer
HT = unit starts automatically when humidity level increases

Specially designed grill to avoid dust deposits on walls. **IPX5** rating allows unit to be installed in humid environments. Balancing grill allows easy removal of filter

Recessed Wall Kit

OW82610	To fit OW826
OW82910	To fit OW829, OW833, OW834

To provide for future installations of DIVERSO IN. c/w temporary insert to keep out mortar or plaster.

Outdoor IPX5 - Centrifugal extractor fan for outdoor installation

OW56100	CO100	280m³/h	55	260 x 306 x 114
OW56200	CO150	350m³/h	60	260 x 306 x 114

• Operating temperature range: -20° to 70°C • Duct Size: Ø96-149mm
Outdoor is a very quiet running fan with a long-lasting ball bearing motor. External installation provides even quieter operation

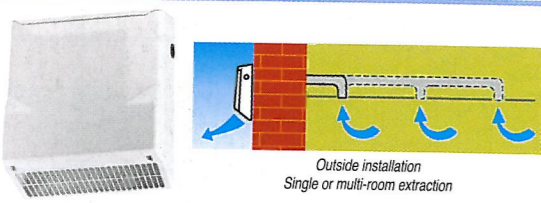

INDUSTRIAL EXHAUST FAN



NEW

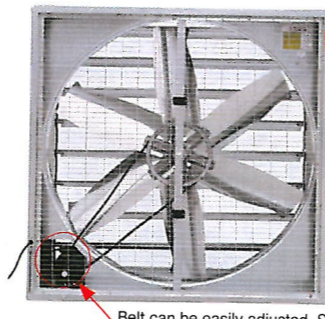
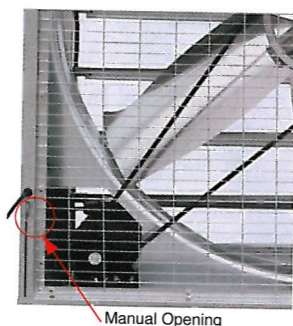
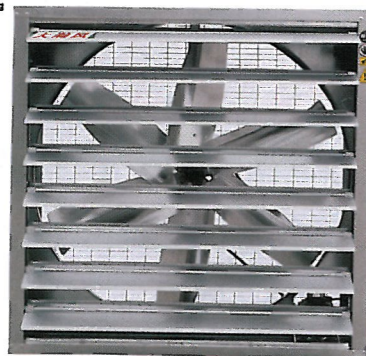

Manual Opening

Belt can be easily adjusted. Safe and fast maintenance.

Code	DHF-1	DHF-2	DHF-3	DHF-4	EOS-2	EOS-3
Fan diameter (mm)	1270	1110	950	790	1270	950
Rotary Speed (rpm)	450	480	500	520	450	500
Air Flow (m³/h)	44500	37000	32000	28000	44500	35000
Noise dB(A)	68	65	60	55	60	50
Power (kW)	1.1	0.75	0.55	0.37	1.1	0.55
Rated Voltage (V)	380	380	380	380	380	380
Weight (kg)	80	60	55	50	95	70
Outside Dimensions (mm)	1380 x 1380 x 400	1220 x 1220 x 400	1060 x 1060 x 400	900 x 900 x 400	1380 x 1380 x 500	1000 x 1000 x 500
Frequency	50Hz	50Hz	50Hz	50Hz	50Hz	50Hz
Motor	3 phase	3 phase	3 phase	3 phase	3 phase	3 phase
Applicable area (m²)	100	80	50	30	100	70
Fan Body Material	galvanized sheet	galvanized sheet	galvanized sheet	galvanized sheet	fibre glass	fibre glass
Fan Blade Material	aluminium (2mm)	aluminium (2mm)	aluminium (2mm)	aluminium (2mm)	plastic	plastic

NEW RANGE

VENTILATION KITS



Code	NVVKO1K-100/3	NVVKO1K-125/3	NVVKO1K-150/3	NVTT-100/3	NVTT-200/6
Flow Rate	107m³/h	190m³/h	305m³/h	123.5m³/h	870.7m³/h
Duct Size	Ø100mm	Ø125mm	Ø150mm	Ø100mm	Ø200mm
Kit includes:	<ul style="list-style-type: none"> • VKO1k 100mm Axial in-line • Fan with bracket • 2 x Grills (154 x 154mm) • 100mm plastic connector with black valve • 3m plastic flexible duct • 6 x hose clamps 	<ul style="list-style-type: none"> • VKO1k 125mm Axial in-line • Fan with bracket • 2 x Grills (187 x 187mm) • 125mm plastic connector with black valve • 3m plastic flexible duct • 6 x hose clamps 	<ul style="list-style-type: none"> • VKO1k 150mm Axial in-line • Fan with bracket • 2 x Grills (221 x 299mm) • 150mm plastic connector with black valve • 3m plastic flexible duct • 6 x hose clamps 	<ul style="list-style-type: none"> • TT 100 in-line fan • Disk valve Ø100mm • Grill with gravity shutters (154 x 154mm) • 3m aluminium-laminated flexible duct • 10m duct tape (50mm) 	<ul style="list-style-type: none"> • TT 200 in-line fan • Disk valve Ø200mm • Grill (250 x 250mm) • 3m alu-laminated flexible duct • 4 x hose clamps

Duct Fans

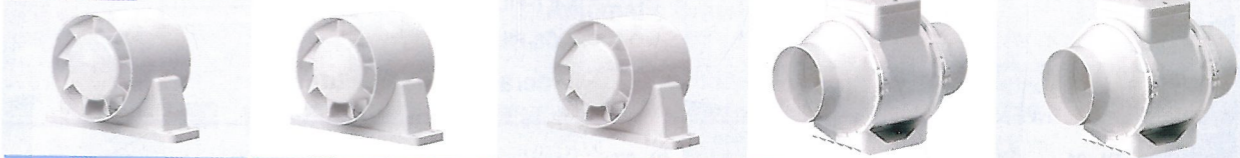

Code	VKO1K-100	VKO1K-125	VKO1K-150	TT-100	TT-200
Description	Axial in-line duct fan	Axial in-line duct fan	Axial in-line duct fan	In-line duct fan	In-line duct fan
Flow Rate	107m³/h	190m³/h	305m³/h	123.5m³/h	870.7m³/h

Accessories



Code	A*-VRF	MV*	MV*-J	AFC-*.†	CZN-*
Description	Plastic Disk valve	Grill	Gravity Shutter	Alu-laminated flexible duct	Hose clamps

*Add duct size in mm to code: 100, 125, 150, 200

†Add length of duct to code: 1M, 3M, 5M

INSTANT WATER HEATERS

S-Series IP24

• Supply voltage: 230VAC 50Hz
• Easy installation and use
• c/w shower head and mixing valve
• Temperature of water: 30-50°C (depending on local temperature)



P-Series IP24

• Supply voltage: 230VAC 50Hz
• Large LED display for water temperature
• Electronic temperature control (4 Power settings)
• Maximum Temperature: 53°C



Code	Power	Pressure	Flow/min	Code	Power	Pressure	Flow/min
DZR-CY5S1	5.5kW	0.14-0.6MPa	2.7ℓ	DZR-CY6P	6kW	0.02-0.8MPa	3.2ℓ
				DZR-CY8P	8kW	0.02-0.8MPa	4.2ℓ

FANS, INSECT PROTECTION & HYGIENE

FANS, INSECT PROTECTION & HYGIENE

WATER DISPENSERS



Cold & Hot Water Dispensers – White

Code	Features
DY721	Desktop, 630W, Electronic Cooling type
DY025	Floor standing with storage, 630W, 970mm(H), Compressor Type

Standard Water Bottles

WATER-BOT10	10 litre bottle for water dispenser
WATER-BOT19L	19 litre bottle for water dispenser

Floor Standing Coffee Maker Using Powder Coffee

X-68CF-B	Hot & cold water dispenser with built-in coffee maker. Heating power 1100kW
----------	---



Water Purifiers with built-in Filter

Code	Litres	Filtration
X-C5	12 ltr.	5 layers of activated carbon with 1 ceramic filter
X-C7	10 ltr.	5 layers of activated carbon without ceramic filter
X-C8	20 ltr.	5 layers of activated carbon with 3 ceramic filters

Spare Filters

X-C5-FILTER	<ul style="list-style-type: none"> Fits on Standard Hot & Cold water dispensers Turns ordinary tap water into pure, healthy water
X-C7-FILTER	
X-C8-FILTER	

Mineral Pot Water Purifiers

Code	Litres
GL-01	20 ltr.
GL-018	20 ltr.
GL-07	24 ltr.
GL-FILTER	Spare filter for GL-Series



WATER PURIFIERS

Under Counter Type



Code	X-JS10-G1	X-JS10-G2	X-JS10-G3
Filtration	PPF	PPF + UDF	PPF + UDF + CTO
Source water TDS	≤300 PPM	≤300 PPM	≤300 PPM
Operating Temp	5~40°C	5~40°C	5~40°C
Source Water Pressure req.	0.1 - 0.6MPa	0.1 - 0.6MPa	0.1 - 0.6MPa
Rated Purification Capacity	2000l	2000l	2000l



Spare Filters

Code	Description
X-PP1001	PPF-sediment filter; removal of sand silt, dirt and rust particles.
X-UDF1001	UDF - Reduction of odour, taste, chlorine and halides, deleterious substances, Fe, Hydroxybenzene, As, Hg, Al, CHC13, CC14.
X-CTO1001	CTO - Reduction of odour, taste, chlorine and halides, common organic matter and micro-organisms, extremely tiny particles, suspended substances and colloids.
X-FH1001	Combination filter for use in single element system.

HYGIENE PRODUCTS

Cold Water Electric Taps IP56



Cold water units can operate on mains or battery power

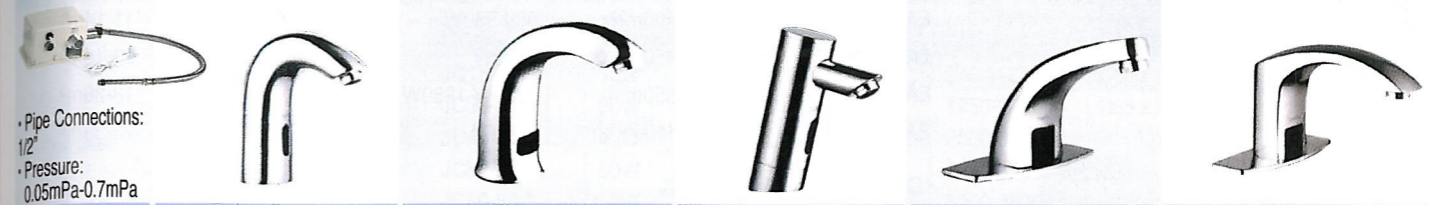

Code	TWS-306LT	TWS-102LT-2	TWS-302LT	TWS-103LT	TWS-105LT
------	-----------	-------------	-----------	-----------	-----------

Hot & Cold Water Electric Taps IP56

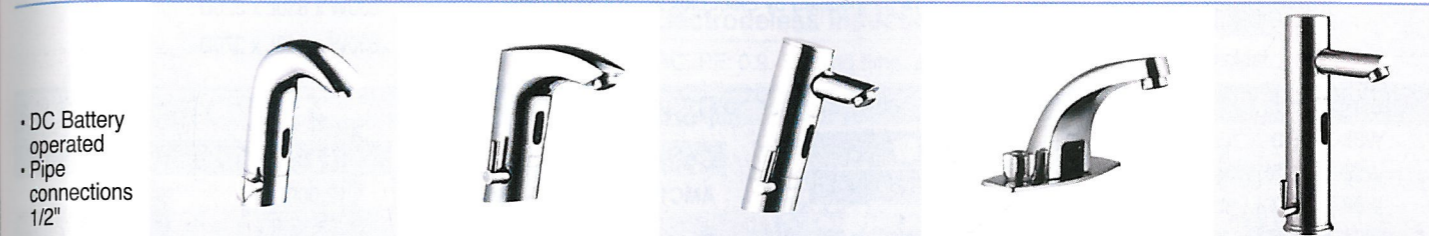

Code	TWS-307LT	TWS-602LT	TWS-305LT	TWS-303LT	TWS-308LT
------	-----------	-----------	-----------	-----------	-----------

Automatic Urinal Flusher IP56

Supplied c/w 230V control valve

Code	Pipe Inlet Size	Pressure	Detection Zone	Size
S-813	1/2"	0.05mPa-0.7mPa	600mm	122 x 148mm
S-855	1"	0.05mPa-0.7mPa	600mm	122 x 122mm

Automatic Air Freshener



S921

- Mode: Day, Night, 24 hrs
- Interval: 15/30/60 minutes
- Supply: 2xAA batteries (not supplied)
- Uses standard aerosol

Paper Towel Dispensers



S931
Folded Towels

S932
Paper Roll

Hand Dryer

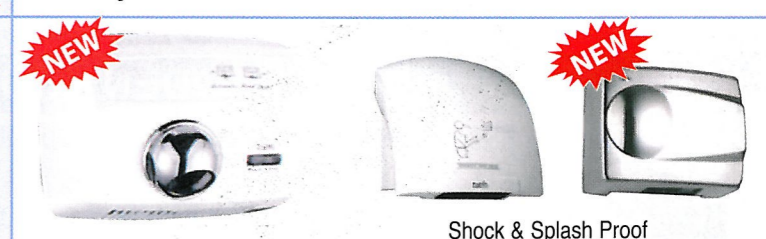

TWS-2900GS

1800W 230VAC
Detection: 200mm
Temperature: 65-75°C
Duration: 5s
290 x 240 x 230mm
Wind Speed: 30m/s

DS02100E

1800W 230VAC
Detection: 50-200mm
Temperature: 50±5°C
Duration: 5s
250 x 238 x 230mm
Wind Speed: 16m/s

TWS-2600GS

1800W 230VAC
Detection: 200mm
Temperature: 65-75°C
Duration: 5s
265 x 205 x 125mm
Wind Speed: 12m/s

Hair Dryer

Code	DS809B
W & V	1250W 230V
Size	115 x 230 x 95mm

Liquid Soap Dispenser



LSD-1

- Manual operation.
- 1,8 litre capacity

TWS-6680ZY

- Motion Activated
- 3-Speed Setting
- 500ml
- Battery operation 4 x AA (not incl.)

ASD-111

- Stainless Steel
- 800ml capacity
- 4 x AA Batteries
- With lock & key
- Touch-free

FD-923

- Satin Finish
- 1200ml capacity
- Non-corroding valve
- Unbreakable polycarbonate window

Pedal Bin



BLF1200R

12l
Ø250 x 390mm

Automatic Trash Can



DZT-31-8

31l
Ø335 x 525mm,
4x C-Batteries (not incl.)