

ENCLOSURES

D.M.C. Polyester Utility Enclosures. IP65
Gasketed lid secured by four screws

Code	Dimensions H x W x D
UT2	110 x 110 x 90
UT4	210 x 160 x 90
UT6	260 x 210 x 125
UT8	310 x 260 x 165



MP-X

D.M.C. Enclosures. IP54 General purpose utility box with removable lid secured by four screws

Code	Description	Size H x W x D
MP-X	3mm DMC with rubber gasket	120 x 80 x 55
MP-A	3mm DMC with rubber gasket	170 x 105 x 70
MP-B	3mm DMC with rubber gasket	205 x 155 x 70
MP-C	3mm DMC with rubber gasket	305 x 205 x 110

Reticulation Type Distribution & Meter Boxes. Weatherproof

PPS-1	Bundle Conductor box	312 x 193 x 120
SMB-1	Single Phase meter box	345 x 263 x 169
PPS-3	ECU meter box (U7)	330 x 325 x 161
UB-4	As per WP-1 without insert	315 x 185 x 120

Outdoor Utility Box with sliding lid and slot for plug cable

Code	Description	Material	Size W x H x D
ASO-1	15A Plug Socket Outlet (not included)	PVC	140 x 100 x 75
PSO-1	15A Plug Socket Outlet (not included)	Fibre re-inforced	130 x 90 x 80
PSO-2	Double Plug Socket Outlet (not included)	Fibre re-inforced	175 x 130 x 90

Utility Box • Screw on lid • Cable entry knock-outs • Extra deep design

Code	Description	Size W x H x D
UB-3	Weather proof box IP65	233 x 173 x 205

Pool Boxes for DIN

Code	Description	Size W x H x D
POOL-BOX	Grey Pool Box with screw on Lid IP40	220 x 160 x 205
WP-1	Upward sliding lid, Din Rail included – no locking mechanism IP65	365 x 135 x 215
WP-2	Upward sliding lid, Din Rail included c/w 16A plug	205 x 325 x 123
EFSB-01	Pole-mount SMC Junction Box IP65	140 x 140 x 100

ELECTRONIC INSTRUMENTATION ENCLOSURES

INC BOX	36 x 72	48 x 48	48 x 96	72 x 72	96 x 96	144 x 144
Material: Noryl Black UL94V-0						
Size	36 x 72	48 x 48	48 x 96	72 x 72	96 x 96	144 x 144
Depth 57mm	01.107.L057	01.108.L057	01.109.L057	01.110.L057	01.111.L057	01.509.L057
Depth 100mm	01.107.L100	01.108.L100	01.109.L100	01.110.L100	01.111.L100	01.509.L100
Front Panel Aluminium	06.291	06.292	06.293	06.294	06.295	06.298
Front Panel Noryl Black	06.251	06.252	06.253	06.254	06.255	06.258
Front Panel, Plexiglass Red, transparent	06.200	06.201	06.202	06.203	06.204	06.207
Rear Panel Noryl Black	06.271	06.272	06.273	06.274	06.275	06.376 (PVC)
Protection Cover IP54	–	–	03.432	03.433	03.434	03.436



Front ALU Plate

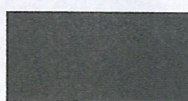

FR/RR Plate

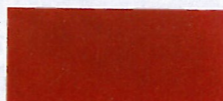

Front Red Plate

ENCLOSURES

Project Boxes with flanges for wall mounting, moulded in high impact styrene with screws, lid and slots for PC Boards. IP42

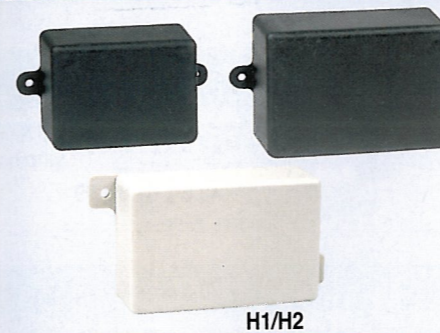

H1/H2

Code Black	Code Grey	Code Beige	Size L x W x H
A0-B	A0-G	–	74 x 54 x 37
A1-B	A1-G	–	94 x 65 x 42
A2-B	A2-G	–	114 x 74 x 52
A3-B	A3-G	–	134 x 85 x 52
H1-B	–	H1-BG	85 x 56 x 30
H2-B	–	H2-BG	99 x 59 x 26

Project Boxes moulded in high impact styrene with screws and lid. With or without internal ribs for PC Boards. IP42

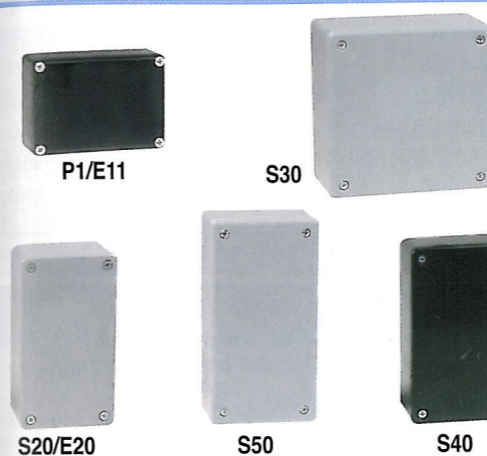

P1/E11

S30

S20/E20

S50

S40

Code Black without Ribs	Code Black with Ribs	Code Grey without Ribs	Code Grey with Ribs	Size L x W x D
P1-B	–	P1-G	–	70 x 50 x 25
E11-B	–	E11-G	–	112 x 62 x 25
S10-B	S10-BR	S10-G	S10-GR	85 x 56 x 30
S20-B	S20-BR	S20-G	S20-GR	130 x 70 x 44
S30-B	S30-BR	S30-G	S30-GR	105 x 105 x 50
S40-B	S40-BR	S40-G	S40-GR	150 x 90 x 55
S50-B	S50-BR	S50-G	S50-GR	195 x 110 x 60
E20-B	–	E20-G	–	111 x 60 x 40

RP Series IP65

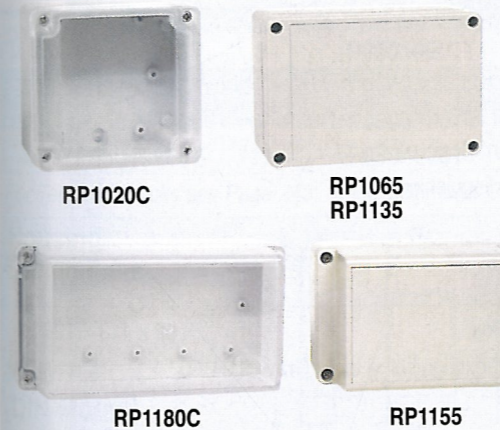

RP1020C

RP1065
RP1135

RP1180C

RP1155

Polycarbonate Clear Lid	Polycarbonate Grey Lid	ABS Grey Lid	Size L x W x H
RP1020C	–	RP1025	65 x 60 x 40
RP1060C	–	RP1065	85 x 80 x 55
RP1130C	–	RP1135	125 x 85 x 55
RP1150C	–	RP1155	125 x 85 x 85
RP1170C	–	RP1175	165 x 85 x 55
RP1180C	–	RP1185	165 x 85 x 85
RP1240C	–	RP1245	165 x 125 x 75
RP1280C	–	RP1285	186 x 146 x 75
G256C	G256	–	82 x 80 x 55
G258C	G258	–	160 x 80 x 55
G269C	G269	–	200 x 120 x 75

Polycarbonate clear lids with UV stabilized

Accessory: Wall-Mounting Feet

ABS, in Light Grey colour, supplied with Wall Plugs and fixing screws.
MF0041 4 pcs per supply pack.

Aluminium EL Box Series IP65



RP1245

RP1285

Natural

Grey

Code Natural	Code Grey RAL7035	Size L x W x H
G102	G102P	90 x 36 x 30
G104	G104P	64 x 58 x 35
G106	G106P	115 x 65 x 30
G111	G111P	115 x 65 x 55
G113	G113P	115 x 90 x 55
G115	G115P	148 x 108 x 75
G120	G120P	171 x 121 x 55
G124	G124P	222 x 146 x 55

SPECIAL ELECTRONIC ENCLOSURES

DIN Mount Enclosures

Code	Description	Size W x L x D
DB-6T	6 Terminal	22.5 x 81.8 x 99
DB-12T	10 Terminal	43.6 x 81.8 x 99
BS6-2T	10 Terminal	70 x 65 x 112
BS10-2T	20 Terminal	70 x 100 x 112
PC35-A	Open type for terminal plugs ribbed sides	82 x 100 x 72
DB26-T	26 Terminal	110 x 155 x 110

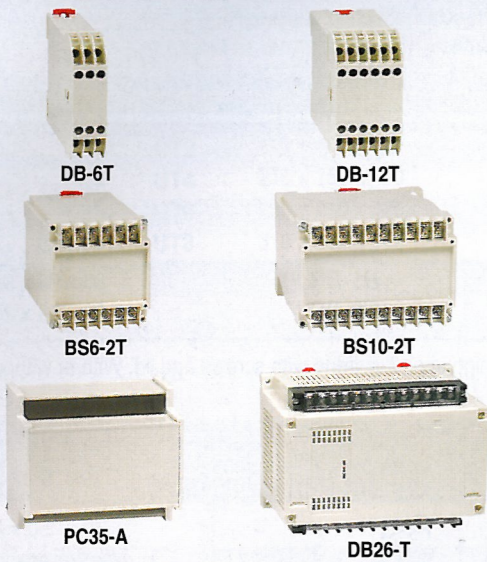

Base Mount Box IP65

Code	Description	Size W x L x D
F10-C	Clear Lid with terminal chamber	200 x 160 x 77
F10-G	Grey Lid with terminal chamber	200 x 160 x 77

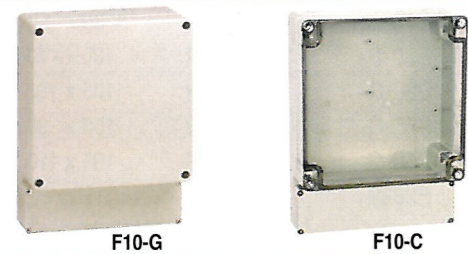

DIN Box RAL7035 Grey

Code	Description	Size W x H x D
04.4910000	10 terminal DIN Mount Box ABS UL94V-0 self extinguishing	55 x 70 x 110



Plug-in Case (Heidenreich)

62.1040021	12 Terminal Plug-in Box Base; ABS Blue Cover; Polystyrene self extinguishing Light Grey UL94V-0	52 x 113 x 106
------------	----------------------------------------------------------------------------------------------------	----------------

Instrument Housing ABS Grey

G968G-0	Complete with base, top, battery cover and 4 screws Display Area: 71.5 x 35mm	100 x 180 x 40
---------	----------------------------------------------------------------------------------	----------------

Universal DIN Supports

SDA	DIN Support	90 x 35mm
SDD	DIN Support	90 x 44mm
SDP	DIN Support	55.40 x 44mm

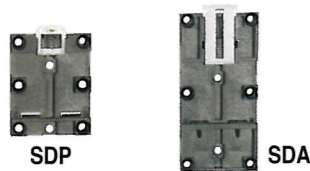

Desktop Instrument Housing ABS Grey

Grey ABS Front Plate	Transparent Red Front Plate	Standard Sizes W x D x H
● RM2055L-FT	● RM2055L-IR-FT	190 x 140 x 70
● RM2095S-FT	● RM2095S-IR-FT	250 x 180 x 50

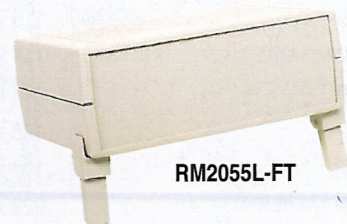

ELECTRONIC INSTRUMENTATION ENCLOSURES

Type MH68 terminals on top only

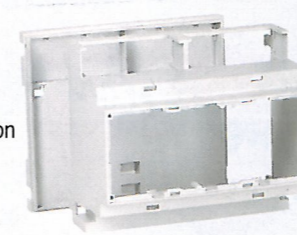

Type MDH68 with hinged cover and terminal top & bottom

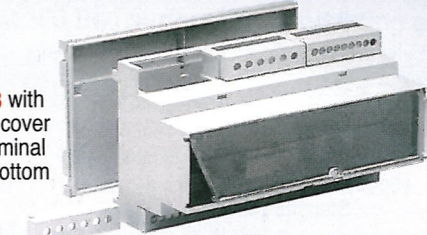

DIN Width:	1M	2M	3M	4M	6M		9M	
					Terminals Top only	Terminals Top&Bottom	Terminals Top only	Terminals Top&Bottom
Housing Type H53	1MH53	2MH53	3MH53	4MH53	6MH53	6MDH53	9MH53	9MDH53
Housing Type H68	1MH68	2MH68	3MH68	4MH68	6MH68	6MDH68	9MH68	9MDH68
Housing Type HC53	1MHC53	2MHC53	3MHC53	4MHC53	6MHC53	6MDHC53	9MHC53	9MDHC53
Top cover Grey	P05010201P	P05020201P	P05030201P	P05040201P	P05060201P		P05090201P	
Top cover Red transparent	P05010821P	P05020821P	P05030821P	P05040821P	P05060821P		P05090821P	
Top cover hinged transparent for H68 only	P05010721R	P05020721R	P05030721R	P05040721R	P05060721R		P05090721R	

Type H53 has no provision for hinged top cover. HC53 Solid Top

Terminal Covers

	3T with breakout plastic for terminals required only	For 5mm or 5.08mm pitch terminals	For 7.5mm pitch terminals	For 10mm pitch terminals	No holes (blank)	
Code	No of Holes	Code	No of Holes	Code	No of Holes	Code
1M	P05010203T 3	P05010201T 3	P05010204T 2	P05010202T 2	P05010206T	
2M	P05020203T 6	P05020201T 6	P05020204T 4	P05020202T 3	P05020206T	
3M	P05030203T 9	P05030201T 9	P05030204T 6	P05030202T 5	P05030206T	
4M	P05040203T 12	P05040201T 12	P05040204T 8	P05040202T 6	P05040206T	

For Terminal Blocks see Page 243. Special Terminal Covers can be made to order

Housing Dimensions

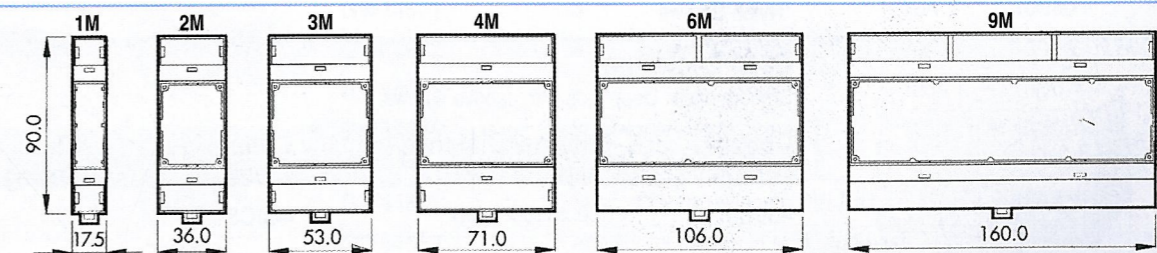

MODULBOX (DIN Mount)

- ① case
- ② base
- ③ fastening element
- ④ terminal cover*
- ⑤ panel*
- ⑥ panel with hook*
- ⑦ panel with hinges*
- ⑧ terminal*
- *accessories

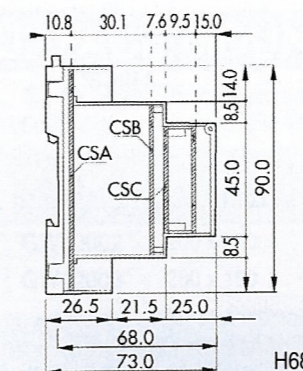
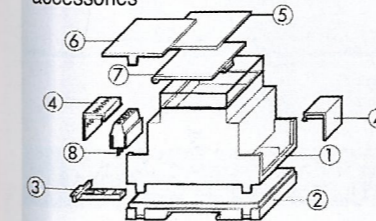

Top Plate for H53/H68

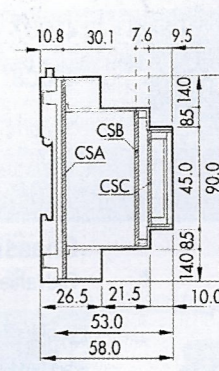

Material:
Self-extinguishing
Noryl UL94V-0
Grey RAL7035

Special colours on request

PC Board dimensions

	1M	2M	3M	4M	6M	9M
CSA	86.7x14.4	86.7x33.0	86.7x50.3	86.7x68.0	86.7x103.0	86.7x155.0
CSB	57.8x14.2	58.8x32.0	58.8x49.3	58.8x67.0	58.8x102.0	58.8x155.4
CSC	41.8x14.2	42.0x32.0	42.0x49.3	42.0x67.0	42.0x102.0	42.0x154.0

Thickness of printed circuit boards 1.6mm

Tolerance CSA - CSB - CSC: up to 86.7 = 0 ÷ -0.3; over 86.7 = ± 0.3

ECONOMIC PLASTIC SURFACE MOUNTING ENCLOSURES

- RAL 7032 Grey
- Flame Resistant. Self-extinguishing
- Temperature range -5° to + 60°C
- Shock resistant 6J

The Contractors choice!

Junction Boxes

- Stepped glands
- Press-on lids

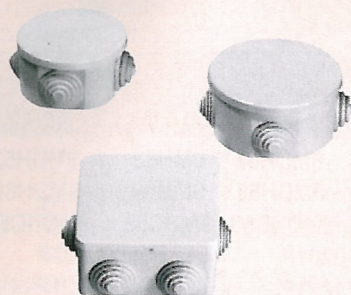

Code	External Dimensions (mm)	Entries No	Conduit Size Ø (mm)	IP Rating	Pack/ Carton Qty
400C1	Ø65 x 35D	4	20	IP44	5/120
400C2	Ø80 x 40D	4	20	IP44	5/150
400C3	80 x 80 x 40D	6	20	IP44	5/160

Standard Enclosures

Smooth side walls. Lids with captive screws.

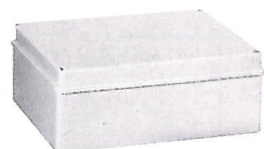

Code Grey Lid	External Dimensions (mm)	Code Clear Lid	IP Rating	Carton Qty
410C4	100 x 100 x 50D	-	IP56	100
410C4R	120 x 80 x 50D	-	IP56	100
410C5	150 x 110 x 70D	420C5	IP56	42
410C6	190 x 140 x 70D	420C6	IP56	24
410C7	240 x 190 x 90D	420C7	IP56	16
410C8*	300 x 220 x 120D	420C8*	IP56	6
410C9*	380 x 300 x 120D	420C9*	IP56	4

*Nylon Screws

Deep Enclosures

Smooth walls. Deep Lids with captive screws.

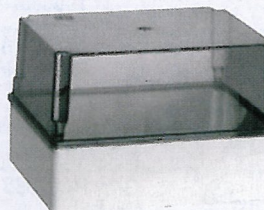
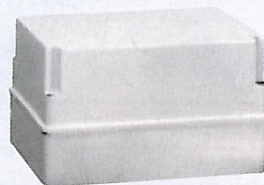

Code Grey Lid	External Dimensions (mm)	Code Clear Lid	IP Rating	Carton Qty
430C5	150 x 110 x 140D	440C5	IP56	18
430C6	190 x 140 x 140D	440C6	IP56	16
430C7	240 x 190 x 160D	440C7	IP56	8
430C8*	300 x 220 x 180D	440C8*	IP56	4

*Nylon Screws

Chassis Plates

Galvanised Steel.



Code	Enclosure Dimensions (mm)	Pack Qty
GX44614	150 x 110	30
450P6	190 x 140	30
450P7	240 x 190	30
450P8	300 x 220	20
450P9	380 x 300	20

EMERGENCY BREAK-GLASS STATIONS

IP55 RAL300 Red surface/flush mounting emergency enclosure



Code	Description	Size H x W x D	Carton Qty
GW42201	Break glass station with push button which can be lit. 1NO + 1NC	120 x 120 x 50	1/10
GW42211	Spare 'Safe Push' glass for GW42201		1/10
GW30943	Spare 230V lamp		
GW42204	With 22mm Ø hole and key lock	180 x 108 x 100	1/10
GW42213	Spare 'Safe Push' glass for GW42204		1/10
GW42203	With key lock galvanised metal chassis plate	180 x 180 x 100	1/10
GW42212	Spare 'Safe Push' glass		1/10
GW42216	Glass hammer with fixing support		1/10

TERMINAL BLOCKS

Terminal Blocks for mounting into standard enclosures Press on multi-pole grey RAL7035 - 450V



Code	No. of way	Cable Size	Max Load	Pack/ Carton Qty
GW44606	3 x	4mm ²	57A	10/100
GW44607	4 x	4mm ²	57A	10/100
GW44608	5 x	4mm ²	57A	10/100
GW44610	5 x	6mm ²	76A	10/100
GW44612	5 x	16mm ²	125A	10/100
GX44614	5 x	35mm ²	210A	1/10

Insulated Terminal Blocks - 450V

GW44671	3 x	6mm ²	76A	10/100
GW44672	5 x	6mm ²	76A	10/100
GW44673	4 x	16mm ²	125A	10/50
GW44674	[2 x 16mm ² / 3 x 6mm ²]	125A	10/50	
GW44681	Support for mounting on DIN Rail			100
GW44682	Adaptor for fixing into enclosure base			200

SURFACE MOUNTING ENCLOSURES

42 TV RANGE complete with Hinge. RAL 7035 Grey IP41 Surface-mounting adaptable enclosures with reversible door with smooth and honeycombed surface

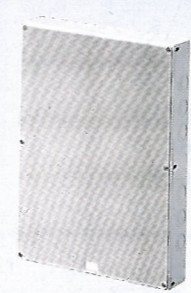

Code	Internal dimensions L x H (mm)	Depth D (mm)	No. Entries			Chassis Plates
			Ø 20.5	Ø 20.5/23	Ø 23/29	
GW42002	200 x 150	60	12	4	-	GW44615
GW42003	200 x 150	80	12	4	-	GW44615
GW42005	300 x 200	60	-	-	16	GW44616
GW42006	300 x 200	80	-	-	16	GW44616

Junction box for combination of modular enclosures and components - IP55

GW27402	132 x 82 x 55
GW26406	Watertight coupler 23mm

GW27402



WATERTIGHT ENCLOSURES

46 Range - Triangular key locks - Chassis Plates to be ordered separately

Polyester

- RAL 7035 Grey
- IP65

Stainless Steel

- Fingerprint proof satin finish
- IP55
- 304 Stainless



External Dimensions (mm) H x W x D	Code with plain door IP65	Code with perspex door	Code IP55	Chassis plates Steel	Inner door Polyester
300 x 250 x 160	GW46001	GW46201	-	GW46401	-
425 x 310 x 160	GW46002	GW46202	GW46052	GW46402	GW46414
500 x 405 x 200	GW46003	GW46203	-	GW46403	GW46415
650 x 405 x 200	GW46004	GW46204	GW46054	GW46404	GW46416
650 x 515 x 250	GW46005	GW46205	-	GW46405	GW46417
800 x 585 x 300	GW46006	GW46206	GW46056	GW46406	GW46418
1060 x 800 x 350	GW46007	GW46207	-	GW46407	GW46419

Typical applications

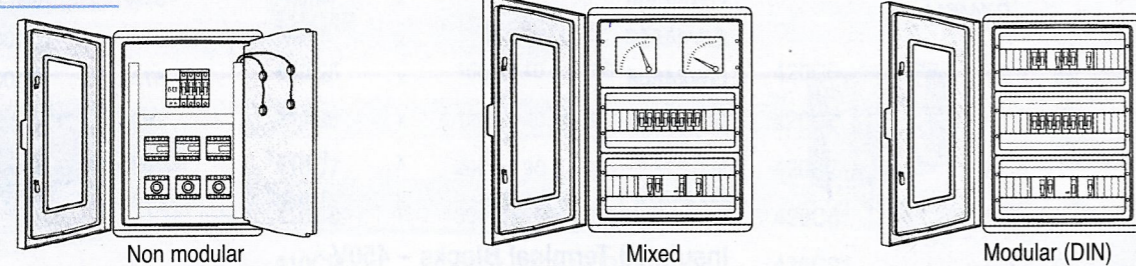

Steel brackets for surface fixing of 46 range enclosures

- GW46446 Set of 4 brackets
- GW-KEY Spare triangular key
- GW46445 Safety lock with handle and key

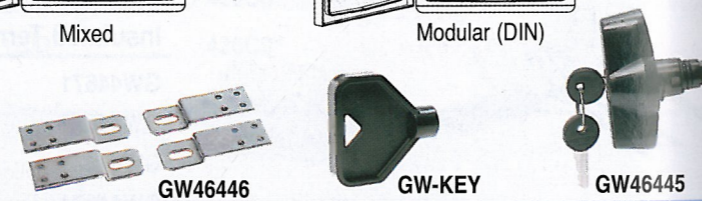

Modular accessories

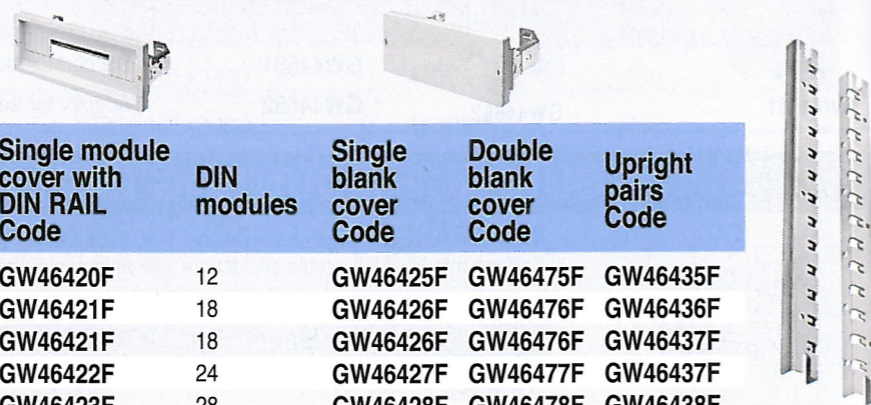

Enclosure	No. of single panels accepted	Max No. DIN modules	Single module cover with DIN RAIL Code	DIN modules	Single blank cover Code	Double blank cover Code	Upright pairs Code
GW46002/46202	3	36 (3 x 12)	GW46420F	12	GW46425F	GW46475F	GW46435F
GW46003/46203	3	54 (3 x 18)	GW46421F	18	GW46426F	GW46476F	GW46436F
GW46004/46204	4	72 (4 x 18)	GW46421F	18	GW46426F	GW46476F	GW46437F
GW46005/46205	4	96 (4 x 24)	GW46422F	24	GW46427F	GW46477F	GW46437F
GW46006/46206	5	140 (5 x 28)	GW46423F	28	GW46428F	GW46478F	GW46438F
GW46007/46207	5	180 (5 x 36)	GW46424F	36	GW46429F	GW46479F	GW46439F

44 Range - Moulded enclosure for electrical & electronic components IP55 120°C

Dimensions (mm)	Code Grey door	Code Transparent door	Steel Chassis Plate	Carton Qty
254 x 200 x 135	GW44808	GW44818	GW44636	12
316 x 236 x 135	GW44809	GW44819	GW44637	8
396 x 316 x 160	GW44810	GW44820	GW44638	4
474 x 396 x 160	GW44811	GW44821	GW44639	2

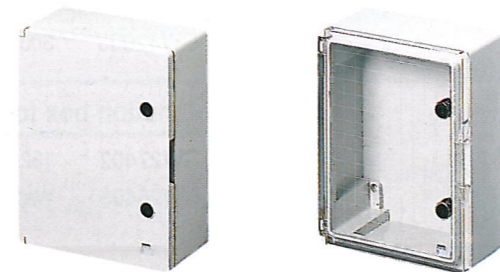

WATERTIGHT SURFACE MOUNTING PLASTIC ENCLOSURES

44CE Range RAL 7035 Grey



Code	Internal Dimensions (mm)	Entries No.	Gland hole Ø (mm)	Conduit Max Ø (mm)	Spare Lid Screw	Pack/ Carton Qty
75°C Junction Boxes with stepped glands and press-on lids - IP44						
GW44001	Ø 65 x 35	4	23	20	-	5/280
GW44002	Ø 80 x 40	4	23	20	-	5/135
GW44003	80 x 80 x 40	6	23	20	-	5/90

Junction Boxes with stepped glands. Lids with captive screws - IP55

GW44004	100 x 100 x 50	6	29	25	4 S/S screws	60
GW44005	120 x 80 x 50	6	29	25	4 S/S screws	66
GW44006	150 x 110 x 70	10	29	25	4 S/S screws	40
GW44007*	190 x 140 x 70	10	37	32	a	24
GW44008*	240 x 190 x 90	12	37	32	a	12
GW44009*	300 x 220 x 120	12	48	32	b	6

Enclosures with standard lid - IP56

Grey lid Code 75°C	Internal Dimensions (mm)	Spare Lid Screw	Pack/ Carton Qty	Clear lid Code 120°C
GW44204	100 x 100 x 50	4 S/S screws	105	-
GW44205	120 x 80 x 50	4 S/S screws	91	-
GW44206	150 x 110 x 70	4 S/S screws	50	GW44426
GW44207*	190 x 140 x 70	a	30	GW44427*
GW44208*	240 x 190 x 70	a	14	GW44428*
GW44209*	300 x 220 x 120	b	6	GW44429*
GW44210*	380 x 300 x 120	b	4	GW44430*
GW44211*	460 x 380 x 120	a	3	GW44431*

Enclosures with deep lid - IP56

Grey lid Code 75°C	Internal Dimensions (mm)	Spare Lid Screw	Pack/ Carton Qty	Clear lid Code 120°C
GW44214	100 x 100 x 120	4 S/S screws	45	-
GW44215	120 x 80 x 120	4 S/S screws	55	-
GW44216	150 x 110 x 140	4 S/S screws	24	GW44436
GW44217*	190 x 140 x 140	a	16	GW44437*
GW44218*	240 x 190 x 160	a	12	GW44438*
GW44219*	300 x 220 x 180	b	7	GW44439*
GW44220*	380 x 300 x 180	b	3	GW44440*
GW44221*	460 x 380 x 180	b	2	GW44441*

* Sealable enclosure with hinged plastic screw-on lid

Galvanized metal chassis plates

GX44614	150 x 110	
GX44615	190 x 140	
GX44616	240 x 190	
GX44617	300 x 220	
GX44618	380 x 300	
GX44619	460 x 380	
		Insulated chassis plates
		GW44625
		GW44626
		GW44627
		GW44628
		GW44629

Accessories

GW44621	Wall mounting brackets, for enclosures 190 x 140 and larger size boxes	
GW44620	Watertight coupler 47mm I.D.	10/160
GW50428	Stepped glands (for 20mm hole)	100/1000
GW50429	Stepped glands (for 23mm hole)	100/1000
GW50430	Stepped glands (for 29mm hole)	100/1000
GW50431	Stepped glands (for 37mm hole)	50/500
GW50432	Stepped glands (for 48mm hole)	35/350
GW52401	HSS steel multi dia. milling cutter for plastic boxes	1/4
AS01092	Spare Nylon 10mm screw for enclosures 'a'	
AS01093	Spare Nylon 12mm screw for enclosures 'b'	
58110313	S/S Screws for GW44204/5/14/15	
58110305	S/S Screws for GW44206 and GW44216	



CONDUIT ACCESSORIES

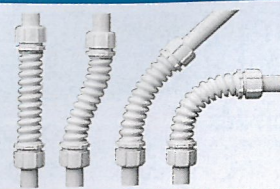

50 Speedy - Flex Range - RAL 7035 Grey watertight flexible couplings

IP66 Code	For rigid conduits with external Ø mm	External Ø mm	Internal Ø mm	Coupling length mm	IP44 Code
GW50202	20	31.5	17	160	GW50208
GW50203	25	41	21.5	205	GW50209

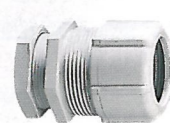

IP66



IP44

Couplings (Flexible conduit to enclosure) (Flexible to rigid conduit)

IP66 Code	Conduit External Ø mm	Mounting hole Ø mm	IP44 Code	Code	Conduit External Ø mm
GW50415	16	20	GW50421	DX43420	20
GW50416	20	23	GW50422	DX43425	25
GW50417	25	29	GW50424	DX43432	32
GW50418	32	37	-	DX43440	40
GW50419	40	48	-	-	-



Flexible conduit shown fitted

Flexible Self-Extinguishing Conduit IP66 *Low Halogen +5 - 90°C

Size	Code (White) PVC	Code (Black) PVC	Code (Grey) Polypropylene*	Length
Rolls				
16mm	DX16216/100	DX15016/100	DX20016/100	/100m
20mm	DX16220/100	DX15020/100	DX20020/100	/100m
25mm	DX16225/50	DX15025/50	DX20025/50	/50m
32mm	DX16232/25	DX15032/25	DX20032/25	/25m
40mm	DX16240/25	DX15040/25	DX20040/25	/25m

Flexible Self-Extinguishing Conduit IP66 with Draw Wire

Size	Code (White) PVC	Code (Black) PVC	Code (Grey) Polypropylene*	Length
16mm	DX16316/100	DX15116/100	-	/100m
20mm	DX16320/100	DX15120/100	-	/100m
25mm	DX16325/50	DX15125/50	-	/50m
32mm	DX16332/25	DX15132/25	-	/25m
40mm	DX16340/25	DX15140/25	-	/25m
50mm	DX16350/25	DX15150/25	-	/25m

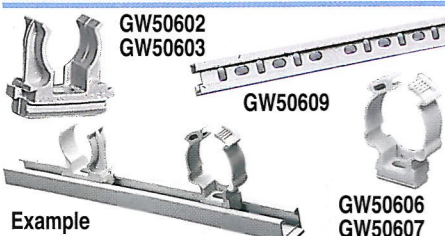

Example

Saddle Clamps (Shock-resistant polymer)

GW50602	20mm	clamp
GW50603	25mm	clamp
GW50606	20mm	clamp
GW50607	25mm	clamp
GW50609	200mm long	rail

Flexible Joint (for Flexible Conduit)

Code	Size
GFLEX16	16mm
GFLEX20	20mm
GFLEX25	25mm

Diflex Range Spiralled Sheath. Heavy duty. Temp. +5°C to 60°C

Sheath Ø mm	Black PVC		Grey PVC	
	Coupling	Sheath	Coupling	Sheath
8	DX54108	DX30108/30	DX54008	DX30008/30
10	DX54110	DX30110/30	DX54010	DX30010/30
12	DX54112	DX30112/30	DX54012	DX30012/30
16	DX54116	DX30116/30	DX54016	DX30016/30
20	DX54120	DX30120/30	DX54020	DX30020/30
25	DX54125	DX30125/30	DX54025	DX30025/30
50	DX54150	DX30150/30	-	-

Packed in 30m coil

PG Glands IP66 (Compression glands) c/w lock nut

Code	PG Size	Mounting Hole Ø	Cable Ø	Pack Qty
GW52001	7	12.5mm	3-6mm	50
GW52002	9	16mm	5-8mm	50
GW52003	11	19mm	7-10.5mm	25
GW52004	13.5	20mm	9-12.5mm	25
GW52005	16	23mm	13-16mm	25
GW52006	21	29mm	17-20mm	25
GW52007	29	37mm	21-26mm	25
GW52008	36	48mm	30-34mm	10
GW52009	42	54mm	40-43mm	6
GW52010	48	60mm	46-50mm	5



RCC Cert. No. 0903186

DISTRIBUTION BOARDS – SURFACE MOUNTING

IP55

Grey surface mounting modular enclosures with transparent door

(Terminal blocks to be ordered separately)



GW40001



GW40004
GW40005



GW40008
GW40009

IP55 Code	Size H x W x D	Ctn Qty	Type	IP40 Code	Size H x W x D	Ctn Qty
GW40001	170 x 105 x 98	24	4 Module - (1 x 4) No provision for terminal blocks	-	-	-
GW40003	180 x 180 x 98	24	8 Module - (1 x 8) Accepts 1 terminal block code GW40401	GW40043	180 x 200 x 100	14
GW40004	250 x 250 x 135	6	12 Module with T/B GW40402	-	-	-
GW40005	250 x 250 x 135	8	12 Module - (1 x 12) Accepts 1 terminal block code GW40402	GW40045	225 x 280 x 100	9
GW40006	375 x 250 x 135	6	24 Module with T/B 2 x GW40401	-	-	-
GW40007	375 x 250 x 135	6	24 Module - (2 x 12) Accepts 2 terminal blocks code GW40401	GW40047	350 x 280 x 100	6
GW40008	400 x 376 x 135	4	36 Module with T/B 2 x GW40402	-	-	-
GW40009	400 x 376 x 135	4	36 Module - (2 x 18) Accepts 2 terminal blocks code GW40402	GW40049	400 x 400 x 130	2
-	-	2	54 Module - (3 x 18) Accepts 2 terminal blocks code GW40402	GW40051	550 x 400 x 130	2
-	-	1	72 Module - (4 x 18) Accepts 4 terminal blocks code GW40402	GW40053	850 x 400 x 150	1

IP40



GW40043

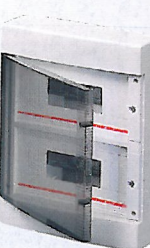

GW40045

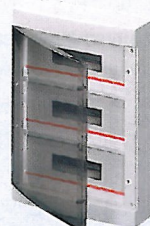

GW40047



GW40051

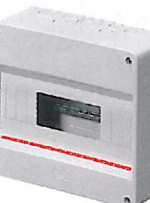

GW40053

Grey surface mounting modular enclosures

No door Code IP40	Type	Size H x W x D	Carton Qty
GW40022	2 Module - (1 x 2)	130 x 45 x 85	84
GW40023	4 Module - (1 x 4)	130 x 90 x 85	36
GW40024	6 Module - (1 x 6)	155 x 140 x 85	34
-	No provision for terminal block	-	-
GW40026	8 Module - (1 x 8) Accepts 1 terminal block code GW40401	180 x 180 x 95	24
GW40028	12 Module - (1 x 12) Accepts 1 terminal block code GW40402	215 x 250 x 95	12
GW40030	24 Module - (2 x 12) Accepts 2x terminal blocks code GW40401	340 x 250 x 95	12
GW40032	36 Module - (3 x 12) Accepts 2x terminal blocks code GW40402	465 x 250 x 95	9



GW40022

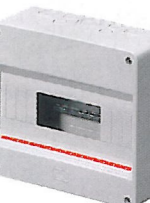

GW40023

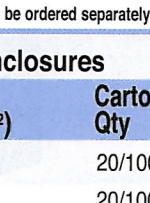

GW40024

GW40028

Grey Surface Mount Enclosures c/w Terminal Block

Code IP40	Type	Size H x W x D	Carton Qty
GW40501	13 Module	225 x 250 x 93.5	8
GW40502	26 Module (2 x 13)	350 x 250 x 93.5	4
GW40503	39 Module (3 x 13)	475 x 250 x 93.5	3



NEW



NEW

Grey Surface Mount Enclosures c/w Terminal Block

Code IP40	Type	Size H x W x D	Carton Qty
GW40501	13 Module	225 x 250 x 93.5	8
GW40502	26 Module (2 x 13)	350 x 250 x 93.5	4
GW40503	39 Module (3 x 13)	475 x 250 x 93.5	3

Insulated terminal blocks for surface and flush mounting modular enclosures

Code	Neutral Terminal Block (No. Poles x sect. mm ²)	Earth Terminal Block (No. Poles x sect. mm ²)	Carton Qty
GW40401	(1 x 25) + (7 x 10)	(1 x 25) + (7 x 10)	20/100
GW40402	(3 x 25) + (10 x 10)	(3 x 25) + (10 x 10)	20/100
GW40404	(5 x 25) + (14 x 10)	(5 x 25) + (14 x 10)	20/100
GW40423	DIN Blanks, 17.5mm wide, 4 ¹ / ₂ Modules per strip		100
55010961	Spare Screws for GW40001/3/4/5/6/7/8/9		



GW40401



GW40402

GW40423

55010961

DISTRIBUTION BOARDS

Flush Mount DB with steel frame and door – colour White RAL 9016 IP40

Code	DB Ext. Size H x W x D	Tray Size H x W x D	Type
GW40151	338 x 335 x 75	303 x 300 x 85	Module - 12 (1 x 12) c/w Neutral and Earth Bar
GW40152	463 x 335 x 75	428 x 300 x 85	Module - 24 (2 x 12) c/w Neutral and Earth Bar
GW40153	585 x 335 x 75	553 x 300 x 85	Module - 36 (3 x 12) c/w Neutral and Earth Bar
GW40154	713 x 335 x 75	678 x 300 x 85	Module - 48 (4 x 12) c/w Neutral and Earth Bar

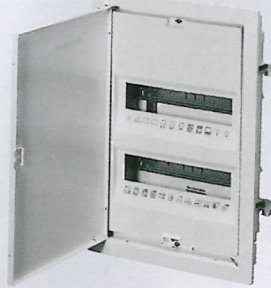

160A Flush Mount steel DB IP40 – 47CVX range – colour Grey RAL 7035

• Complete with Galvanized Wall Tray

Glass Door Code	Solid Steel Door Code	DIN Modules	DB Ext. Size H x W x D x + Glass	Tray Size H x W x D
GW47082	GW47087	96 (4 x 24)	706 x 730 x 34 x 30mm	600 x 600 x 105
GW47083	GW47088	120 (5 x 24)	906 x 730 x 34 x 30mm	800 x 600 x 105
GW47084	GW47089	144 (6 x 24)	1106 x 730 x 34 x 30mm	1000 x 600 x 105



Curved tempered glass door

Accessories

- GW47174 Solid front panel 150(H) x 600(W) mm c/w 2 hinges
- GW47193 Earth bar kit 20 x 5 (24 holes x M6)
- GW47251 DIN (35mm) Rail Kit

For neutral bars see page 114 & 369.



160A Surface Wall Mount DB IP40 – colour Grey RAL 7035

• 47CVX 160 range • Equipped with 2 locks
• c/w 4 mounting brackets & 4 gland plates (top, bottom & sides)

Curved Tempered Glass Door DB Code	Solid Steel Door DB Code	(1) No Of Modules 150mm(H)	(2) No Of Modules 200mm(H)	DB Ext. Size H x W x D x + Glass
GW47011E	GW47021E	96 (4 x 24)	72 (3 x 24)	600 x 600 x 170 x 30mm
GW47012E	GW47022E	120 (5 x 24)	96 (4 x 24)	800 x 600 x 170 x 30mm
GW47013E	GW47023E	144 (6 x 24)	120 (5 x 24)	1000 x 600 x 170 x 30mm
GW47014E	GW47024E	192 (8 x 24)	144 (6 x 24)	1200 x 600 x 170 x 30mm

(1) & (2) DIN Panels 150 & 200(H)mm to be ordered separately

Accessories

- (1)GW47171 150mm(H) 24 DIN Kit c/w hinges and adjustable DIN Rail
- (2)GW47172 200mm(H) 24 DIN Kit c/w hinges and adjustable DIN Rail
- GW47174 Solid front panel 150(H) x 600(W) mm c/w 2 hinges
- GW47175 Solid front panel 200(H) x 600(W) mm c/w 2 hinges
- GW47176 200mm(H) panel with 4 x 72mm² cut outs and 1 x 9.5mm ø hole, c/w 2 hinges
- GW47193 Pre Drilled earth bar kit 20 x 5mm (24 holes x M6)

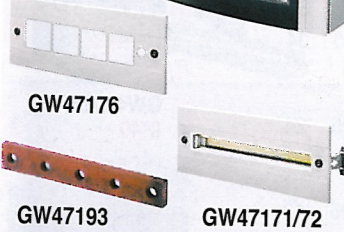

250A Surface Wall Mount Steel DB IP55 – colour Grey RAL 7035

• 47CVX 250 range • Equipped with 2 locks
• c/w 4 mounting brackets & 4 gland plates (top, bottom & sides)

Curved Tempered Glass Door DB Code	(1) No Of Modules 150mm(H)	(2) No Of Modules 200mm(H)	DB Ext. Size H x W x D x + Glass
GW47035	144 (6 x 24)	120 (5 x 24)	1000 x 600 x 254 x 30mm
GW47036	192 (8 x 24)	144 (6 x 24)	1200 x 600 x 254 x 30mm

(1) & (2) DIN Panels 150 & 200(H)mm to be ordered separately

Accessories

- (1)GW45201 150mm(H) 24 DIN Kit c/w hinges and adjustable DIN Rail
- (2)GW45202 200mm(H) 24 DIN Kit c/w hinges and adjustable DIN Rail
- GW47512 Solid front panel 150(H) x 600(W) mm c/w 2 hinges
- GW47513 Solid front panel 200(H) x 600(W) mm c/w 2 hinges
- GW47533 200mm(H) panel with 4 x 72mm² cut outs and 1 x 9.5mm ø hole, c/w 2 hinges
- GW47193 Pre Drilled earth bar kit 20 x 5mm (24 holes x M6)



DISTRIBUTION BOARDS – FLUSH MOUNTING

Domestic Type D/B



White

Toner Black

Order CBs separately

Protected flush mounting modular enclosure - IP40 (Terminal blocks to be ordered separately)
Transparent Smoked Door

Code	Size H x W x D	Type	Carton Qty
GW40237*	160 x 130 x 85	4 Module - (1 x 4) No provision for terminal block	12
GW40225*	185 x 230 x 72.5	8 Module - (1 x 8) Accepts 1 terminal block code GW40401	16
GW40229*	190 x 310 x 72.5	12 Module - (1 x 12) Accepts 1 terminal block code GW40402	12
GW40233*	330 x 310 x 80	24 Module - (2 x 12) Accepts 2 terminal blocks code GW40401	5
GW40239*	483 x 310 x 90	36 Module - (3 x 12) Accepts 2 terminal blocks code GW40402	5

*Add colour to code: TB (Milk White), TN (Toner Black), VT (Titanium), VA (Slate Grey)

IP40 DB colour co-ordinated with Chorus System Range Plates
Door with Automatic Opening

Code	Size H x W x D	Type	Colour	Carton Qty
GW40981TB	255 x 320 x 80	12 Module - (1 x 12)	White	2
GW40981VT	255 x 320 x 80	12 Module - (1 x 12)	Metallic Titanium	2
GW40981VA	255 x 320 x 80	12 Module - (1 x 12)	Metallic Slate	2
GW40991TB	360 x 320 x 80	24 Module - (2 x 12)	White	2
GW40991VT	360 x 320 x 80	24 Module - (2 x 12)	Metallic Titanium	2
GW40991VA	360 x 320 x 80	24 Module - (2 x 12)	Metallic Slate	2



NEW STYLE DISTRIBUTION BOARDS CDK RANGE

DB with transparent smoked door (Terminal blocks to be ordered separately)

IP65 Grey Surface Mount	Size H x W x D	Ctn Qty	Type	IP40 White Flush Mount	Size H x W x D	Ctn Qty
GW40101	210 x 143 x 100	19	4 Module - (1 x 4) No provision for terminal blocks	-	-	-
-	-	-	6 Module - (1 x 6) No provision for terminal blocks	GW40603	170 x 200 x 85	21
GW40102	210 x 215 x 100	12	8 Module - (1 x 8) Accepts 1 terminal block code GW40401	GW40604	195 x 240 x 85	12
GW40103	260 x 298 x 140	6	12 Module - (1 x 12) Accepts 1 terminal block code GW40402	GW40605	270 x 330 x 85	8
GW40106	285 x 410 x 140	3	18 Module - (1 x 18) Accepts 1 terminal block code GW40404	GW40608	310 x 465 x 85	4
GW40104	420 x 298 x 140	3	24 Module - (2 x 12) Accepts 1 terminal block code GW40402	GW40606	420 x 330 x 85	6
GW40107	463 x 410 x 140	2	36 Module - (2 x 18) Accepts 2 terminal blocks code GW40404	GW40609	505 x 465 x 85	3
GW40108	655 x 410 x 140	1	54 Module - (3 x 18) Accepts 2 terminal blocks code GW40404	GW40610	680 x 465 x 95	2
GW40109	878 x 410 x 140	1	72 Module - (4 x 18) Accepts 2 terminal blocks code GW40404	GW40611	855 x 465 x 95	1

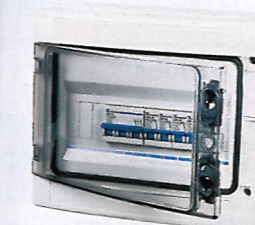

Grey Surface mounting IP65 (Circuit breakers excluded)

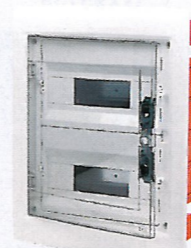

White Flush mount IP40

Cylindrical security/safety lock

GW40422 Die-cast metal

Locks are supplied with 2 keys with standardised code, suitable for CDK Range

DISTRIBUTION BOARDS – SURFACE & FLOOR MOUNT

630A Surface Mount DB Board IP43 47 CVX Range – Colour Grey RAL 7035

• Complete with Functional Frames & Cable Gland Plates

Structures Code	Sides Code	Curved Glass Door Code	Solid Door Code	(1) No Of Modules 150mm(H)	(2) No Of Modules 200mm(H)	DB Ext Size H x W x D
GW45004	GW45024	GW45104	GW45124	144 MOD (24 x 6)	120 MOD (24 x 5)	1000 x 600 x 230
GW45005	GW45025	GW45105	GW45125	192 MOD (24 x 8)	144 MOD (24 x 6)	1200 x 600 x 230
GW45014	GW45024	GW45114	GW45134	216 MOD (36 x 6)	180 MOD (36 x 5)	1000 x 850 x 230
GW45015	GW45025	GW45115	GW45135	288 MOD (36 x 8)	216 MOD (36 x 6)	1200 x 850 x 230

GW45004/5/14/15

(1) & (2) DIN Modules 150mm & 200mm (H) to be ordered separately.

Accessories for Surface Mount and Floor Mount Panels

Code	Description
GW45201	150 mm (H) 24 DIN Kit c/w Hinges and DIN Rail
GW45206	150 mm (H) 36 DIN Kit c/w Hinges and DIN Rail
GW45202	200 mm (H) 24 DIN Kit c/w Hinges and DIN Rail
GW45207	200 mm (H) 36 DIN Kit c/w Hinges and DIN Rail
GW45303	150 mm (H) x 600mm (L) Solid Front Panel c/w Fixi Hinges
GW45323	150 mm (H) x 850mm (L) Solid Front Panel c/w Fixi Hinges
GW45304	200 mm (H) x 600mm (L) Solid Front Panel c/w Fixi Hinges
GW45324	200 mm (H) x 850mm (L) Solid Front Panel c/w Fixi Hinges
GW45374	600 x 200mm (H) Panel with 4 x 96mm ² cut outs, 1 x 9,5mm ø hole c/w Hinges
GW45379	850 x 200mm (H) Panel with 4 x 96mm ² cut outs, 1 x 9,5mm ø hole c/w Hinges
GW45534	Pre-drilled Earth Bar Kit 600 x 20 x 5 (24 Holes M6)
GW45535	Pre-drilled Earth Bar Kit 850 x 20 x 5 (36 Holes M6)

GW45024/25

GW45104/05/14/15

630A Floor Mount DB Board IP43 47 CVX Range – Colour Grey RAL 7035

• Complete with Functional Frames, Cable Gland Plates and Controllable Base H=100mm Blue RAL 5003

Structures Code	Sides Code	Curved Glass Door Code	Solid Door Code	(1) No Of Modules 150mm(H)	(2) No Of Modules 200mm(H)	DB Ext Size H x W x D
GW45007	GW45027	GW45107	GW45127	240 MOD (24 x 10)	192 MOD (24 x 8)	1600 x 600 x 230
GW45009	GW45029	GW45109	GW45129	312 MOD (24 x 13)	240 MOD (24 x 10)	2000 x 600 x 230
GW45017	GW45027	GW45117	GW45137	360 MOD (36 x 10)	288 MOD (36 x 8)	1600 x 850 x 230
GW45019	GW45029	GW45119	GW45139	468 MOD (36 x 13)	360 MOD (36 x 10)	2000 x 850 x 230

(1) & (2) DIN Modules 150mm & 200mm (H) to be ordered separately.

630A Surface & Floor Mount DB Boards complete with Top, Bottom, Doors & Sides

• Accessories to be ordered separately

No Of Modules	Surface Mount c/w Curved Glass Door Code	Surface Mount c/w Solid Steel Door Code	Floor Mount c/w Curved Glass Door Code	Floor Mount c/w Solid Steel Door Code
*190-240	GX95104	GX95124	GX95107	GX95127
*240-312	GX95105	GX95125	GX95109	GX95129
*288-340	GX95114	GX95134	GX95117	GX95137
*360-468	GX95115	GX95135	GX95119	GX95139

GW45107/09/17/19



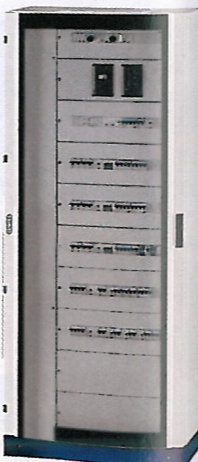
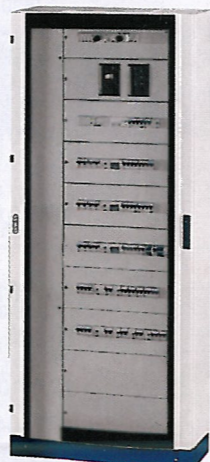
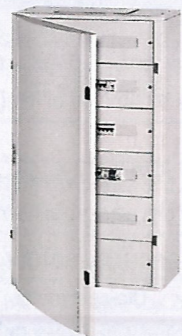
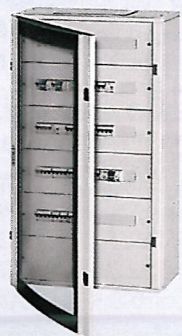

* Depending on which height 150mm or 200mm Module GX part no's assembled in S.A.

NEW



INTERNATIONAL PLUGS & SOCKETS

RCC Cert. 0806073

Italian Standard			Box/Ctn Qty
	GW28205	2P + E 16A socket	25/200
	GW28005	2P + E 16A plug	25/300
German/French Standard			Box/Ctn Qty
	GW28011	2P + E 16A plug	25/300
Italian/German Adaptor			Box/Ctn Qty
	GW28410	2P + E 10A plug to 16A socket	15/150





INDUSTRIAL SOCKETS

Code	Amps	Poles	Voltage
Industrial surface mounting IP44			
GW26222	16A	2P + E	230V
GW26223	16A	3P + E	400V
2 x 4 Flush mount IP44			
GW26420	16A	2P + E	230V
GW26421	16A	3P + E	400V

APPLIANCE INLET ACCESSORIES

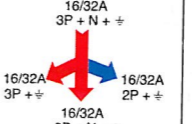
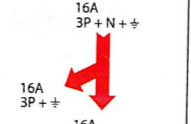
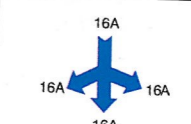
Code	Amps	Poles
Watertight caps for appliance inlets IP67		
For appliance inlet type		
GW60263	16A	2P + E
GW60264	16A	3P + E
GW60265	16A	3P + N + E
GW60266	32A	2P+E & 3P+E
GW60267	32A	3P + N + E

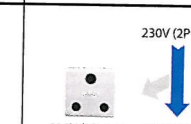
MULTIPLE-OUTLET SOCKETS & ADAPTORS

RATED CURRENT (A)	INPUT PLUG	IP67		IP67		IP40		IP40	
		Code	Code	Code	Code	Code	Code		
16	2P + ⚡	GW64024	-	GW64010	GW64052	GW64206	GW64223		
	3P + ⚡	GW64027	-	GW64013	GW64055	-	-		
	3P + N + ⚡	GW64028	GW64060	GW64014	GW64056	GW64207	GW64228		
32	3P + ⚡	GW64068	-	-	-	-	-		
	3P + N + ⚡	-	GW64061	-	-	-	-		
Output Sockets configuration									

INDUSTRIAL PLUGS, SOCKETS & SOCKET OUTLETS

IEC 309 low voltage 16A to 125A industrial plugs and sockets

Key Operated plug/socket outlet attachment

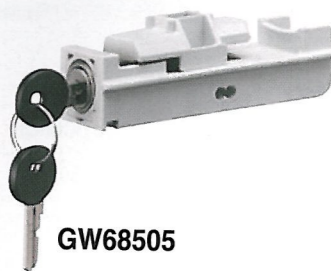

GW68505



RATED CURRENT (A)	POLES	RATED VOLTAGE (V)	REFERENCE	PLUGS		90° ANGLED PLUGS		90° ANGLED SURFACE MOUNTING APPLIANCE INLETS		CONNECTORS
				IP44	IP67	IP44	IP67	IP44	IP67	IP44
16	2P + ⊕	110 100 - 130	4	GW60001	GW60023	GW60082	GW60105	GW60401	GW60423	GW62001
	3P + ⊕		4	GW60002	GW60024					GW62002
	3P + N + ⊕	200 - 250	4		GW60025					
	2P + ⊕		6	GW60004	GW60026	GW60085	GW60108	GW60404	GW60426	GW62004
	3P + ⊕		9			GW60087			GW60428	
	3P + ⊕	400 380 - 415	6	GW60008	GW60030	GW60089	GW60112	GW60405		
	3P + N + ⊕		6	GW60009	GW60031	GW60090	GW60113	GW60408	GW60430	GW62008
	3P + ⊕	500 480 - 500	7	GW60010	GW60032	GW60091	GW60114	GW60409	GW60431	GW62009
	3P + N + ⊕		7	GW60011	GW60033	GW60092	GW60115	GW60410	GW60432	GW62010
	32	2P + ⊕	110 100 - 130	4	GW60012	GW60034	GW60093	GW60116	GW60411	GW60433
3P + ⊕		4		GW60013	GW60035	GW60093	GW60116	GW60412	GW60434	GW62012
2P + ⊕		200 - 250	6	GW60015	GW60037	GW60096	GW60119	GW60415	GW60437	GW62015
3P + ⊕			6							
3P + ⊕		400 380 - 415	6	GW60019	GW60041	GW60101	GW60123	GW60419	GW60441	GW62019
3P + N + ⊕			6	GW60020	GW60042	GW60102	GW60124	GW60420	GW60442	GW62020
3P + ⊕		500 480 - 500	7	GW60021	GW60043	GW60103	GW60125	GW60421	GW60443	GW62021
3P + N + ⊕			7	GW60022	GW60044	GW60104	GW60126	GW60422	GW60444	GW62022
3P + ⊕		380 - 440	3		GW60145		GW60146		GW60482	
63		2P + ⊕	110 100 - 130	9		GW61045				GW61445
	3P + ⊕	9			GW61046				GW61446	
	3P + ⊕	400 380 - 415	6		GW61052				GW61452	
	3P + N + ⊕		6		GW61053				GW61453	
	3P + ⊕	500 480 - 500	7		GW61054				GW61454	
	3P + N + ⊕		7		GW61055				GW61455	
125	3P + ⊕	400 380 - 415	6		GW60060				GW60460	
	3P + N + ⊕		6		GW60061				GW60461	
	3P + ⊕	500 480 - 500	7		GW60062				GW60462	
	3P + N + ⊕		7		GW60063				GW60463	

IEC 309 extra low voltage industrial plugs and sockets

16	2P	24 (20-25)	w.r.	GW60064		GW60127		GW60464	GW62064
	3P		w.r.	GW60065		GW60128		GW60465	GW62065
	3P	42(40-50)	12	GW60067					
32	2P	24 (20-25)	w.r.	GW60073		GW60136		GW60473	GW62073
	3P		w.r.	GW60074		GW60137		GW60474	GW62074

INDUSTRIAL PLUGS, SOCKETS & SOCKET OUTLETS

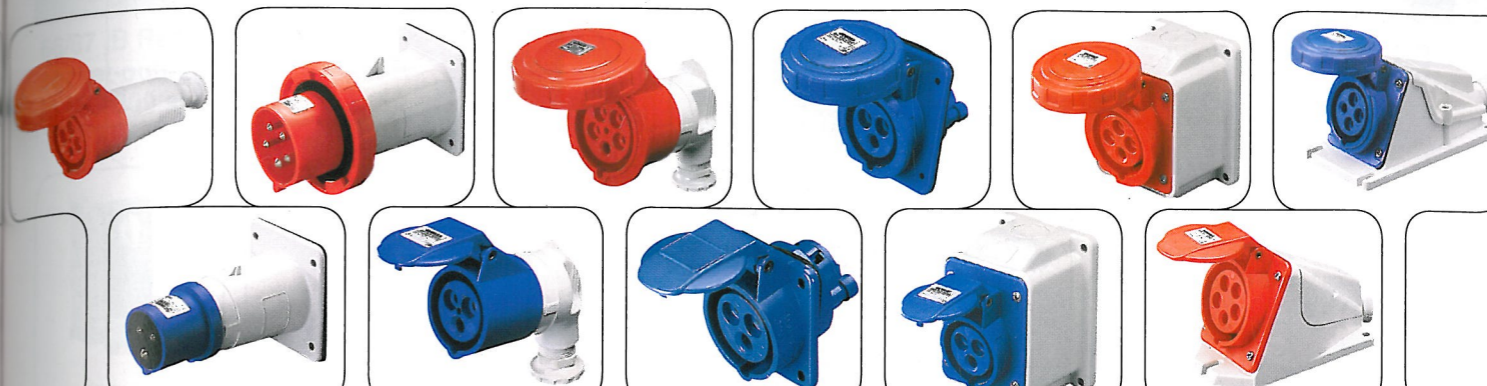

CONNECTORS	SURFACE MOUNTING APPLIANCE INLETS	SURFACE MOUNTING APPLIANCE INLETS	90° ANGLED CONNECTOR	90° ANGLED CONNECTOR	10° ANGLED FLUSH MOUNTING SOCKET-OUTLETS	10° ANGLED FLUSH MOUNTING SOCKET-OUTLETS	10° ANGLED SURFACE MOUNTING SOCKET-OUTLETS	10° ANGLED SURFACE MOUNTING SOCKET-OUTLETS	90° ANGLED SURFACE MOUNTING SOCKET-OUTLETS	90° ANGLED SURFACE MOUNTING SOCKET-OUTLETS
IP67	IP44	IP67	IP44	IP67	IP44	IP67	IP44	IP67	IP44	IP67
GW62023	GW62021	GW62023	GW62082	GW62105	GW62201	GW62224	GW62401	GW62423	GW62474	GW62496
GW62024					GW62202	GW62225			GW62475	GW62497
GW62026	GW62024	GW62026	GW62085	GW62108	*GW62205	GW62227	GW62404	GW62426	GW62477	GW62499
GW62028							GW62406			
					GW62206		GW62405			
GW62030	GW62028	GW62030	GW62089	GW62112	GW62209	GW62231	GW62408	GW62430	GW62481	GW62504
GW62031	GW62029	GW62031	GW62090	GW62113	GW62210	GW62232	GW62409	GW62431	GW62482	GW62505
GW62032	GW620210	GW62032	GW62091	GW62114	GW62211	GW62233	GW62410	GW62432	GW62483	GW62506
GW62033	GW620211	GW62033	GW62092	GW62115	GW62212	GW62234	GW62411	GW62433	GW62484	GW62507
GW62034	GW620212	GW62034	GW62093	GW62116	GW62213	GW62235	GW62412	GW62434	GW62485	GW62508
GW62035					GW62214	GW62236			GW62486	GW62509
GW62037	GW620215	GW62037	GW62096	GW62119	GW62216	GW62238	GW62415	GW62437	GW62488	GW62511
GW62038										
GW62041	GW620219	GW62041	GW62101	GW62123	GW62220	GW62242	GW62419	GW62441	GW62492	GW62515
GW62042	GW620220	GW62042	GW62102	GW62124	GW62221	GW62243	GW62420	GW62442	GW62493	GW62516
GW62043	GW620221	GW62043	GW62103	GW62125	GW62222	GW62244	GW62421	GW62443	GW62494	GW62517
GW62044	GW620222	GW62044	GW62104	GW62126	GW62223	GW62245	GW62422	GW62444	GW62495	GW62518
GW62128				GW62127		GW62283			GW62556	GW62557
GW63045									GW63445	
GW63046									GW63446	
GW63052										GW63526
GW63053						GW63253		GW63452		GW63527
GW63054						GW63254		GW63453		GW63528
GW63055						GW63255		GW63454		GW63529
GW62060						GW63256		GW63455		GW62534
GW62061						GW62261				GW62535
GW62062						GW62262				GW62536
GW62063						GW62263				GW62537
						GW62264				GW62538
										GW62539
										GW62547
										GW62548

*For small flange GW62204 (62 x 62mm)

INDUSTRIAL PLUGS, SOCKETS & SOCKET OUTLETS

IEC 309 16A to 125A

Padlockable in OFF position

NOTE 1:
New range of IP67 vertically interlocked socket outlets now available with built-in miniature circuit breaker, 6kA, C-Curve.



HORIZONTAL INTERLOCKED SURFACE MOUNTING SOCKET-OUTLETS
 VERTICAL INTERLOCKED SURFACE MOUNTING SOCKET-OUTLETS
 VERTICAL INTERLOCKED SURFACE MOUNTING SOCKET-OUTLETS
 VERTICAL INTERLOCKED SURFACE MOUNTING SOCKET-OUTLETS WITH BUILT IN MCB
 VERTICAL INTERLOCKED SOCKET-OUTLETS WITH NO BASE (LID ONLY)
 VERTICAL INTERLOCKED SURFACE MOUNTING SOCKET-OUTLETS FOR DIN CB/RCD
 VERTICAL INTERLOCKED SURFACE MOUNTING SOCKET OUTLETS

RATED CURRENT (A)	POLES	RATED VOLTAGE (V)	REFERENCE	IP44	IP55	IP67	IP67	IP55	IP66	IP66
16	3P + \perp	110 100 - 130	4	GW66002	-	GW66202N	GW66052N	-	-	-
	2P + \perp	230 200 - 250	6	GW66004	GW66204	GW66204N	GW66054N	GW66304	-	-
	3P + \perp	400	6	GW66008	GW66208	GW66208N	GW66058N	-	GW66981	GW66508
	3P + N + \perp	380 - 415	6	GW66009	GW66209	GW66209N	GW66059N	-	GW66982	GW66509
	3P + \perp	500 480 - 500	7	GW66010	GW66210	GW66210N	-	-	GW66983	GW66510
	3P + \perp	110 100 - 130	4	GW66013	GW66213	-	-	-	-	-
32	2P + \perp	230 200 - 250	6	GW66015	GW66215	GW66215N	GW66065N	-	-	-
	3P + \perp	400	6	GW66019	GW66219	GW66219N	GW66069N	-	GW66992	GW66519
	3P + N + \perp	380 - 415	6	GW66020	GW66220	GW66220N	GW66070N	-	GW66993	GW66520
	3P + \perp	500 480 - 500	7	GW66021	GW66221	GW66221N	-	-	GW66994	GW66521
	3P + \perp	380 - 440	3	-	GW66257	-	-	GW66357	GW66996	GW66523
	3P + \perp	400	6	-	-	GW67263N	-	-	GW66873	GW66531
63	3P + N + \perp	380 - 415	6	-	-	GW67264N	-	-	GW66874	GW66532
	3P + \perp	500 480 - 500	7	-	-	GW67265N	-	-	GW66875	GW66533

ELECTRICALLY INTERLOCKED WITH CIRCUIT BREAKER
IP54

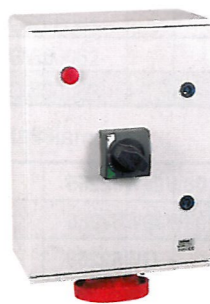

Watertight Vertical Socket Outlet with Safety Transformer IP55

230/24V 160VA Transformer



16A
 GW66260
 2P + E
 Output 24VAC, Input 230VAC
 Fuse supplied:
 2A for primary and 6A for secondary
 Fuse Code E14-2A & E14-6A see page 134-139.

RATED CURRENT (A)	POLES	RATED VOLTAGE (V)	REFERENCE	IP44	IP55	IP67	IP67	IP55	IP66	IP66
125	3P + \perp	400	6	GX66585	-	-	-	-	-	-
	3P + N + \perp	380 - 415	6	GX66586	-	-	-	-	-	-
	3P + \perp	500 480 - 500	7	GX66587	-	-	-	-	-	-

COMPACT BOTTOM ENTRY INTERLOCKED SOCKET OUTLETS

66/67 IB Range interlocked socket-outlets to IEC 309 standards

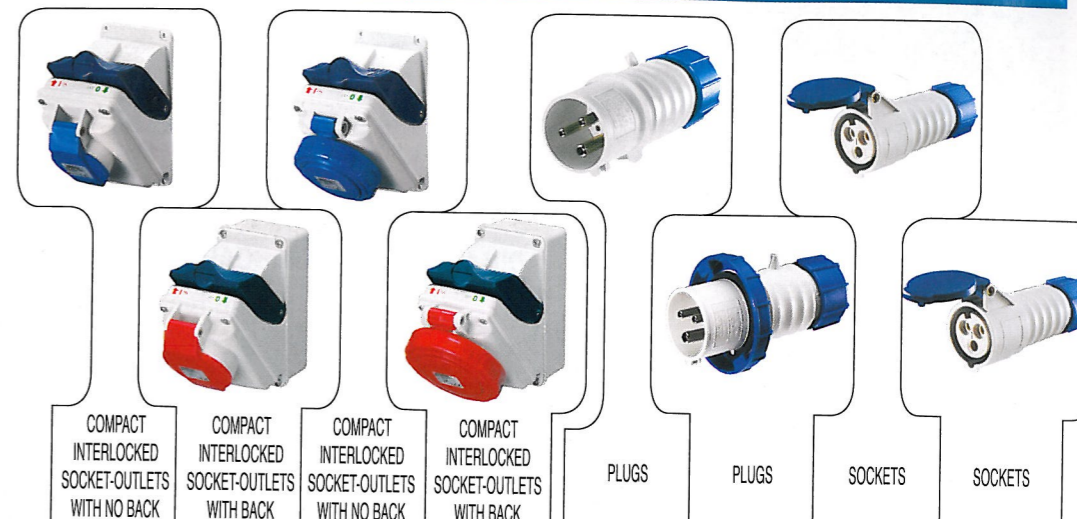

COMPACT INTERLOCKED SOCKET-OUTLETS WITH NO BACK
 COMPACT INTERLOCKED SOCKET-OUTLETS WITH BACK
 COMPACT INTERLOCKED SOCKET-OUTLETS WITH NO BACK
 COMPACT INTERLOCKED SOCKET-OUTLETS WITH BACK
 PLUGS
 PLUGS
 SOCKETS
 SOCKETS

RATED CURRENT (A)	POLES	RATED VOLTAGE (V)	REFERENCE	IP44	IP44	IP55	IP55	IP44	IP67	IP44	IP67
16	2P + \perp	110	4	GW66423	GW66401	GW66467	GW66445	GW61001	GW61023	GW63001	GW63023
	3P + \perp	100 - 130	4	GW66424	GW66402	GW66468	GW66446	GW61002	GW61024	GW63002	GW63024
	2P + \perp	230 200 - 250	6	GW66426	GW66404	GW66470	GW66448	GW61004	GW61026	GW63004	GW63026
	3P + \perp	400	6	GW66430	GW66408	GW66474	GW66452	GW61008	GW61030	GW63008	GW63030
	3P + N + \perp	380 - 415	6	GW66431	GW66409	GW66475	GW66453	GW61009	GW61031	GW63009	GW63031
	3P + \perp	500	7	-	-	-	-	GW61010	GW61032	GW63010	GW63032
	3P + N + \perp	480 - 500	7	-	-	-	-	GW61011	GW61033	GW63011	GW63033
	2P + \perp	110	4	GW66434	GW66412	GW66478	GW66456	-	-	-	-
	3P + \perp	100 - 130	4	GW66435	GW66413	GW66479	GW66457	-	-	-	-
	2P + \perp	230 200 - 250	6	GW66437	GW66415	GW66481	GW66459	-	-	-	-
3P + \perp	400	6	GW66441	GW66419	GW66485	GW66463	-	-	-	-	
3P + N + \perp	380 - 415	6	GW66442	GW66420	GW66486	GW66464	-	-	-	-	

Complimentary Items for 66/67 IB Range Interlocked Socket-outlets
 Empty vertical watertight boards. IP55



GW66493

Code	No. of compact interlocked socket-outlets	No. of DIN Modules	Dispersable power (CEI 23-49) (W)	Application
GW66491	1 (16/32A)	4	10W	
GW66492	2 (16/32A)	8	13W	
GW66493	3 (16/32A)	12	24W	

Code	Description	Application
GW66496	IP55 Back box only, for compact 16/32A.	
GW66498	Flush-mounting box with frame 16/32A. IP55	

Application notes:
 Can be mounted on flush-mounting rectangular box for modular ranges.

GW40422 Cylindrical security/safety lock. Die-cast metal (2 keys supplied)



GW66496

GW66498

GW40422

68Q-DIN DISTRIBUTION BOARDS IP55

DIN 4 DISTRIBUTION BOARDS



Example



GW68017
1 x 16A flange

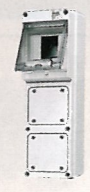

GW68018
2 x 16A flanges

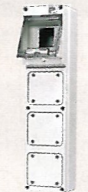

GW68001
3 x 16A flanges



GW68002
Plain lid



Example



GW68003
4 x 16A flanges



GW68019
2 x 16/32A flanges without fuses

DIN 12 DISTRIBUTION BOARDS



GW68004
Plain lid



Example



GW68005
2 x 16/32A flanges



GW68006
2 x 16/32A flanges without fuses

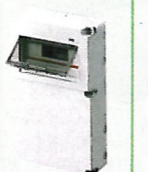

GW68007
Plain lid

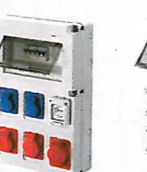

Example

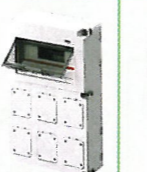

GW68008
6 x 16/32A flanges



GW68009
4 x 16/32A flanges without fuses



Example

DIN 12 DISTRIBUTION BOARDS



Example



GW68010
3 x 16/32A flanges without fuses



GW68011
2 x 16/32A flanges with fuses

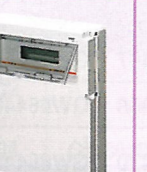

GW68012
Plain lid

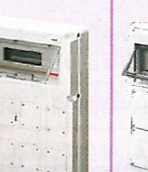

GW68013
8 x 16/32A flanges

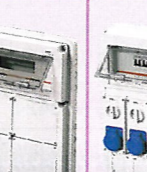

GW68014
4 x 16/32A flanges with fuses

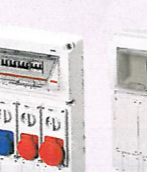

Example

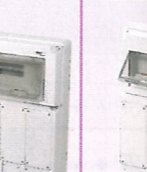

GW68015
4 x 16/32A flanges without fuses



GW68016
3 x 16/32A flanges with fuses

DIN 18 DISTRIBUTION BOARDS

Accessories



GW27401

2 Gang watertight cover for 230V 15A plug. To fit 15A RSA socket **GW20209** and or 13A UK socket **GW20208**



GW68431

Yellow Stand with cable reel, for Q-DIN8



GW68432

Yellow Stand with cable reel and wheels for Q-DIN12/18

Caravan Board – Fully Assembled (Other combinations available)

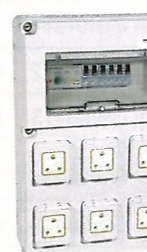

GX98000

Outlets:
6 x 15A RSA Socket
Outlets
Protection:
40A E.L.U
6 x 16A MCB
IP55



GX98016

Outlets:
6 x 16A 2P +
Protection:
40A E.L.U
6 x 10A MCB
IP44



Mobile Distribution Boards – Fully assembled as shown (Other combinations available on request)



Outlets:
2 x 32A 400V 3P+N+E
2 x 16A 400V 3P+E
2 x 16A 230V 2P+E
2 x 16A 230V Domestic
Protection:
1 x 40A 30mA 4P E/L
2 x 16A 1P MCB
1 x 16A 3P MCB
1 x 32A 3P MCB

Code **GX68421**

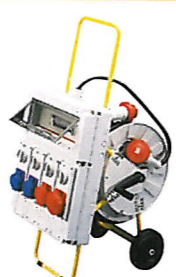

Switched Outlets:
1 x 32A 400V 3P+N+E
1 x 16A 400V 3P+E
2 x 16A 230V 2P+E
Protection:
1 x 40A 30mA 4P E/L
2 x 16A 1P MCB
1 x 16A 3P MCB
1 x 32A 3P MCB

Code **GX68422**



Outlets:
4 x 32A 400V 3P+E
3 x 32A 230V 2P+E
Protection:
1 x 63A 30mA 4P E/L
4 x 32A 3P MCB
3 x 32A 1P MCB

Code **GX68423**

SOCKET OUTLET ENCLOSURES

Surface Mount Boxes

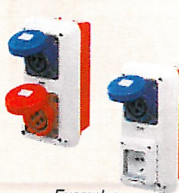

Examples

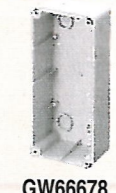

GW66678
1 x 16A Interlock



GW66741
2 x 16A Flange



GW66683
1 x 16A Interlock

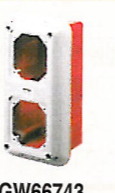

GW66743
2 x 16A Flange

For Horizontal Interlock Sockets

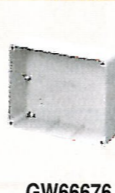

GW66676
1 x 16/32A Flange



GW66681
1 x 16/32A Flange

MARINA DISTRIBUTION TERMINALS



Brilliant for tourist marinas

68 Q-MC Range

With its innovative and functional design, the system solves all the needs for the provision of energy and services in ports, campsites and public areas, perfectly fitting in with the surroundings.

Based on an aluminium tubular frame, Gewiss Marina Terminals are strong and designed to withstand all the combined effects of sun and sea spray.

Many derivatives can be manufactured to incorporate energy metering and billing, fire hydrants, compressed air or fresh water supply. Available locally in blue, white is available ex-indent.

Fully assembled units – Light Blue IP55

Electricity & Water distribution terminals complete with 11W CF Lamp

* Also available in stainless steel

Code	Switched Socket Outlets IEC309	Protection	Water Taps	Size (mm)
GW68841A	2 x 2P + E 16A 230V	2P 16A 30mA E/L	2	300 x 445 x 625
GW68851A	4 x 2P + E 16A 230V	4P 40A 30mA E/L + 4 x 16A DP MCB	4	300 x 445 x 950
GW68853A	2 x 2P + E 16A 230V 1 x 4P + E G3A 400V	4P 80A 30mA E/L + 2 x 16A DP MCB 1 x 63A 4P MCB	4	300 x 445 x 950

Firefighting Terminals – Light Blue

• Accessible from both sides. • Tear off doors. • Provision for optional light

Code	Description	Size (mm)
GW68721A	With seat for extinguisher	300 x 445 x 850
GW68724A	With 15m hose and UNI45 lance, hose holder saddle and stainless steel 1 1/2" insulated extension lead	300 x 445 x 950

Accessories

Code	Description
GW68791	Emergency Lighting Kits: 11W, NiC batteries, 1hr backup
GW68796	Fixing Plate on concrete
GW68781	Fixing Plate for floating pier
GW68776	Key Lock, supplied with 2 keys

INDUSTRIAL SITE DISTRIBUTION BOARDS



GW68465

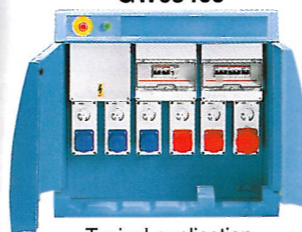

Typical application



GW68466



GW68463

Code	Description
4-way Board - IP55	
GW68465	Terminal blocks supplied: Supply - No. poles x sect. (mm ²). (5 x 25/35). Earth - No. poles x sect. (mm ²). (7 x 10).
6-way Board - IP55	
GW68466	Terminal blocks supplied: Supply - No. poles x sect. (mm ²). (5 x 25/35). Earth - No. poles x sect. (mm ²). (2 x 25) + (10 x 10).

Accessories

GW68463 Metal support painted in yellow for 68Q-Box 4/6 way

ISOLATORS

Panel Mounting (Open Type) With IP65 padlockable red/yellow handle, door interlocking with shaft

Code	Pole	AC21 400V	AC23 400V	Terminal Capacity	Panel Depth	Qty/ Box
GW70002	3	16A	5.5kW	6mm ²	87 - 145mm	10
GW70003	4	16A	5.5kW	6mm ²	87 - 145mm	10
GW70005	3	32A	11kW	16mm ²	87 - 145mm	10
GW70006	4	32A	11kW	16mm ²	87 - 145mm	10
GW70007	3	63A	22kW	25mm ²	114 - 177mm	5
GW70008	4	63A	22kW	25mm ²	114 - 177mm	5
GW70202	3	16A	3kW	4mm ²	DIN DB	30
GW70205	3	32A	11kW	10mm ²	DIN DB	24
GW70206	4	32A	11kW	10mm ²	DIN DB	24

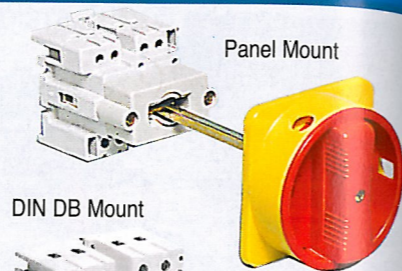

Accessories

Code	Amps	Description	Qty/Box
GW70009	16 / 32 / 63A	Galvanized Steel adj. extension Brackets 117- 305mm	10
GW70409	16/32A	Spare Red/Yellow Handle	20
GW70410	63A	Spare Red/Yellow Handle	18

Enclosed (Surface Mounting) IP65 With padlockable red/yellow handle

Code	Pole	AC21 400V	AC23 400V	Terminal Capacity	Dimensions	Qty/ Box
GW70431	2	16A	2.2kW	6mm ²	114 x 114 x 72	16
GW70432	3	16A	5.5kW	6mm ²	114 x 114 x 72	16
GW70433	4	16A	5.5kW	6mm ²	114 x 114 x 72	16
GW70434	2	32A	7.5kW	16mm ²	114 x 114 x 72	16
GW70435	3	32A	11kW	16mm ²	114 x 114 x 72	16
GW70436	4	32A	11kW	16mm ²	114 x 114 x 72	16
GW70437	3	63A	27kW	25mm ²	170 x 170 x 96	6
GW70438	4	63A	27kW	25mm ²	170 x 170 x 96	6
GW70509	3	80A	35kW	50mm ²	165 x 175 x 135	1
GW70510	4	80A	35kW	50mm ²	165 x 175 x 135	1
GW70511	3	100A	35kW	50mm ²	165 x 175 x 135	1
GW70512	4	100A	35kW	50mm ²	165 x 175 x 135	1
GW70513	3	125A	45kW	50mm ²	240 x 190 x 160	1
GW70514	4	125A	45kW	50mm ²	240 x 190 x 160	1



GW70431-8



GW70513/4

For larger size Isolators see page 96.

MULTIPOLE CONNECTORS IP65

Bases for 3 or 4 pole

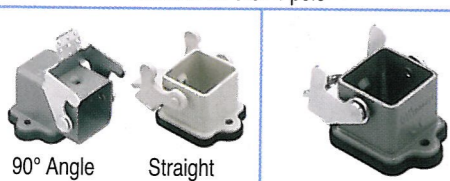

Plastic	Metal
Straight - GW76201	Straight - GW76202
90° Angle - GW76203	90° Angle - GW76204

Connectors 10A 250V



No. of Poles	Female	Male
3 Pole + E	GW76001	GW76101
4 Pole + E	GW76002	GW76102

Dimensions
H x W x Fixing Hole Centres

24.5 x 35 x 30	24.5 x 35 x 30
41.5 x 42 x 30	41.5 x 42 x 30



Hoods for 3 or 4 pole

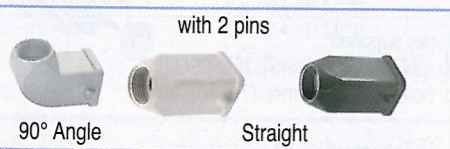

Gland Size	Plastic	Metal
M20	Straight - GW76227	Straight - GW76228
M20	90° Angle - GW76229	90° Angle - GW76230

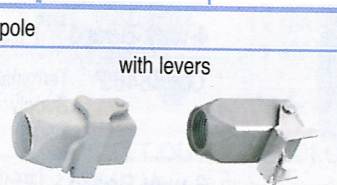

Plastic	Metal
Straight - GW76231	Straight - GW76232
-	-

Protection Caps with retaining cable

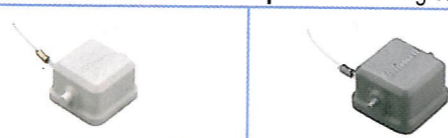

Plastic	Metal
For Female Connector - GW76801	For Female Connector - GW76803
For Male Connector - GW76802	For Male Connector - GW76804

Dimensions H x W x L

M20	35 x 26.5 x 54	35 x 26.5 x 54
-----	----------------	----------------

Dimensions H x W x L

35 x 26.5 x 17.5	35 x 26.5 x 17.5
------------------	------------------

MULTIPOLE CONNECTORS IP65

Bases

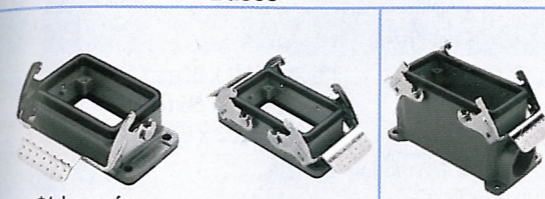

*1 Lever for 6 Pole + E

with 2 levers

with levers

Hoods

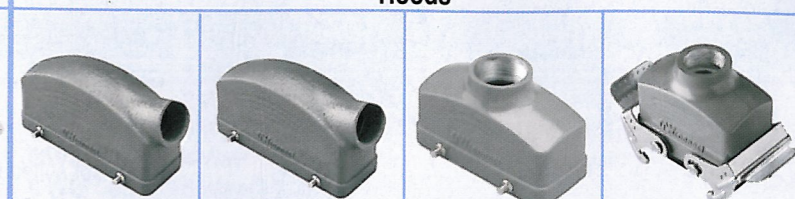

High Profile hood

without levers

without levers

with levers

No. of Poles	Gland Size	Flush Rear Entry	Surface 1 x Gland Entry	Side Entry	Side Entry	Top Entry	Top Entry
*6 Pole + E	PG 16	*GW76401	*GW76301	-	GW76502	GW76504	GW76531
10 Pole + E	PG 16	GW76412	GW76322	-	GW76519	GW76520	GW76536
10 Pole + E	PG 21	GW76412	-	GW76471	-	GW76421	-
16 Pole + E	PG 21	GW76413	GW76324	GW76473	GW76521	GW76522	GW76537
24 Pole + E	PG 21	GW76414	GW76326	GW76475	GW76523	GW76524	GW76538
32 Pole + E	PG 36	GW76415	GW76328	-	GW76526	GW76529	GW76540
48 Pole + E	PG 36	GW76411	GW76321	-	GW76514	GW76517	-

*6 Pole + E only with 1 lever, all other with 2 levers

Dimensions H x W x L

6 Pole + E	PG 16	29.5 x 44 x 82	53 x 57 x 83.5	-	47 x 43.5 x 60	53 x 43.5 x 60	59 x 43.5 x 60
10 Pole + E	PG 16	29.5 x 53.5 x 95.5	57 x 57 x 97	-	52 x 43.5 x 73.5	58 x 43.5 x 73.5	64 x 43.5 x 73.5
10 Pole + E	PG 21	29.5 x 53.5 x 95.5	-	80 x 43.5 x 73.5	-	97 x 43.5 x 73.5	-
16 Pole + E	PG 21	29.5 x 53.5 x 115.5	63 x 57 x 117	80 x 43.5 x 94	63 x 43.5 x 93.5	58 x 43.5 x 93.5	64 x 43.5 x 93.5
24 Pole + E	PG 21	29.5 x 53.5 x 142.5	63 x 57 x 143.5	80 x 43.5 x 120.5	63 x 43.5 x 129.5	68 x 43.5 x 120.5	74 x 43.5 x 120.5
32 Pole + E	PG 36	29.5 x 105 x 124.5	87.5 x 84.5 x 125	-	94 x 83 x 94	113 x 83 x 94	119 x 83 x 94

Connectors 16A 500V

No. of Poles	Male	Female	Terminal No.
6 Pole + E	GW76103	GW76003	1-6
10 Pole + E	GW76104	GW76004	1-10
16 Pole + E	GW76105	GW76005	1-16
24 Pole + E	GW76107	GW76007	1-24
32 Pole + E	GW76105	GW76005	1-16
	GW76106	GW76006	17-32
48 Pole + E	GW76107	GW76007	1-24
	GW76108	GW76008	25-48

Optional Covers

No. of Poles	For Base	For Hood
6 Pole + E	GW76813	GW76818
10 Pole + E	GW76805	GW76809
16 Pole + E	GW76806	GW76810
24 Pole + E	GW76807	GW76811
32 Pole + E	GW76808	GW76812

Accessories

PG Size	Cable Size	Code	Code	Code	Code	PG Size	Pipe Size	Code	Code
PG 16	7.5-15mm	GW76827	GW76843	CRS16	GW52005	PG 16	16mm	DX54417	GW76867
PG 21	10-19mm	GW76828	GW76844	CRS21	GW52006	PG 21	20mm	DX54420	From PG21 to PG16 GW76868
PG 29	17-24mm	GW76829	-	-	-	PG 29	25mm	DX54425	From PG29 to PG21 GW76869
PG 36	24-33mm	GW76830	GW76846	CRS36	-	PG 36	32mm	DX54432	From PG36 to PG29

NEW

CHORUS SURFACE MOUNTING ENCLOSURES



Self-Supporting, Empty, Protected Enclosures **IP40**

Code	Description	Type	Pack Size
GW16502	2 Gang	66 x 82 x 56mm	5
GW16503	3 Gang	99 x 82 x 56mm	3
GW16504	4 Gang	132 x 82 x 56mm	1

Note: Not suited to receive 1/2 module devices.

Self-Supporting, Empty, Watertight Enclosures **IP55**

Code	Description	Type	Pack Size
GW16512	2 Gang	66 x 82 x 67mm	5
GW16513	3 Gang	99 x 82 x 67mm	2
GW16514	4 Gang	132 x 82 x 67mm	1

Note: Not suitable for the installation of 1/2 module devices.

NEW

CHORUS PRE-ASSEMBLED DESKTOP CONTROLS

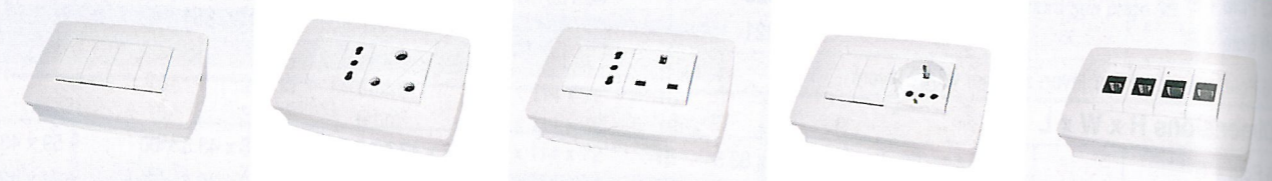

Code	GX041TB	GX042TB	GX043TB	GX044TB	GX045TB
------	---------	---------	---------	---------	---------



Code	GX061TB	GX062TB	GX063TB	GX064TB	GX065TB
------	---------	---------	---------	---------	---------

NEW

LED MODULAR FLUSH-MOUNTING LIGHTING IP67

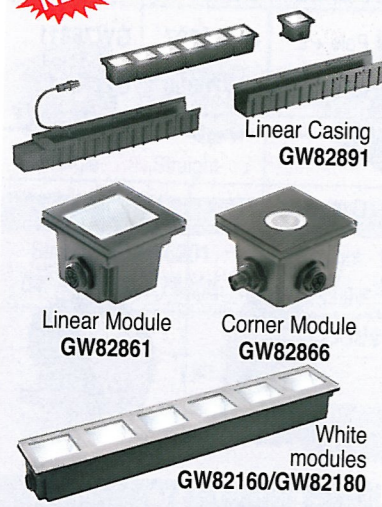

Metrolight Modular LED Lighting System

LED lighting system with wall washer optics consisting of combinable modules. Resistant to 500kg static load.

Code		No. of Modules	Power	Description
Black	White			
Pure White Modules 5000K. Supply voltage: 220/230VAC				
GW82860	GW82160	6	24W	Complete 6 modules kit c/w outer casing, end caps & lights
GW82861	GW82161	1	4W	Single linear lighting module
GW82866	GW82166	1	4W	Corner lighting module (Right angle)
GW82867	GW82167	1	4W	Corner lighting module (Left angle)
GW82870	GW82170	1	-	Un-wired blank joining module
RGB Modules DMX control. Supply voltage: 100/240VAC				
GW82880	GW82180	6	18W	Complete 6 modules kit c/w outer casing, end caps & lights
GW82871	GW82171	1	3W	Single linear lighting module
GW82876	GW82176	1	3W	Corner lighting module (Right angle)
GW82877	GW82177	1	3W	Corner lighting module (Left angle)

Accessories

Code	Description	Code	Description
GW82891	Linear outer casing 6 modules	GW85691	RGB controller for up to 20 devices. Can be mounted in a chorus 3-gang frame.
GW82892	Corner outer casing 3 modules	GW85692	DMX repeater/splitter with 4 outputs. To increase the number of devices controlled.
GW82893	Black outer casing end cap	GW82895	Power supply connector for RGB 5-Poles
GW82899	White inner casing end cap		
GW82894	Power supply connector 3-Poles		

RCC Cert. 0707039

ENCLOSURES & SURFACE MOUNTING MODULAR COMPONENTS



Indoor empty enclosures **IP40**

Code	Description	Type	Pack Size
GW27001	1 Way	Horizontal	5
GW27002	2 Way	Horizontal	5
GW27003	3 Way	Horizontal	3
GW27004	4 Way	Horizontal	1
GW27005	6 Way (3 x 2)	Horizontal	1
GW27006	8 Way (4 x 2)	Horizontal	1
GW27007	12 Way (4 x 3)	Horizontal	1
GW27008	16 Way (4 x 4)	Horizontal	1
GW27021	4 Way (2 x 2)	Vertical	1
GW27022	6 Way (2 x 3)	Vertical	1
GW27023	8 Way (4 x 2)	Vertical	1
GW27024	12 Way (4 x 3)	Vertical	1



Weather Proof empty enclosures **IP55**

Code	Description	Type	Pack Size
GW27041	1 Way	66 x 82 x 65	5
GW27042	2 Way	66 x 82 x 65	5
GW27043	3 Way	99 x 82 x 65	3
GW27044	4 Way	132 x 82 x 65	3
GW27051	8 Way (4 x 2)	132 x 171 x 65	1
GW27052	12 Way (4 x 3)	132 x 258 x 65	1
GW27057	3 Way Pole Mount, 54 to 76mmØ		1

Fixing by screw or cable ties

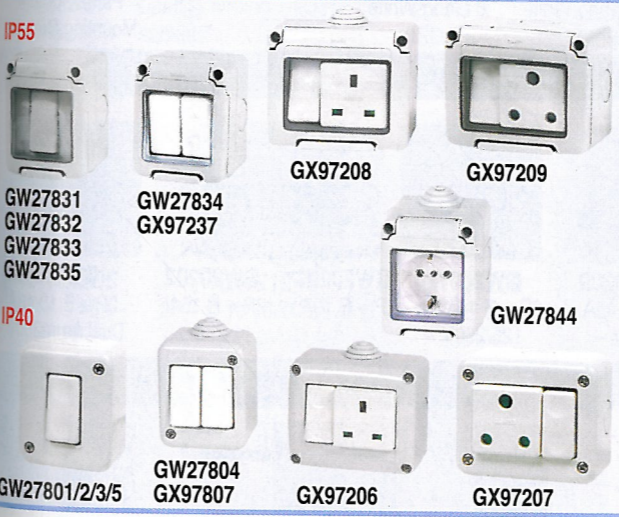

Enclosures complete with switches

Indoor IP40	Description	Weather Proof IP55
GW27801	16A 1P 1 lever	GW27831
GX97807	16A 1P 2 lever	GX97237
GW27802	16A 2P 1 lever	GW27832
GW27803	16A two-way 1 lever	GW27833
GW27804	16A two-way 2 lever	GW27834
GW27805	16A N/O pushbutton 1 lever	GW27835
GX97206	British 13A switched socket	GX97208
GX97207	R.S.A. 15A switched socket	GX97209
GW27814	German 16A Schuko socket	GW27844

Combined Enclosures for Modular Devices

Indoor IP40	Modules	No of way
GW27071	2	4
GW27072	4	8
GW27073	8	16

Typical Application



20 SYSTEM RANGE WHITE

One-Way Switches

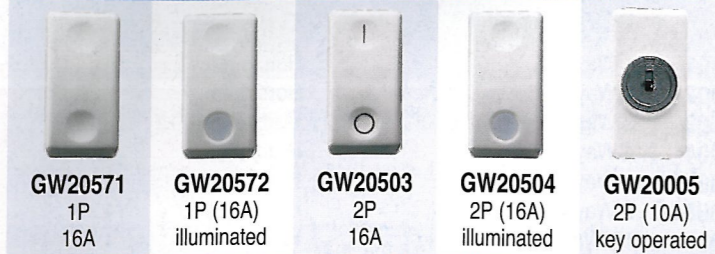

Two-Way Switches 10A

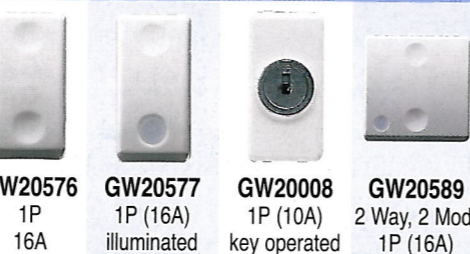

Intermediate Switch



Pushbuttons 10A

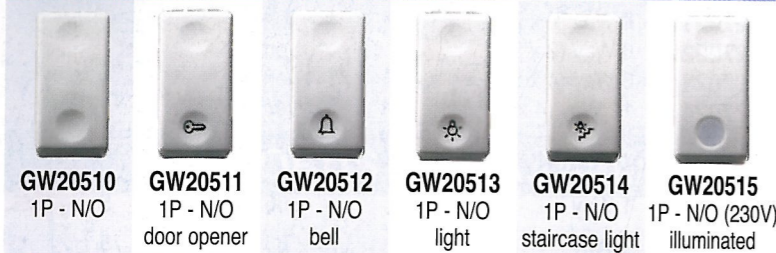

Stove Isolator



Blank Plates



Shaving Socket



TV Sockets



Telephone Sockets



Chimes/Buzzers



Desktop/Surface Consoles



Supporting Brackets



French Socket



Italian/German (standard)



British/RSA (standard)



Euro/USA

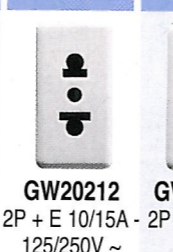

Italian

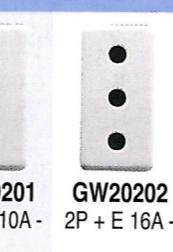

Indicating Lamps

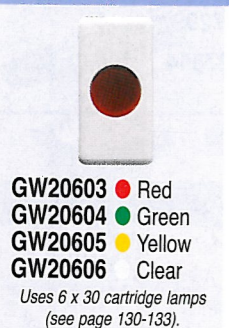

Infrared detector

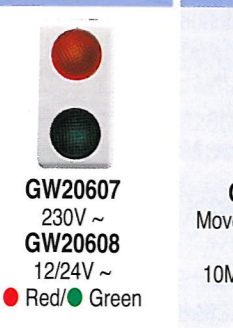

Latching Relays

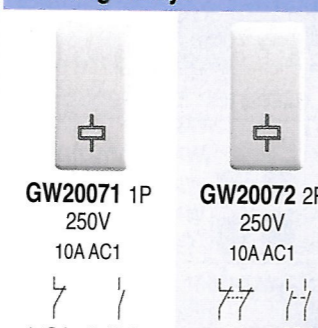

Bell Push Button



Computer Socket



Thermostats

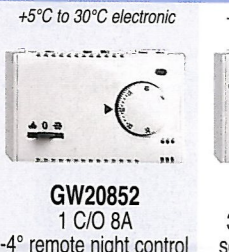

Dimmers (Resistive: 230V Lamps/Inductive: Low Voltage transformers)

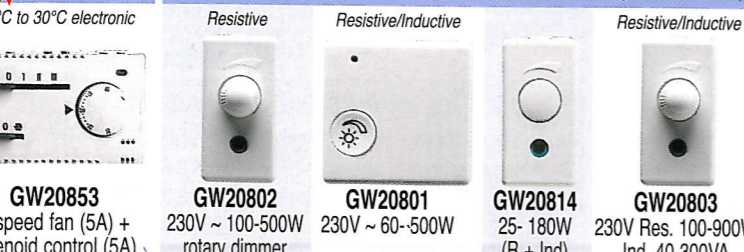

Circuit Breakers / ELU



20 SYSTEM RANGE BLACK

One-Way Switches



Two-Way Switches 10A



Intermediate Switch



Pushbuttons 10A



Stove Isolator



Blank Plates



Computer Socket



TV Sockets



Telephone Sockets



Chimes/Buzzers



Desktop/Surface Consoles



Italian/German (standard)



British/RSA (standard)



Euro/USA



Italian



Indicating Lamps



Infrared detector



Shaving Socket



Latching Relays

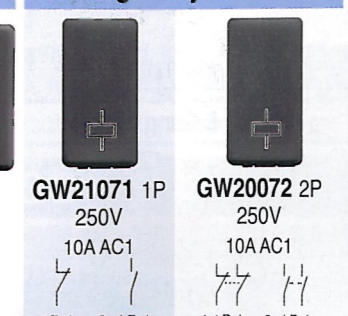

Lamps 230V



Thermostats



Dimmers (Resistive: 230V Lamps/Inductive: Low Voltage transformers)



VIRNA PLATES

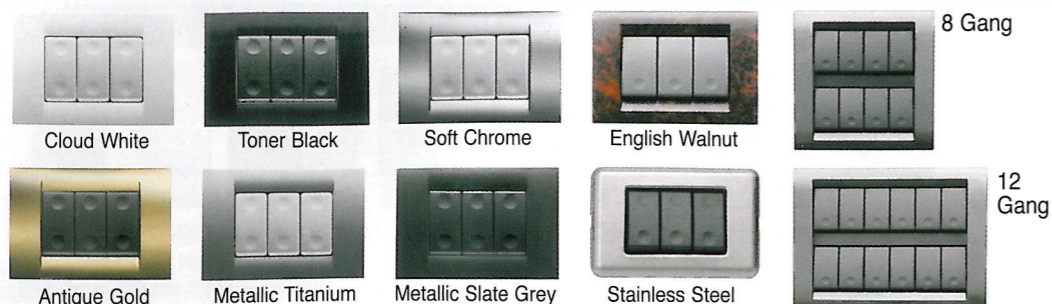

Colour	1 Gang	2 Gang	3 Gang	4 Gang	6 Gang	8 Gang	12 Gang
White	GW22101	GW22102	GW22103	GW22104	GW22106	GW22107	GW22108
Toner Black	GW22111	GW22112	GW22113	GW22114	GW22116	GW22117	-
Soft Chrome	GW22251	GW22252	GW22253	GW22254	GW22256	GW22257	-
Antique Gold	GW22261	GW22262	GW22263	GW22264	GW22266	GW22267	-
English Walnut	GW22271	GW22272	GW22273	GW22274	GW22276	GW22277	-
Metallic Titanium	GW22281	GW22282	GW22283	GW22284	GW22286	GW22287	GW22288
Metallic Slate	GW22291	GW22292	GW22293	GW22294	GW22296	GW22297	GW22298
Stainless Steel	GW22207	-	GW22208	GW22209	-	-	-

CLASSIC PLATES

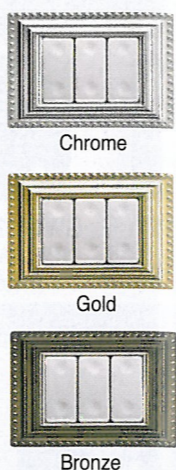

Colour	3 Gang	4 Gang
Chrome	GW22213	GW22214
Gold	GW22223	GW22224
Bronze	GW22233	GW22234

SUPPORTS FOR VIRNA & CLASSIC SYSTEM RANGE



1, 2 & 3 Gang	1 & 3 Gang	2 Gang	4 Gang	6 Gang	8 Gang	12 Gang
GW22451	GW24201	GW24262	GW24202	GW24230	GW24240	GW24241

Mounting Boxes for Virna, Classic and TOP System Range

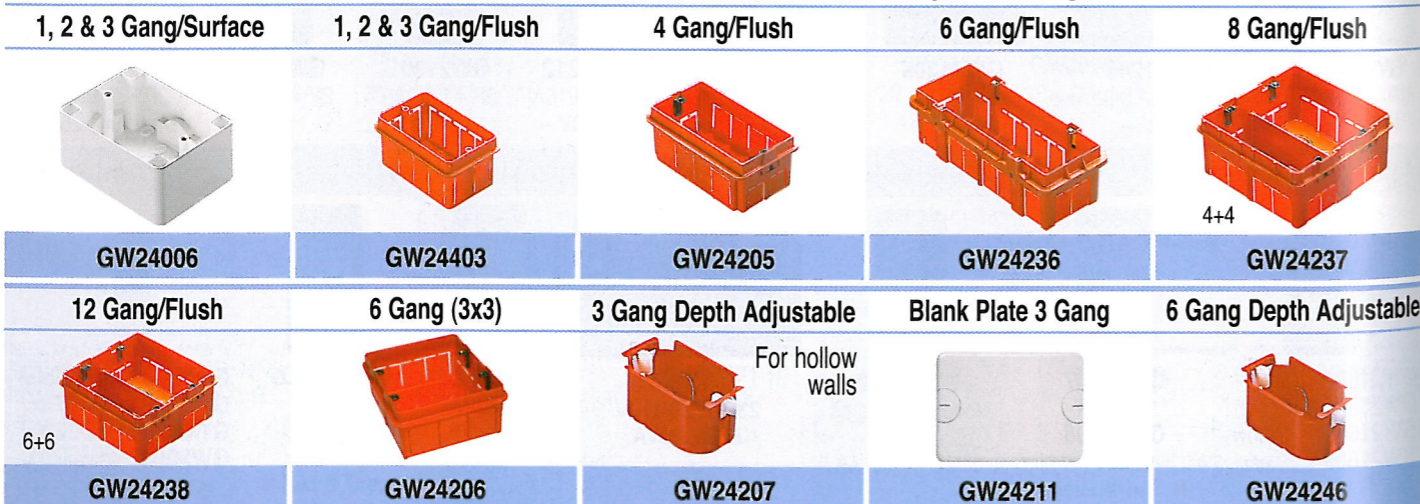

	P3 P3 Discounts Apply			Other Wall Boxes 4 x 2		
	Flush			Surface Ext. Boxes		
TM-2020 Conforms to SABS Spec. No. IEC60670-1						
Code	TM-2020	TM-42S	TC-PR42	EB42	EB42C	PEB42
Size mm	105.5 x 61 x 50D	105 x 65 x 45D	105 x 61 x 50D	50 x 100mm		

SYSTEM RF



The System RF is a range of radio frequency devices giving you the opportunity to move switches without chasing masonry, damaging paintwork or laying cables. You now have the freedom to control lights and other electrical equipment up to 100m from where the original switch used to be. The refined design enables colour co-ordination to match the rest of your Gewiss switches in your Home, Office or Hotel. Quick to install, easy to use. Fully compatible with Sytem Black/White.

Transmitters

	Pushbutton Panels			Hand Controller	Volt Free Contact Input	IR Movement Detector
	Fix on any indoor surface mount			Giving you personal command from anywhere	Actuated from any volt free contact	Automatic light switch-on
	1 ch	2 ch	3 ch	3 ch 6 btn	1 ch	1 ch
Supply	2 x AAA	2 x AAA	2 x AAA	2 x AAA	230V	3 x AAA
White plate/White lever	GW20991	GW20992	GW20993	GW20963	GW20966	GW20990
Met. Titanium plate/black lever	GW21991	GW21992	GW21993	-	GW21966	GW21990

Note: All transmitters (except hand controller) can use any other colour of system cover. Anticipated battery life is 2 years. Batteries not included.

Receivers

	Standard Loads 1ch 1 mod		Large Loads 1ch 2 mod	Motor Control 1ch 2 mod
Supply	230VAC		230VAC	230VAC
Output	1N.O. 3A 230V		1N.O. 16A 230V	2 x N.O. 8A 230V
Application	On-Off, dimmable or timed		On-Off, dimmable or timed	Awnings, doors, gates
White	GW20980		GW20981	GW20982
Black	GW21980		GW21981	GW21982

Note: The single output receivers have a button on the front for manual operation. The two output receiver has 3 buttons for Up/Down or Auto. The single output receivers can be used for on-off switching, dimming and timed functions such as a stairwell light to remain on while you leave.

20 SYSTEM RANGE

Infrared Detector	Buzzers IP40	Stair Riser Lights	Emergency Lamps	Cartridge Lamp	TV Loop End Resistor
GW27431 12m 5-50LUX (adj.) 10-300sec on timer 1NO 3A@250V	GW26417 24V 70dB GW26427 230V 70dB	GW20601 White GW20623 Red GW20624 Green GW20625 Yellow GW20626 Blue Uses S6 x 36 cartridge lamps	GW20806 230V ~ 2 hours back-up	GW20902 S6 x 36mm 12V white GW20903 S6 x 36mm 24V white GW20906 S6.3 x 28mm 110/230V red GW20908 S6.3 x 28mm 110/230V green	GW20227 75 Ohm terminal resistance



CHORUS MODULAR DEVICES – WHITE

One-Way Switches

GW10001 1M - 1P - 16AX General	GW10002 1M - 1P - 16AX Localisation	GW10021 1/2M - 1P - 10AX General	GW10022 1/2M - 1P - 10AX Localisation	GW10031 2M - 1P - 16AX General	GW10004 1M - 2P - 16AX General	GW10007 1M - 2P - 25AX Heavy-duty	GW10034 2M - 2P - 16AX General

Two-way Switches

GW10051 1M - 1P - 16AX General	GW10052 1M - 1P - 16AX Localisation	GW10061 1/2M - 1P - 10AX General	GW10071 2M - 1P - 16AX General

Three-Way

GW10121 1M - 1P - 16AX Positions 1-0-2

Reversing

GW10091 1M - 1P - 16AX General

Blanking Modules

GW10195 1 Gang	GW10198 2 Gang

Push-Buttons

GW10131 1M - 1PN - 16A General	GW10132 1M - 1PN - 16A Localisation	GW10136 1M - 1PN - 16A With pull-cord	GW10161 1/2M - 1PN - 10A General	GW10171 2M - 1PN - 16A General	GW10191 2M - 1PN - 10A With illuminated name plate	GW10040 Universal badge switch 1 gang - NO - 16AX

Hotel

Infrared

GW10591 IR movement detector 1NA-3A	GW10592 Infrared movement detector 1NA-16A	GW12596 Portable 6 channel remote control

Dimmers

GW10561 Res 100-500W 230VAC	GW10564 Res 100-900W Ind. 40-300VA 230VAC - 12V AC/DC	GW10568 Res 60-500W Ind. 60-500VA 230VAC	GW10571 Res 40-300W For electronic transformers 230VAC

Relays

GW10721 Step-step 1 gang - 10AX 230VAC	GW10723 4 sequences 2 gangs - 10AX 230VAC	GW10724 Monostable 1 gang - 1NA NO

Italian

GW10201 2P+E 10A 250VAC	GW10203 2P+E 16A 250VAC Dual amperage

Italian/German

GW10204 2P+E 16A 250VAC Dual amperage	GW10205 2P+E 16A 250VAC

German

GW10241 2P+E 16A 250VAC

French

GW10247 2P+E 16A 250VAC

Euro/USA

GW10287 2P 15A 250/125VAC

British/RSA

GW10296 2P+E 13A 240VAC

Switched Socket

GW10297 2P+E 15A 240VAC

Switched Socket

GW10321 2P+E 16A 230VAC

Shaving Socket

GW10331 Shower socket/outlet 230VAC - 50/60Hz



CHORUS MODULAR DEVICES – WHITE

TV / SAT / FM

Male IEC type GW10361 0db GW10362 5db GW10363 10db GW10364 14db GW10365 18db GW10366 22db GW20277 Resistance 75Ω terminal	Female F type GW10371 0db GW10372 5db GW10373 10db GW10374 14db GW10375 18db GW10376 22db GW20277 Resistance 75Ω terminal	GW10381 TV - FM 0db	GW10382 TV - FM - SAT 0db	GW10453 Double RCA	GW10456 HDMI conn.	GW10457 USB conn.

Telephone and Communication Connectors

GW10401 RJ11 In/Out	GW10402 RJ11 Double	GW10403 RJ11 Double	GW10404 RJ12	GW10421 RJ45 5e UTP	GW10422 RJ45 5e FTP	GW10423 RJ45 6 UTP	GW10424 RJ45 6 FTP	GW10441 SUB - D 9 contacts	GW10442 SUB - D 15 contacts	GW10443 SUB - D 25 contacts

Clock

GW10708 Clock/alarm/thermometer 230VAC - 50/60Hz

Thermostats

GW10703 Timer thermostat 230VAC - 50/60Hz	GW10701 White wall-mounting timed thermostat GW14701 Titanium wall-mounting timed thermostat	GW10705 Thermostat 230VAC - 50/60Hz

Buzzers and Ringers

GW10606 Buzzer 12VAC 50Hz	GW10607 Buzzer 230VAC 50Hz	GW10611 Ringer with three independent inputs 12V AC/DC	GW10612 Ringer with three independent inputs 230VAC 50Hz

CHORUS MODULAR DEVICES – TITANIUM

TV / SAT / FM

Male EC type GW14361 0db GW14362 5db GW14363 10db GW14364 14db GW14365 18db GW14366 22db GW20277 Resistance 75Ω terminal	Female F type GW14371 0db GW14372 5db GW14373 10db GW14374 14db GW14375 18db GW14376 22db GW20277 Resistance 75Ω terminal	GW14381 TV - FM 0db	GW14382 TV - FM - SAT 0db	GW14453 Double RCA	GW14456 HDMI conn.	GW14457 USB conn.

Telephone and Communication Connectors

GW14401 RJ11 In/Out	GW14402 RJ11 Double	GW14403 RJ11 Double	GW14404 RJ12	GW14421 RJ45 5e UTP	GW14422 RJ45 5e FTP	GW14423 RJ45 6 UTP	GW14424 RJ45 6 FTP	GW14441 SUB - D 9 contacts	GW14442 SUB - D 15 contacts	GW14443 SUB - D 25 contacts

Clock

GW14708 Clock/alarm/thermometer 230VAC - 50/60Hz

Thermostats

GW14703 Timer thermostat 230VAC - 50/60Hz	GW10701 White wall-mounting timed thermostat GW14701 Titanium wall-mounting timed thermostat	GW14705 Thermostat 230VAC - 50/60Hz

Buzzers and Ringers

GW14606 Buzzer 12VAC 50Hz	GW14607 Buzzer 230VAC 50Hz	GW14611 Ringer with three independent inputs 12V AC/DC	GW14612 Ringer with three independent inputs 230VAC 50Hz