

SINGLE PHASE PETROL GENERATORS - 230 VAC

NEW RANGE



KGE2500X



KGE6500E/X



KGE12E

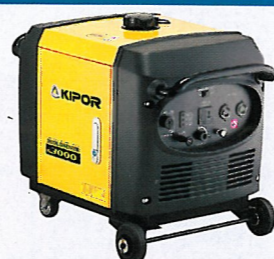

Petrol Silent - Digital IP33

Code	Petrol Open Frame IP23					Petrol Silent - Digital IP33	
	KGE2500X	KGE4000X	KGE6500E	KGE6500X	KGE12E	IG3000	IG6000
Rated Output kVA/kW	2/1.8	3/2.7	5/4.5	5/4.5	8.5/7.65	2.3/2.07	5.5/4.95
Starting	Recoil	Recoil	Electric	Recoil	Electric	Electric/ Recoil	Electric
DC Output	Yes	Yes	Yes	Yes	Yes	Yes	Yes
Rated Current	8.7A	13A	21.7A	21.7A	36.9A	9.6A	23.9A
Engine Type	Single cylinder, 4 stroke, Air cooled	Single cylinder, 4 stroke, Air cooled	Single cylinder, 4 stroke, Air cooled	Single cylinder, 4 stroke, Air cooled	V-Twin, 4 stroke, Air cooled	Single cylinder, 4 stroke, Air cooled	Single cylinder, 4 stroke, Air cooled
Fuel Tank	25ℓ	30ℓ	30ℓ	30ℓ	25ℓ	13ℓ	22ℓ
Displacement	196cm³	277cm³	389cm³	389cm³	688cm³	196cm³	389cm³
Size (mm)	590 x 430 x 430	675 x 520 x 540	675 x 520 x 540	675 x 520 x 540	910 x 600 x 760	684 x 440 x 505	802 x 495 x 624
Dry weight	43kg	71kg	90kg	83kg	161kg	57kg	96.5kg
Noise Level (7m)	66dB	69dB	74dB	74dB	77dB	63-73dB	65-75dB
Standard Items	Fuel gauge, voltmeter, AVR, Engine oil alarm, Circuit breaker, Battery for electric start					Indicator light, Overload protection, Low oil alarm, Battery	
Wheels	Incl.	Incl.	Incl.	Incl.	Incl.	Incl.	Incl.

SINGLE PHASE DIESEL GENERATORS - 230VAC



KDE3500E



KDE12EA



KDE6500T



KDE19STA

Code	Diesel Open Frame IP23					Diesel Silent IP33				
	KDE3500E	KDE3500X	KDE6500E	KDE6500X	KDE12EA	KDE3500T	KDE6500T	KDE12STA	KDE19STA	KDE25SS
Rated Output kVA/kW	2.8/2.52	2.8/2.52	4.5/4.05	4.5/4.05	8.5/7.65	2.8/2.52	4.5/4.05	8.5/7.65	14.4/13	18.5/16.65
Starting	Electric	Recoil	Electric	Recoil	Electric	Electric	Electric	Electric	Electric	Electric
DC Output	Yes	Yes	Yes	Yes	Yes	Yes	Yes	N/A	N/A	N/A
Rated Current	12.2A	12.2A	19.6A	19.6A	37A	12.2A	19.6A	37A	62.6A	80A
Engine Type	Single Cylinder, 4-Stroke, Air cooled	Single Cylinder, 4-Stroke, Air cooled	Single Cylinder, 4-Stroke, Air cooled	Single Cylinder, 4-Stroke, Air cooled	V-Twin, 4-Stroke, Water cooled	Single Cylinder, 4-Stroke, Air cooled	Single Cylinder, 4-Stroke, Air cooled	V-Twin, 4-Stroke, Water cooled	3-cylinder, 4-Stroke, Water cooled	4-cylinder, 4-Stroke, Water cooled
Fuel Tank	13.5ℓ	13.5ℓ	13.5ℓ	13.5ℓ	25ℓ	15ℓ	15ℓ	26ℓ	38ℓ	95ℓ
Displacement	296cm³	296cm³	418cm³	418cm³	794cm³	296cm³	418cm³	794cm³	1048cm³	2771cm³
Size (mm)	655x480x530	655x480x530	720x492x655	720x492x655	1030x600x790	830x532x740	912x532x740	1350x795x850	1540x700x810	1900x950x1200
Dry weight	70kg	65kg	100kg	95kg	200kg	140kg	158kg	310kg	442kg	960kg
Noise Level (7m)	77dB	77dB	77dB	77dB	85dB	72dB	72dB	72dB	72dB	51dB
Standard Items	See single phase specs above.					See three phase silent				
Wheels	Incl.	Incl.	Incl.	Incl.	Incl.	Incl.	Incl.	Incl.	Incl.	-

THREE PHASE GENERATORS - 400VAC

NEW RANGE



KGE6500E3/X3



KDE12EA3



KDE6500T3

Code	Petrol Open Frame IP23			Diesel Open Frame IP23			Diesel Silent IP33		
	KGE6500E3	KGE6500X3	KGE12E3	KDE6500E3	KDE6500X3	KDE12EA3	KDE6500T3	KDE12STA3	
Frame type	Open	Open	Open	Open	Open	Open	Silent	Silent	
Rated Output kVA/kW	5.5/4.4	5.5/4.4	9.5/7.6	5.5/4.4	5.5/4.4	10/8	5.5/4.4	10/8	
Starting	Electric	Recoil	Electric	Electric	Recoil	Electric	Electric	Electric	
Rated Current	8A	8A	13.7A	7.9A	7.9A	14.5A	7.9A	14.5A	
Engine Type	Single cylinder, 4 stroke, Air cooled	Single cylinder, 4 stroke, Air cooled	V-Twin, 4 stroke, Air cooled	Single cylinder, 4 stroke, Air cooled	Single cylinder, 4 stroke, Air cooled	V-Twin, 4 stroke, Water cooled	Single cylinder, 4 stroke, Air cooled	V-Twin, 4 stroke, Water cooled	
Fuel Tank	30ℓ	30ℓ	25ℓ	13.5ℓ	13.5ℓ	25ℓ	15ℓ	26ℓ	
Displacement	389cm³	389cm³	688cm³	418cm³	418cm³	794cm³	418cm³	794cm³	
Size (mm)	675 x 520 x 540	675 x 520 x 540	910 x 600 x 760	720 x 492 x 655	720 x 492 x 655	1030 x 600 x 790	912 x 532 x 740	1350 x 795 x 850	
Dry weight	90kg	83kg	161kg	100kg	95kg	200kg	165kg	310kg	
Noise Level (7m)	74dB	74dB	77dB	79dB	79dB	85dB	72dB	72dB	
Standard Items	See single phase petrol specification			See single phase petrol specification			See below	See single phase petrol specification	See below
Wheels	Incl.	Incl.	Incl.	Incl.	Incl.	Incl.	Incl.	Incl.	

THREE PHASE SILENT DIESEL GENERATORS - 400VAC IP44



KDE13SS3



KDE35SS3

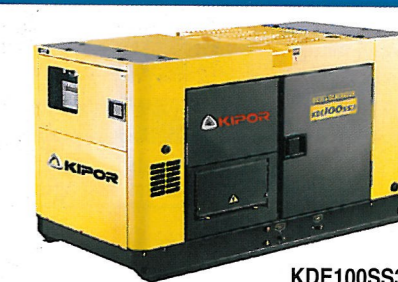

KDE100SS3

Code	Diesel Ultra Silent							
	KDE13SS3	KDE20SS3	KDE30SS3	KDE35SS3	KDE45SS3	KDE60SS3	KDE75SS3	KDE100SS3
Rated Output kVA/kW	10.6/8.5	17/13.6	24/19.2	28/22.4	37/29.6	50/40	62/49.6	80/64
Starting	Electric	Electric	Electric	Electric	Electric	Electric	Electric	Electric
Rated Current	15.3A	24.5A	34.6A	40.4A	53.4A	72.2A	89.5A	115A
Engine Type	3-cylinder, 4-stroke, Water cooled	4-cylinder, 4-stroke, Water cooled	4-cylinder, 4-stroke, Water cooled	4-cylinder, 4-stroke, Turbo charged	4-cylinder, 4-stroke, Water cooled	4-cylinder, 4-stroke, Turbo charged	6-cylinder, 4-stroke, Water cooled	6-cylinder, 4-stroke, Water cooled
Fuel Tank	65ℓ	65ℓ	95ℓ	95ℓ	95ℓ	95ℓ	110ℓ	110ℓ
Displacement	1642cm³	2190cm³	2771cm³	2771cm³	4330cm³	4330cm³	6494cm³	6494cm³
Size (mm)	1570 x 780 x 1050	1570 x 780 x 1050	1900 x 950 x 1200	1900 x 950 x 1200	2250 x 950 x 1300	2250 x 950 x 1300	2700 x 1140 x 1500	2700 x 1140 x 1500
Dry weight	685kg	720kg	960kg	985kg	1270kg	1310kg	1650kg	1680kg
Noise Level (7m)	51dB	51dB	51dB	51dB	51dB	51dB	51dB	51dB
Included	Ammeter, Voltmeter, Frequency meter, Timer, Battery Voltmeter, Starting Failure Display, Charge Fault Display, Emergency Stop, AVR, Fuel Gauge, Circuit Breaker, Electronic Fuel Pump, ATS Interface and Battery.							
Protection	High water temp, Low oil pressure, over/under voltage, over/under frequency							

For AMF panels see page 299

DOMESTIC FLUSH SOCKETS & SWITCHES

NEW RANGE

Switch 16A @ 250VAC

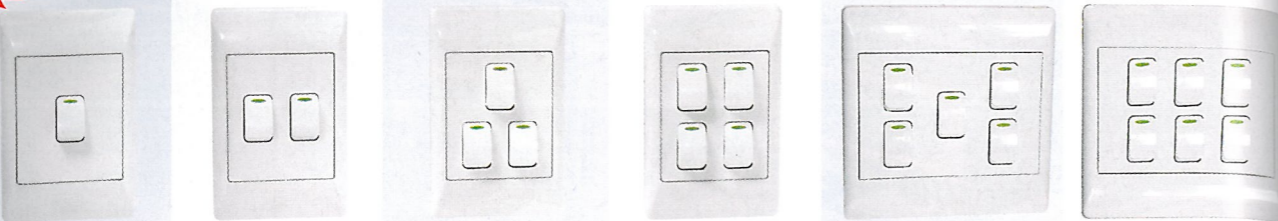

Code	A7001 1 lever 1 way	A7002 2 lever 1 way	A7003 3 lever 1 way	A7004 4 lever 1 way	A7005 5 lever 1 way	A7006 6 lever 1 way
Code	A7011 1 lever 2 way	A7012 2 lever 2 way	-	-	-	-

Standard Sockets

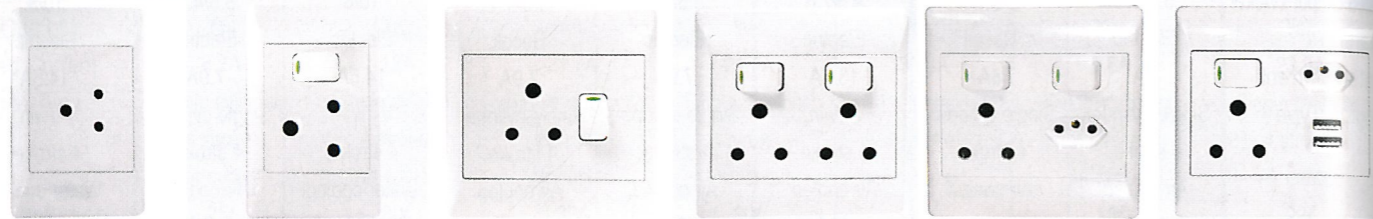

Code	A7008	A7400	A7401	A7402	A7403	A7404
Description	1 x 5A socket (4x2)	1 x 16A switched socket (4x2)	1 x 16A switched socket (4x4)	2 x 16A switched socket (4x4)	1 x 16A + 1 x 10A switched sockets	1 x 16A + 1 x 10A + 2x USB 5V, 500MA outputs

Dedicated Sockets

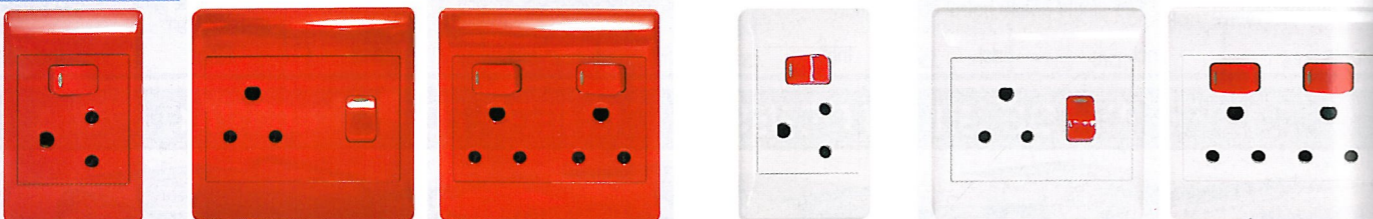

Code	A7500	A7501	A7502	A7500-W	A7501-W	A7502-W
Description	1 x 16A dedicated Red switched socket (4x2)	1 x 16A dedicated Red switched socket (4x4)	2 x 16A dedicated Red switched socket (4x4)	1 x 16A dedicated White switched socket (4x2)	1 x 16A dedicated White switched socket (4x4)	2 x 16A dedicated White switched socket (4x4)

Dimmers

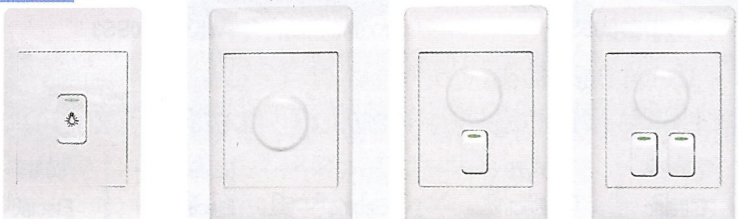

Code	A7033*	A7030	A7031	A7032
Description	*500W/ 800W Dimmer switch	500W Dimmer On/Off	500W Dimmer On/Off with 1 switch	500W Dimmer On/Off with 2 switches

Doorbell Switch



Code	A7007
Description	1 x 16A Spring return Doorbell Switch

Thermostat



Code	A7700
Description	Thermostat for underfloor heating 3600W c/w 20A Isolator and probe

Data

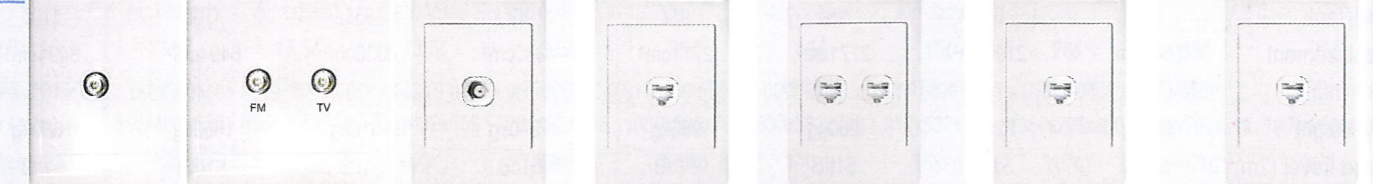

Code	A8040	A8041	A8042	A8043	A8044	A8045	A8046
Description	TV	TV & FM	SAT TV	RJ11/RJ12	2 x RJ11/RJ12	CAT 5E (RJ45)	CAT 6 (RJ45)

DOMESTIC FLUSH SOCKETS & SWITCHES

NEW RANGE



Code	A8048	A8047	A7100	A7102	A7103	A7104
Description	2 x CAT 6 (RJ45)	TV & Satellite	4 x 2 Blank Cover Plate	4x4 Blank Cover Plate	4 x 2 Surround	4 x 4 Surround

Isolators

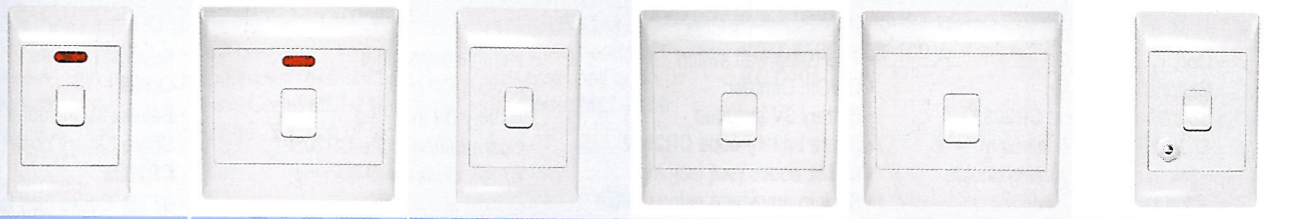

Code	A7300	A7301	A7302	A7304	A7303	A7305
Description	Stove Isolator 32A DP with neon (2x4)	Stove Isolator 45A DP with neon (4x4)	Stove Isolator 32A DP (2x4)	Stove Isolator 32A DP (4x4)	Stove Isolator 45A 3P (4x4)	Air-Conditioning Isolator 20A DP (4x2)

Accessories



Code	A700-SW	A701-SW	A702-SW	A702-BL	A700-SAT	A700-TV	A700-RJ12	A700-CAT5	A700-CAT6
Description	16A Switch 1 way	16A Switch 2 way	16A Pushbutton Spring Return	Blank Module	Satellite connection	TV connection	RJ12 Telephone Module	CAT 5E (RJ45) Module	CAT 6 (RJ45) Module

Classic Range

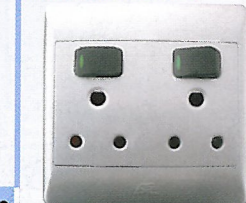

Full range available in silver colour + black switch add -S to end of code, e.g. A7402-S

Weatherproof Box c/w socket IP54

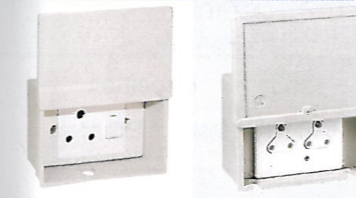

Code	A311S	A311D
Description	16A Single Socket	16A Double Socket

Blank Plates with holes to accommodate accessories

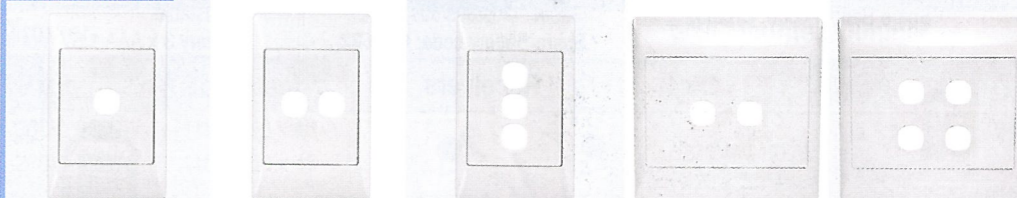

Code	A7105	A7106	A7107	A7108	A7109
Description	4 x 2 1 Way	4 x 2 2 Way	4 x 2 3 Way	4 x 4 2 Way	4 x 2 4 Way

Blister packed sockets and switches - Comes complete with extension box for surface mounting

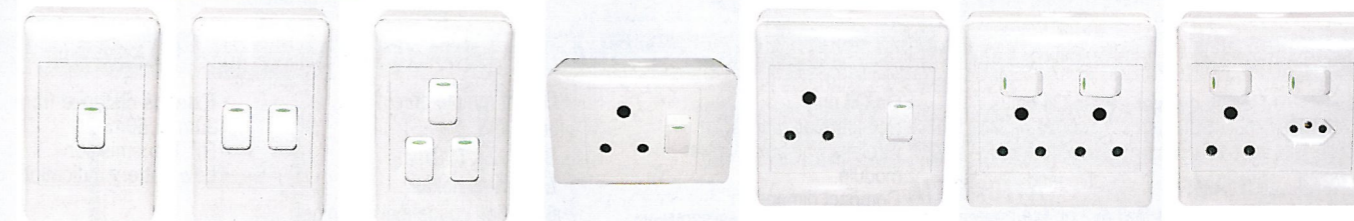

Code	A7001-BB	A7002-BB	A7003-BB	A7400-BB	A7401-BB	A7402-BB	A7403-BB
Description	1 Lever 1 Way light switch	2 Lever 1 Way light switch	3 Lever 1 Way light switch	1 x 16A switched socket (4 x 2)	1 x 16A Switched socket (4 x 4)	2 x 16A Switched Sockets (4x4)	1 x 16A + 1 x 10A Switched sockets



WIRELESS SWITCHES

NEW RANGE

New learning type switches

- Range 50 metres (line of sight)
- Blister packed for DIY
- Frequency 433.92 MHz
- 67 million codes (self learning)
- Battery life 12 months min

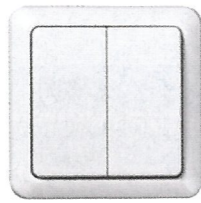
Transmitters





			
Code LWST-615	Code LWST-605	Code LYCT-505	Code LKCT-614
<ul style="list-style-type: none"> • On/Off, Dimmer • Battery 3V included • Spare battery code CR2032 • 67 Mil. Codes (self learning) • Stick in anywhere using double sided tape (incl) 	<ul style="list-style-type: none"> • Two Gang wall switch • On/Off, Dimmer • Battery 3V included • Spare battery code CR2032 • 67 Mil. codes (self learning) • Stick in anywhere using double sided tape (incl) 	<ul style="list-style-type: none"> • Remote transmitter • On/Off, Dimmer • Battery 3V included • Spare battery code CR2032 • 67 Mil. Codes (self learning) 	<ul style="list-style-type: none"> • Keychain remote • On/Off • Battery 3V included • Spare battery code CR2032 • 67 Mil. Codes (self learning)

			
Code LMST-606	Code LMDT-609	Code MDT-507	Code MDT-403
<ul style="list-style-type: none"> • Wireless magnetic door sensor transmitter • Time delay adjustable (0/2/4/8/10/20 minutes) • 67 mil. codes (self learning) • Battery 3V included • Spare Battery code: CR2032 	<ul style="list-style-type: none"> • Indoor PIR sensor • Detection distance adjustable (1~4M, 3~6M, 6~10M) • Angle Adjustable: H120, V45 degrees • Adjustable darkness level • Adjustable delay of time (10sec. /20s/30s/60s) • Spare Battery code: CR2032 	<ul style="list-style-type: none"> • Wireless PIR motion detector • PIR & CDS combination wireless detector transmitter • Detection capability: Distance up to 10M • Horizontal and vertical angle adjustable • Battery 3 x AAA 1.5V (not included) 	<ul style="list-style-type: none"> • Wireless PIR Movement Detector • Transmitter Range 25m • Detection Range 10m 110° angle • Battery 3 x AAA 1.5V (excluded) • Time on adj. 4 sec – 5 min • Compatible to receivers LCMR-1000 • LUX adjustable

Receivers

Repeater

Distance Extender

			
Code LCMR-300	Code LCMR-1000	Code LWMR-230	Code LBUR-100
<ul style="list-style-type: none"> • On/Off, dimmer • 300W (1.3A) min 40W resistive load • Fits into standard 4x2 or 4x4 boxes • Size: 53 x 53 x 28mm • Change your wall switch to wireless via remote control 	<ul style="list-style-type: none"> • On/Off only • 1000W (4.3A) min 40W resistive load • Compact dimension 42 x 42 x 13mm, Max 230Watts • 67 Million rolling codes setting before ex-factory • Change your wall switch to wireless via remote control 	<ul style="list-style-type: none"> • On/Off only • Self-learning function wireless wall box receiver module • Compact dimension 42 x 42 x 13mm, Max 230Watts • 67 Million rolling codes setting before ex-factory • Change your wall switch to wireless via remote control 	<ul style="list-style-type: none"> • On/Off remote control, max 60W • Size: 92 x 50mm • E27 Lamp holder • 67 million codes (self learning)
Code LEST-701	<ul style="list-style-type: none"> • Extends distance from 30m to 60m • RF Transmission • Low battery indication 		

WIRING ACCESSORIES

CODED WIRELESS SWITCHES

Plug-in Kit





NEW

Wireless Door Chimes

NEW

Wireless Transformer and Receiver

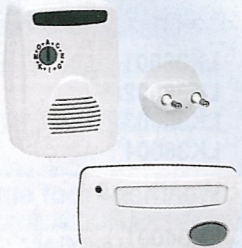
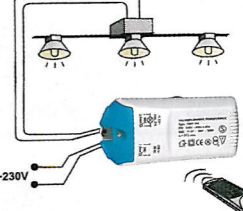
Transmitters

					
Code YC-1000	Code ML-8300	Code ML-7100	Code HDR-105	Code WST-8500	Code YCT-100
<ul style="list-style-type: none"> • 1 transmitter (YC-100) & 1 receiver (YCR-1000) packaging combination • YCR-1000 (receiver plug) equips ON/OFF remote switch function with max. load 1000W (5A) • Extending household electrical appliances to be remote controlled 	<ul style="list-style-type: none"> • Wireless combination door chime • Additional socket outlet on chime receiver offers multiple uses • Spare push bell button IP65. Code: MLT-7100 • Range 70m line of sight 	<ul style="list-style-type: none"> • Just plug and use • 2 pin Euro Plug • Range 70m line of sight • Flashing LED indicator for impaired hearing • Spare push bell button IP65. Code: MLT-7100 	<ul style="list-style-type: none"> • For 12V Halogen lamps 105W • On/Off, dimmer • Range 30m (line of sight) • Compatible to transmitters WST-8500, YCT-100 & KCT-101 	<ul style="list-style-type: none"> • On/Off, dimmer • Battery 12V incl. • Spare battery code WIR-12B • Coded, 16 Channels 	<ul style="list-style-type: none"> • On/Off • Battery 12V incl. • Spare battery code WIR-12B • Coded 16 channels

EXTENDED RANGE

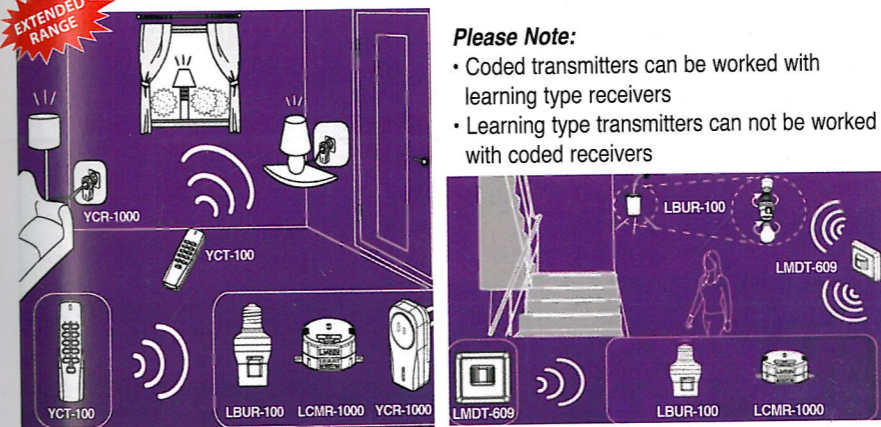

Coded Receivers

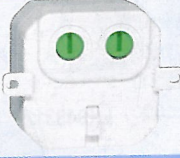
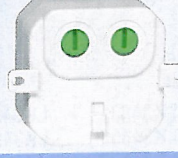

	
Code CMR-1000 On/Off *CMR-300 Dimming	Code JLR-1005
<ul style="list-style-type: none"> • 1000W (5A) resistive load • Fits into standard 4x2 or 4x4 boxes 	<ul style="list-style-type: none"> • Up/Down or Forward/Reverse • 1000W (5A) resistive load • Fits into standard 4x2 or 4x4 boxes
<p>(AC In) L $\frac{L}{N}$ $\frac{L}{N}$ N (AC In)</p> <p>AC out</p> <p>*300 Watt On/Off and dimming</p>	

DIMMERS & REMOTE CONTROLS

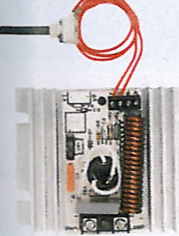
Industrial Dimmer

	Code RTS38	Rating 230V 3000W	Size (mm) 115 x 90 x 46
	Code RTS40	Rating 230V 5000W	Size (mm) 115 x 150 x 46
<ul style="list-style-type: none"> • CE Approved • 470kΩ Pot supplied • EMC Low Noise • Incandescent or Halogen Lamps 			

Wall Mounted Dimmer



	
Code Y-21052	Code Y-23052
<ul style="list-style-type: none"> • 230VAC/800W • 120 x 70mm • Fits standard 4" x 2" wall box • Not for Fluorescent lights • Y-23052 with extra 1 lever 1 pole switch 15A 	

Remote Dimmers (RF)

- On / Off and dimmer functions for incandescent lights
- On / Off function only for fluorescent lights
- 50m in line of sight, 433MHz • Rating: 230V 250W per channel
- Fits in standard 2 x 4 wall box

Teach-in

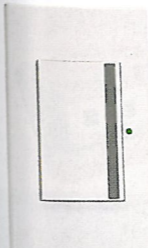
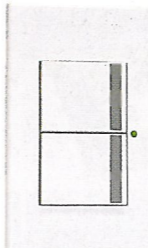
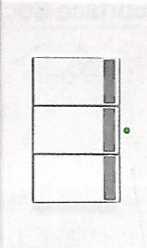
Replaces standard switches with no change to the wiring

			
Code MT-ZN011A	Code MT-ZN012A	Code MT-ZN013A	Code RM-01

Channels	Dimmer Only	*6 Channel Remote
1	MT-ZN011A	RM-01
2	MT-ZN012A	RM-01
3	MT-ZN013A	RM-01
Spare battery (not included)		WIR-12B

*Remote to be ordered separately

ENCLOSURES & SURFACE MOUNTING MODULAR COMPONENTS

NEW RANGE

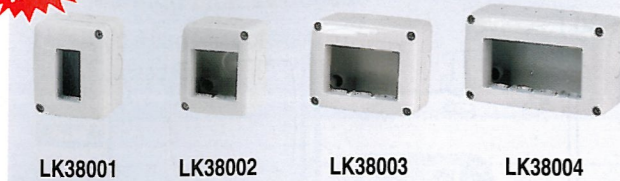

Indoor empty enclosures IP40

Code	Description	Size
LK38001	1 Way	66 x 82 x 55
LK38002	2 Way	66 x 82 x 55
LK38003	3 Way	99 x 82 x 55
LK38004	4 Way	132 x 82 x 55



Weather Proof empty enclosures IP55

Code	Description	Size
LK34001	1 Way	66 x 82 x 65
LK34002	2 Way	66 x 82 x 65
LK34003	3 Way	99 x 82 x 65
LK34004	4 Way	132 x 82 x 65



Enclosures complete with switches

Indoor IP40	Description	Weather Proof IP55
LK38801	16A 1P 1 lever	LK34831
LK38832	16A 1P 2 lever	LK34525
LK38835	16A two-way 1 lever	LK34832
LK38832	16A two-way 2 lever	LK34526
LK38835	16A N/O pushbutton 1 lever	LK34835
LK38853	British 13A switched socket	LK34853
LK38844	German 16A Schuko socket	LK34844
LK383312	RSA 15A Switched socket	LK343312



Switches and Sockets for use in Empty Enclosures

Code LK30571	Code LK30573	Code LK30513	Code LK30201	Code LK30212	Code LK30265	Code LK30208	Code LK30209
16A 1Way Switch	16A 2Way Switch	16A N/O Push Button	10A Euro Socket	16A Euro-American Socket	16A Schuko Socket	13A British Socket	15A South African Socket

INDUSTRIAL SURFACE SOCKETS & SWITCHES

Code A701	Code A703	Code A704	Code A706	Code A707	Code A708	
16A Socket with On/Off	2 x 16A with On/Off	1 Lever 1 Way (10A) 1 Lever 2 Way (10A)	2 Lever 1 Way (10A)	3 Lever 1 Way (10A)	16A Socket with On/Off	

Industrial Surface Sockets

Code A3027 (20A) A711 (45A)	Code A712	Code A702	Code A7600B Brass A7600C Chrome	Code A7601B Brass A7601C Chrome	Code A7602B Brass A7602C Chrome
DP 250V Isolator	45A DP 250V Isolator with 230V Pilot Light	5A Socket	16A Switched Socket Outlet	Double Telephone Socket RJ12	RJ12 and CAT6

TRAVEL ADAPTORS

S.A Travel Adaptor



SAT100
15A South African to multi-adaptor

Travel Adaptors



YX1190
2 Pin Euro / American to British, Australian, Euro or American

British Travel Adaptors



BE-822
13A British to Multi-adaptors & to South African

Multi-Adaptor (with USB 500mA 5V output)



RW-SM
Input multi-plug; can be configured as British, American, Australian and Euro. Output: multi-plug output + USB power output

EXTENSION CORDS AND REELS

- 16A 1.5mm² x 3 Core Cable
- 10A 1.0mm² x 3 Core Cable



Length	Code with 2 Sockets side by side (white)		Length	10A	16A
	10A	16A			
3M	A1-3W	A2-3W	10M	SX10-10M	SX16-10M
5M	A1-5W	A2-5W	20M	SX10-20M	SX16-20M
10M	A1-10W	A2-10W	25M	SX10-25M	-
15M	A1-15W	A2-15W			
20M	A1-20W	A2-20W			
25M	A1-25W	A2-25W			



Length	Code		16A Plug with 2m cord, open ended on opposite side	5A Plug with 2m cord, open ended on opposite side
	10A	16A		
15m	XM-1015	XM-1615		
20m	XM-1020	XM-1620		
25m	XM-1025	XM-1625		
30m	-	XM-1630		
50m	-	XM-1650		

• Double Socket outlets • 16A 1.5mm² x 3 Core Cable
• Double 2 Pin Euro 16A/10A Socket outlet • 10A 1.0mm² x 3 Core Cable
• PVC reel, c/w cable and plug

Other Cables

Type	Cable Colour	Code *6A 1.8m *16A 0.8m		Code 2 Way *10A		Code 3 Way *10A		Code *6A *10A	
		A303G	A313G	A802G	A803G	A504G	A514G		
Standard	Grey	A303G	A313G	A802G	A803G	A504G	A514G		
	Black	A303BK	A313BK	A802BK	A803BK	A504BK	A514BK		
Dedicated	Black	D303BK	D313BK	D802BK	D803BK	-	-		
British	Black	B303BK	B313BK	-	-	-	-		

*Ratings are based on the rating of the cable

SCHUKO SOCKET & PLUG

Code KFB-602201	Code KFB-602202	Code KFB-54950	Code KFB-3006OR	Code KFB-3007OR	Code KFBG-15
10/16A Plug	10/16A Socket	10/16A 2P+E Socket	25m Extension Cord (10A) (OR) Orange	15m Extension Reel (16A)	

NEW

3 X 3 SOCKETS AND SWITCHES

Single Lever SP Switch 10A	Single Lever DP Switch 10A	Intermediate Switch 10A	2-Way Switch 10A	Push Button 10A	2-Lever Switch 10A	2-Lever 2-Way Switch 10A	3-Lever Switch 10A
EF90011C	EF90021C	EF90051C	EF90071C	EF90151C	EF90061C	EF90101C	EF90088C
Push-Button + 2-Way Switch 10A	Card Switch 10A	Pull Cord Switch 10A	Dimmer Switch (500W)	Electronic Dimmer Switch (320W)	Motion Detector	TV/ Satellite Socket	Euro/ USA Earth Socket 16A
EF90159C	EF90031C	EF90092C	EF90211C	EF90212C	EF90401C (1000W)	EF90560	EF90142C
French Earth Socket 16A	Schuko Earth Socket 16A	RJ45 CAT5e Computer Socket	RJ45 CAT6 Computer Socket	RJ11 (4-Pin) Telephone Socket	RJ12 (6-Pin) Telephone Socket	Surface Mounting Box	Surface Socket 16A
EF90111C	EF90632C	EF90453C	EF90455C	EF90252C	EF90253C	EF10976A	EF37131C
Flush Mounting Boxes	Spacer	Double Frame	Triple Frame	4-Gang Frame	5-Gang Frame		
BEL-B1	EF24232	EF24233	EF90920T	EF90930T	EF90940T		EF90950T

FLUSH FLOOR SOCKET BOXES

NEW



Underfloor Vanish Socket Boxes		
Code	Description	Size L x W x D
SPF08	Socket box accommodating 2 x support frames	340 x 220 x 102
SPF16	Socket box accommodating 4 x support frames	340 x 375 x 102
S08BOX	Galvanised box for installation of SPF08 into concrete slab	310 x 236 x 103
S16BOX	Galvanised box for installation of SPF16 into concrete slab	310 x 388 x 103

Features

- Reversible lid can be fitted with your choice of floor covering or used as is.
- Cable exits are specially designed to protect cables.
- Cover is easily removable to improve access for installation and maintenance.

Support Frames

SMP43	Support frame for 4-modules (with reduction piece for 3-modules) [†]
SMP45	Support frame for three 45 x 45mm modules*
SMP11	Support frame for 2 modules of DIN Mount devices (circuit breakers, timers)

[†] Can be used with GEWISS range, pages 384-396 or ACDC 2 x 4 range, pages 302 & 303.
* For 45 x 45 devices, see page 311.

NEW RANGE

CABLE ACCESSORIES

Half Round Trunking Grey - Single compartment	Half Round Trunking Grey - 4 Compartment	Bi-Facial Floor-Mount Turret - For use on raised floors or in conjunction with half round trunking
Supplied in 1m lengths	Supplied in 2m lengths	
Code	Size W₁ x W₂ x H₁ x H₂	Code
RTD-40D	40 x 19 x 11 x 8.5	KP1873.1
RTD-60D	60 x 33 x 15 x 12	
RTD-90D	90 x 54 x 22 x 17.5	
RTD-120D	120 x 83 x 30 x 25	
		Derivation Box for Half Round Trunking
		Code
		KPD.1
		Size W x B x H
		100 x 100 x 30

NEW RANGE

OFFICE POLES

Single Face Office Poles with Telescopic Mounting	Office Poles with Telescopic Mounting
<ul style="list-style-type: none"> Use AC/DC switch /socket range page 302 Use Gewiss range of switches/sockets page 384 - 396 	<ul style="list-style-type: none"> For switches/sockets, see pages 302, 384, 396.
Accessories	Accessories
CF503AA 3 Module Support frame	B080.2 Spare 2m length of cover
CF504AA 4 Module Support frame	BS80-53.2 PVC support frame for 3/4/6 modules
CF506AA 6 Module Support frame	BS686 Socket Box for 3/4/6 modules
Code	Code
CM280310AA	S/S CB1333 D/S 129336VA
Construction	Anodised Aluminium
Kit includes:	<ul style="list-style-type: none"> 2 x BS686 socket boxes for 3/ 4/ 6 modules, 2 x support frames for 3 modules
	<ul style="list-style-type: none"> 2 x support frames for 3/ 4/ 6 modules 2 x support frames for 3/ 4/ 6 modules 4 x BS686 socket boxes for 3/ 4/ 6 modules, 4 x support frames for 3/ 4/ 6 modules
	Painted aluminium with black PVC covers Single sided 10.5cm(W) x 6.5cm(D) x Height 2.7m - 3.3m Double sided 11.5cm(W) x 12cm(D) x Height 2.7m - 3.3m
	Code
	M103 M102-2
Construction	Anodised Aluminium and Black Plastic
Power Outlets	3 x 16A outlets 2 x 16A outlets
Data	- 2 x RJ45 CAT6 outlets
	Floor Mounting Mini Office Poles
	<ul style="list-style-type: none"> For switches/ sockets, see pages 302, 384, 396.
	Painted aluminium with black PVC covers Single sided 10.5cm(W) x 6.5cm(D) Double sided 11.5cm(W) x 12cm(D)
	Code
	S/S CDP30 D/S 12932VA CDP50 12954VA CDP70 12976VA
	<ul style="list-style-type: none"> 2 x BS686 socket boxes for 3/ 4/ 6 modules, 2 x support frames for 3/ 4/ 6 modules For CDP30 only 1x BS686 and 1 support
	<ul style="list-style-type: none"> 2 x support frames for 3/ 4/ 6 modules, 2 x BS686 socket boxes for 3/ 4/ 6 modules, 4 x BS686 socket boxes for 3/ 4/ 6 modules,
	<ul style="list-style-type: none"> 2 x support frames for 3/ 4/ 6 modules 4 x support frames for 3/ 4/ 6 modules

WIRING ACCESSORIES

WIRING ACCESSORIES

ALUMINIUM POWER SKIRTING

NEW RANGE

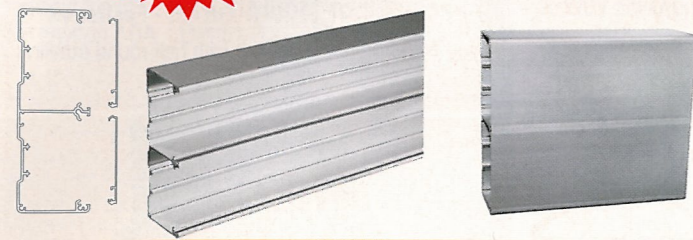

Aluminium Power Skirting - 180 x 65mm Finish: Natural Anodised

Code	Description	Length	Ctn Qty
BU651808-2A	Trunking	2m	4
BO80A	Aluminium Trunking Cover	2m	12
BO80.2	Black PVC Cover	2m	12

(NB: Trunking Cover to be ordered separately)

Routing Components for 180 x 65mm Trunking

Code	Description	Ctn Qty
GTR60-1	1m length Divider	50
BE1808.4	End Caps	5
BI1808A	Internal Angle	1
BA1808A	External Angle	1
BAO80A	Cover for External Angle	1
BW1808A	Plane Angle	1
BWO80A	Cover for Plane Angle	1
BT1808A	T-Piece	1

Aluminium Power Skirting - 105 x 65mm Finish: Natural Anodised

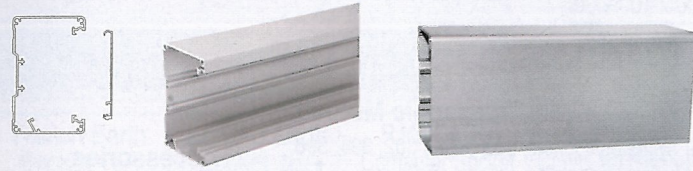

Code	Description	Length	Ctn Qty
BU651058A	Trunking	2m	4
BO80A	Aluminium Trunking Cover	2m	12
BO80.2	Black PVC Cover	2m	12

(NB: Trunking Cover to be ordered separately)

Routing Components for 105 x 65mm Trunking

Code	Description	Ctn Qty
GTR60-1	1m length Divider	50
BE1058.4	End Caps	5
BI1058A	Internal Angle	1
BA1058A	External Angle	1
BAO80A	Cover for External Angle	1
BW1058A	Plane Angle	1
BWO80A	Cover for Plane Angle	1
BT1058A	T-Piece	1

Accessories for Aluminium Power Skirting 180x65 & 105x65

Code	Description	Ctn Qty
BS683	Socket Box 3 Modules	10
BS686	Socket Box 3-4-6 Modules	12
BS80-53A	Socket Point Cover 3 Module	10
BS80-54A	Socket Point Cover 4 Module	10
BS80-56A	Socket Point Cover 6 Module	10
BSZ65	Pack of 4 Alignment Pins	10 packs
BSV080.4	Joint Cover	10

Code	Description	Ctn Qty
EF10971	Adaptor for 4 x 2 Sockets	10
A7400	1 x 16A RSA Socket	10
A7500	1 x 16A Dedicated RSA Socket	10
A7500-W	1 x 16A Dedicated RSA Socket	10

Code	Description	Ctn Qty
GW16203VA	3 Gang Cover Plate	
GW16803	3 Gang Support Plate	
GW12001	1P 16A Switch	
GW12423	CAT6 RJ45	
GW12241	2P+E 16A Schuko	
GW12297	2P+E 15A SA Outlet	
GW12287	2P+E 10/15A Euro/ American	
GW12457	USB Connector	

For full range of GEWISS sockets and switches see page 388-396

PVC POWER SKIRTING

NEW RANGE

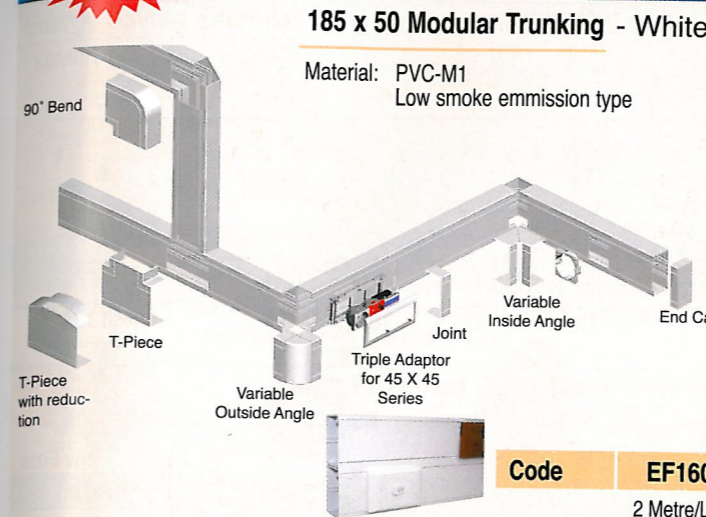

185 x 50 Modular Trunking - White

Material: PVC-M1
Low smoke emission type

110 x 50 Modular Trunking - White

Material: PVC-M1
Low smoke emission type

Code	Description	Ctn Qty
EF16040	185 x 50 Modular Trunking	4 (2 Metre/Length)
EF10090	110 x 50 Modular Trunking	10 (2 Metre/Length)

Routing Components for trunking 185 x 50

Code	Description	Ctn Qty
EF16041	T-Piece	5
EF16042	Inside Angle	5
EF16043	Plane Angle	5
EF16044	Joint	5
EF16045	End Cap	5
EF16046	Outside Angle	5
EF10987	Cable Support	50
EF10099	Internal Divider/12m	20m (10 Length)
EF16971	Adaptor Clip	48m (24 Length)

Routing Components for trunking 110 x 50

Code	Description	Ctn Qty
EF10091	T-Piece	4
EF10092	Variable Inside Angle	4
EF10093	90° Bend	4
EF10094	Joint	4
EF10095	End Cap	4
EF10096	Variable Outside Angle	4
EF10098	T-Piece with reduction	4

COMPONENTS FOR TRUNKING 185 x 50 AND 110 x 50

Code	Description	Ctn Qty
EF10986	2 Gang Adaptor c/w plate	20
EF10952	4 Gang Adaptor c/w Plate	10
EF10954	6 Gang Adaptor c/w Plate	10
EF45142S	2 Gang Euro & USA Socket	10
EF45132S	Schuko 16A - 250V (2G)	10
EF45136S	16A Schuko Protected (2G)	10
EF45138C	Single Schuko c/w cover	10
EF45262C	Dual Schuko c/w cover	10

Code	Description	Ctn Qty
EF45972S	RJ11 1 Gang	5
EF45975S	CAT5e RJ45 UTP 1Gang	5
EF45978S	CAT6 RJ45 UTP 1 Gang	5
EF45988S	CAT6 RJ45 FTP 1 Gang	5
EF45974S	Fibre Optic Connector (ST)	5
EF45970S	Blanking Plate	5
EF45531S	R-TV Socket Terminal Type	10
EF45550S	R-TV Socket Satellite	10

Code	Description	Ctn Qty
EF10971	Adaptor for 4 x 2 Sockets	10
A7400	1 x 16A RSA Socket	10
A7500	1 x 16A Dedicated RSA Socket	10
A7500-W	1 x 16A Dedicated RSA Socket	10

PLUG TOPS, SOCKETS & ADAPTORS

Euro Adaptors (comply to VC8008)

FULL NEW RANGE

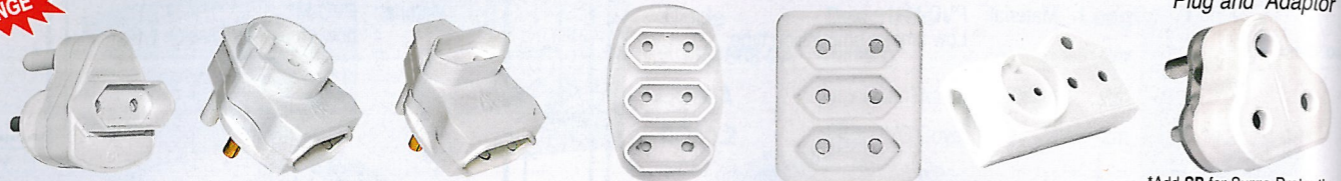

Code	A411	A412	A413	A414	A416	SK250097	AP4026*
------	------	------	------	------	------	----------	---------

Plugs	Standard 16A	Rubber 16A	5A	Dedicated 16A	16A Hollow Pins	British 13A	
-------	--------------	------------	----	---------------	-----------------	-------------	--

*Add colour to code:
 ○ WH white, ● BK black
 ● BL blue, ● Y yellow,
 ● GN green, ● OR orange



Code	A300-*	RA300BK	A301	A303	4036	A304
------	--------	---------	------	------	------	------

Adaptors **NEW**

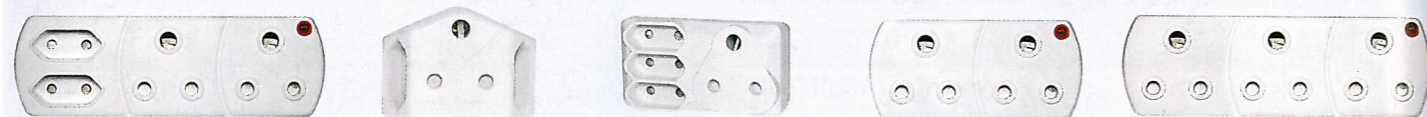

Code	AP302	AP303	AP304	AP305	AP306
------	-------	-------	-------	-------	-------

Janus Adaptors **NEW**



Code	A310W	A310BK	RA310BK
------	-------	--------	---------

16A Sockets



Code	A307	ED308
------	------	-------

Test report 794/41153



Code	A308
------	------

5A Socket **NEW**



Code	A309
------	------

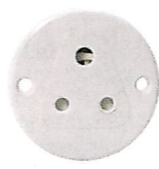

Code	A322
------	------

Extenders

Standard White Extenders



Code	A312	A313	A315
2 x 16A extension with overload protection, c/w 400mm cord.	3 x 16A extension with overload protection, c/w 400mm cord.	5 x 16A extension with overload protection, c/w 400mm cord.	

Test Report HC/100728A

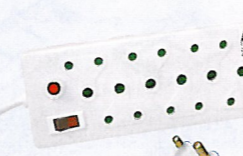

Code	YD-6NS
------	--------

Test Report HC/100728B

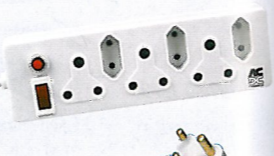

Code	YD-6N2S
------	---------

With On/Off switch and circuit breaker for overload protection, c/w 0.5 metre cable.
 *Complete with surge protection

16A Dedicated Red Extenders

Test report ML/104064



Code	ED512	ED513	ED515
2 x 16A extension with overload protection, c/w 400mm cord.	3 x 16A extension with overload protection, c/w 400mm cord.	5 x 16A extension with overload protection, c/w 400mm cord.	

Complies to IEC 61000-4



Code	YD-3NS
------	--------

With 6 x 16A RSA sockets and 4 x 2PIN Euro Sockets.

Includes On/Off switch and overload protection. Plug-in surge protection SP4001 to be ordered separately.

S.A. EXTENDERS

Energy Saving Extender

Test report ML/104701

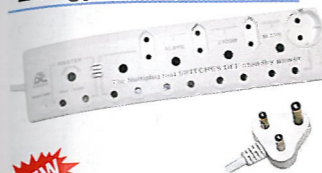

Code	AP5041
------	--------

Plug TV/PC into master socket. All peripheral equipment is plugged into slave. Supply for the slave is switched in conjunction with master being switched on or off. 0.5 metre cable.



Code	AP5041-SP
------	-----------

With surge protection

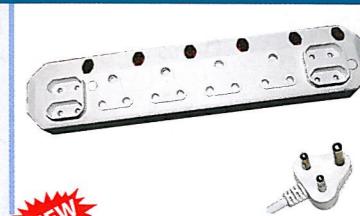

Code	A4X4
------	------

With On/Off switches and circuit breaker for overload. 0.5 metre cable



Code	AP4034
------	--------

With On/Off switch and circuit breaker for overload. 0.5 metre cable

NEW

Surge Protected Extenders RCC No: ML/103159E, ML/103159A, ML/103294, ML/103493F, ML/1034932B



Code	YDA4W
------	-------

• 4 Way adaptor
 • 2 x 15A + 2 x 2Pin Euro sockets
 • Power on indicator light



Code	YDS4WS
------	--------

• 4 Way adaptor
 • 1 x 15A + 2 x 2Pin Euro + 1 x Schuko socket
 • Power on indicator light



Code	YD8WRJ
------	--------

• 13 Way multi-plug
 • 4 x 15A + 3 x 2Pin Euro + 1 x Schuko
 • 1x Telephone input + 2 x Outputs
 • 1 x Data input + 1 x output
 • Reset switch for overload protection
 • c/w overload protection
 • 0.5 metre cable



Code	SMP8WSW
------	---------

• 8 Way premium extender
 • Illuminated master switch
 • 4 x 15A + 3 x 2Pin Euro + 1 x Schuko socket
 • c/w overload protection
 • 0.5 metre cable



Code	SMP12WSW
------	----------

• 12 Way premium extender
 • Illuminated master switch
 • 6 x 15A + 5 x 2Pin Euro + 1 x Schuko socket
 • c/w overload protection
 • 0.5 metre cable

NEW

EXTENDERS EURO & BRITISH TYPE



Code	TDZ-6B
6 x 2 Pin Euro Sockets	



Code	KFB-03/4
4 x 2 Pin Euro & 3 x Schuko Sockets with Schuko Plug	



Code	C1-H3T
3 x Schuko Sockets	



Code	C1-H4T
4 x Schuko Sockets	

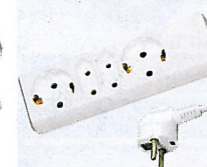

Code	C1-2P
2 x Schuko & 2 x 2-pin Euro Sockets	

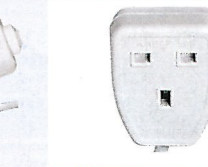

Code	L-12
13A British Single Janus Plug	

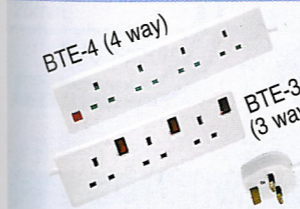

Code	BTE-3
13A British Sockets	
Code	BTE-3-SP
With Surge Protection	



Code	BTE-4
On/Off switches	
Code	BTE-4-SP
With Surge Protection	

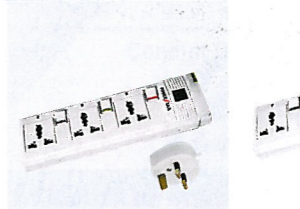

Code	BTE-5
On/Off switches	
Code	BTE-5-SP
With Surge Protection	

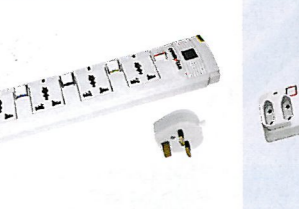

Code	L-31-3
3-Way Multi-adaptor Extender	

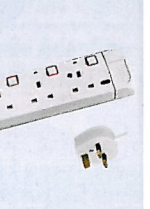

Code	L-30
5-Way Multi-adaptor Extender	

Code	BTE-4X2
2 x 2 Pin Euro & 3 x 13A British c/w On/Off switches	

Extension Cords



10A 1mm² x 3 core

Length	Code	
	White	Black
3m	B2-3W	B2-3B
5m	B2-5W	B2-5B
10m	B2-10W	B2-10B
20m	B2-20W	B2-20B

Extender Reels

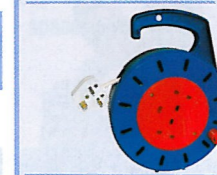

Length	10m
Code	BE-10M

Metal Clad Sockets

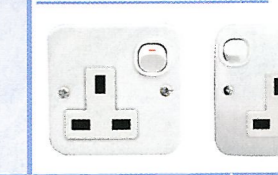

Code	A709	A710
13A British Socket Outlet	2 x 13A British Socket Outlets	

STEEL CONDUIT FITTINGS & ACCESSORIES

NEW RANGE

	Galvanised Conduit Push-in Type	1-Way Conduit Box Push-in Type	2-Way Conduit Box Push-in Type	Angle Conduit Box Push-in Type	3-Way Conduit Box Push-in Type
	Wall Thickness: 1.6mm Supplied in: 3m length				
20mm	ST-CON-20	M181-20	M182-20	M183-20	M184-20
25mm	ST-CON-25	M181-25	M182-25	M183-25	M184-25

	Threaded Rods Zinc Plated	Open Channel - 3m	Slotted Channel - 3m	M8 x 25mm Bolt	Spring Nuts (M8)
	Supplied in 1m threaded lengths	Supplied in 3m lengths		100 Per pack	100 Per pack
6mm	THR-M6	41 x 21mm PC-41X21	SC-41X21	MV66133/100	MV66152 for 21mm channel
8mm	THR-M8	41 x 41mm PC-41X41	SC-41X41	-	MV66157 for 41mm channel

	Male Hook	Hook, Dome, Combined, Steel Lid	Female, Dome, Steel Lid	Loop-In Box	Overlapping Lid	Standard Lid
20mm	M502-20	R287	M288	R274	R280	R281
25mm	M502-25	-	-	4 Hole	-	-

	Coupling	Nipple	Female Threaded Adaptor	Male Threaded Adaptor	90° Bend
20mm	R101-20	F107-20	FTA-20	MTA-20	FB-20
25mm	R101-25	F107-25	FTA-25	MTA-25	FB-25

	Inspection Elbow Threaded	Inspection Tee Threaded	Brass Male Bush	Brass Female Bush	Lock Nuts
20mm	M145-20	M133-20	BMB-20/100 or /10 9mm	BFB-20/100 or /10	LN-20/100 or /10
25mm	M145-25	M133-25	BMB-25/100 or /10 11mm	BFB-25/100 or /10	LN-25/100 or /10
32mm	-	-	BMB-32/50 or /5 11mm	BFB-32/50 or /10	LN-32/50 or /10

Only available in full packs as indicated by part no /...

CONDUIT ACCESSORIES

PVC Conduit (4m length)			Locking Adaptors	Couplings	90° Bends
	Bundle	Qty	M		
20mm	CON-20/25	25	100	CA-LA20/50	CA-C20/50
25mm	CON-25/25	25	100	CA-LA25/50	CA-C25/50
32mm	CON-32/10	10	40	CA-LA32/20	CA-C32/20
40mm	CON-40/10	10	40	CA-LA40/20	CA-C40/20
50mm	CON-50/10	10	40	CA-LA50/10	CA-C50/10

	1-Way Conduit Box	2-Way Conduit Box	Angle Conduit Box	3-Way Conduit Box	4-Way Conduit Box	1-Way Back Entry Loop-in Box
20mm	CA-1W-20/20	CA-2W-20/20	CA-2V-20/20	CA-3W-20/20	CA-4W-20/20	CA-1BW/20
25mm	CA-1W-25/20	CA-2W-25/20	CA-2V-25/20	CA-3W-25/20	CA-4W-25/20	-

	2-Way Back Entry Loop-in Box	3-Way Back Entry Loop-in Box	4-Way Back Entry Loop-in Box	Inspection Tee piece	Inspection Elbow	Inspection Bend
20mm	CA-2BW/20	CA-3BW/20	CA-4BW/20	CA-IT/20	CA-IE/20	CA-IB/20
25mm	-	-	-	-	CA-IE/25	-

	"U" Conduit Box	"Y" Conduit Box	Side & Back Loop-in Box	Back only Loop-in Box	Standard Lid	Standard Elbow	NEW M4 Screw
20mm	CA-2U/20	CA-3Y/20	CA-B1-8/20	CA-B2/20	CA-L1/50	CA-PL20/20	M4/100
25mm	-	-	(8 hole)	4 Hole	without screws	CA-PL25/20	Size: M4 x 8mm

	PVC Saddles	PVC Saddles c/w spacer bar & screws	PVC Conduit Clamp	Conduit Clamp c/w Screw	Female Adaptors	Female Adaptors Double Bush
20mm	CA-S20/1000 or /100	CA-SB20/200 or /20	CL-20/100 or /20	CL-20W/N/100 or /20	CA-FA20/50	CA-FAD-20/50
25mm	CA-S25/500 or /50	CA-SB25/200 or /20	CL-25/100 or /20	CL-25W/N/100 or /20	CA-FA25/50	CA-FAD-25/50
32mm	CA-S32/100 or /10	-	-	-	CA-FA32/50	CA-FAD-32/50

	Galvanised Steel Saddles	Galvanised Half Steel Saddles	Galv. Steel Saddles c/w spacer bar & screws	Galv. Steel Saddles c/w spacer bar & screws	Bending Spring	PVC Glue
20mm	GS-20/100 or /10	GFS-20/100 or /10	GSB-20/100 or /10	GSB1-20/50 or /10	CA-SP20/1	200ml PVC-GLUE2/1
25mm	GS-25/100 or /10	GFS-25/100 or /10	GSB-25/100 or /10	GSB1-25/50 or /10	CA-SP25/1	100ml PVC-GLUE1/1

WIRING ACCESSORIES

WIRING ACCESSORIES

LOW VOLTAGE LIGHT BOXES & CONDUIT ACCESSORIES

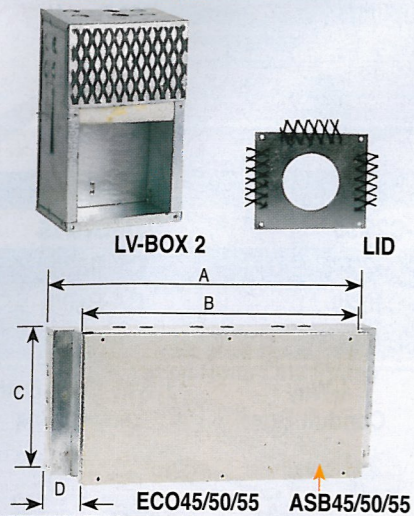

Low Voltage light boxes and lids

Code	Description	Dimensions H x W x D
LV-BOX 1	For Low Voltage Light Box	210 x 150 x 130
LID-*	*Add lid with hole size: 65, 75, 85mm. Please specify	
LV-BOX 2	For Low Voltage Light Box	250 x 150 x 130
SABLID-*	*Add lid with hole size: 65, 75, 85mm. Please specify	
* Conforms to specification IEC/SABS 60598-1 and IEC/SABS 60598-2-2		
* Fitted with fibre heat resistant barrier		
Code	Description	Dimensions A x B x C x D
ECO45	Galvanised Eco slab box	450 x 400 x 220 x 115
ECO50	Galvanised Eco slab box	500 x 450 x 220 x 115
ECO55	Galvanised Eco slab box	550 x 500 x 220 x 115
ASB45	Asbestos Eco lid	390 x 220
ASB50	Asbestos Eco lid	440 x 220
ASB55	Asbestos Eco lid	490 x 220

Draw Boxes Galvanised

Code	Size (H x W x D)
GDB62	150 x 150 x 50
GDB63	150 x 150 x 75
GDB92	230 x 230 x 50
GDB93	230 x 230 x 75
GDB122	305 x 305 x 50
GDB123	305 x 305 x 75

Screws for Wallboxes per 50

Code	Description
SC4X40	4mm x 40mm screw with counter sunk head
SC4X75	4mm x 75mm screw with counter sunk head

Wall Boxes 4 x 2

Flush			Surface Ext. Boxes		
Code	Material	Size mm	Code	Material	Size mm
TM-2020	Steel	105.5 x 61 x 50(D)	EB42	Steel - open back	50 x 100mm
TM-42S	Steel	105 x 65 x 45(D)	EB42C	Steel - closed back	50 x 100mm
TC-PR42	Plastic	105 x 61 x 50(D)	PEB42	Plastic	50 x 100mm

Wall Boxes 3 x 3 (75x75mm)

Flush Box		Surface Box	
Code	Size mm	Code	Size mm
BEL-B1	75 x 75 x 37mm	BEL-B2	86 x 86 x 30mm

Wall Boxes 4 x 4

Flush				Surface Ext. Boxes		
Code	Material	Size mm	Code	Material	Size mm	
TM-4040	Steel	105.5 x 105.5 x 50(D)	EB44	Steel - open back	100 x 100mm	
TM-44S	Steel	105 x 105 x 45(D)	EB44C	Steel - closed back	100 x 100mm	
TC-PR44	Plastic	105 x 105 x 50(D)	PEB44	Plastic	100 x 100mm	
TC-PR22X44	Plastic	205 x 95 x 42(D)				

FISH TAPE

Nylon Fish Tape, Nylon 6/6

Breaking load	Code	Length	Dia
160kg	NFT-2403	15 metres	4mm
160kg	NFT-2406	30 metres	4mm
	NFT-2950	50 metres	6mm
	*NFT-2951	100 metres	6mm

*Complete with Reel

Accessories

Code	Description
NFT-2911	Pulling Head for 6mm Fish Tape
NFT-2916	Pulling Clamp for 6mm Fish Tape
NFT-2918	Brush for 6mm Fish Tape

Steel Fish Tape

Code	Length
FT-30M	30m

0142 Authorisation Cert. No. 0209036 (for armoured glands)

CABLE ACCESSORIES

Size	Hole Size	Glands			Throat Ø	Earth Rings for Cable Glands	Compression Glands		Claw/Rubber Compression	Steel Gland Rubber Compression
		Gland	PVC Shroud	Rubber Shroud			White	Black		
10	16mm	-	-	-	-	-	-	MGB16-10*	SCG-00	
10	20mm	-	-	-	-	-	CG-00	CG-00-B	-	
10	20mm	ACG-0	ACS-0	RUS-0	14.7mm	ACG-20-TAG	CG-0	CG-0-B	MGB20-14*	SCG-0
1	20mm	ACG-1	ACS-1	RUS-1	18.7mm	-	CG-1	CG-1-B	-	SCG-1
2	25mm	ACG-2	ACS-2	RUS-2	24.4mm	ACG-25-TAG	CG-2	CG-2-B	MGB25-18G	SCG-2
3	32mm	ACG-3	ACS-3	RUS-3	30.0mm	ACG-32-TAG	-	-	MGB32-25G	SCG-3
4	40mm	ACG-4	ACS-4	RUS-4	39.5mm	-	-	-	MGB40G	SCG-4
5	50mm	ACG-5	ACS-5	RUS-5	49.0mm	-	-	-	MGB50G	SCG-5
6	63mm	ACG-6	ACS-6	RUS-6	62.2mm	-	-	-	-	SCG-6
7	78mm	ACG-7	ACS-7	RUS-7	74.0mm	-	-	-	-	SCG-6

*Add colour to code: G(Grey), BK(Black)
NOTE: For Flameproof Glands, see page 257.

Compression Glands Fitting To Conduit Boxes

Code	Size	Throat Size	For Conduit Box
CAG-0	0	8mm (Blue grommet)	20mm
CAG-1	1	11mm (Red grommet)	20mm

EX Cable Glands Explosive Areas

IP68 5 Bar with strain relief black Polyamide Group II Category 2GD, ATEX1087X

Code	Size	Cable Size Ø
124M20EX03	M20	6-12mm
124M25EX03	M25	13-18mm
124M32EX03	M32	18-25mm

For other Flameproof Glands - see page 257

PG COMPRESSION GLANDS IP65

Code	PG Size	Mounting Hole	Cable Ø	Code	PG Size	Mounting Hole	Cable Ø
PG-7	7	12.5mm	3-6mm	PG-21	21	29mm	13-18mm
PG-9	9	16mm	5-8mm	PG-29	29	37mm	20-25mm
PG-11	11	19mm	6-10mm	PG-36	36	48mm	28-33mm
PG-13.5	13.5	20mm	7-12.5mm	PG-42	42	54mm	33-38mm
PG-16	16	23mm	9-14mm	PG-48	48	60mm	40-45mm

STRAIN RELIEF BUSHINGS

Code	Cable Dimensions (mm)	Panel Thickness (mm)	Mounting Holes	
			H	W
For Flat Cable				
SB2F-1	2.8 x 5.3	0.5 x 1.7	9.5	8.7
SB3F-1	3 x 5.6	0.7 x 1.8	11	9.9
SB41-1	3.8 x 7.1	0.5 x 1.6	12.7	11.8
For Round Cable				
SBR5-1	6.20 to 4.40	0.5 to 1.8	12.7	11.5
SB6N-4	7.40 to 8.20	0.5 to 1.8	15.9	14
SB7R-1	8.20 to 9.20	0.5 to 1.8	15.9	14
SB8R-1	9.20 to 10.50	0.5 to 1.8	19	16.5

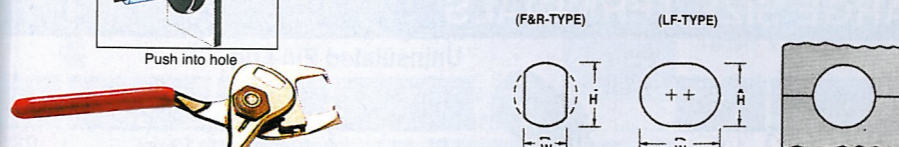

Strain Relief Bushing Tool

Code	Description
SF35-030	Strain relief bushing fixing tool

LOCK NUTS

Polyamide Hexagonal Lock Nuts

Metric Code	Size	Pack Qty	PG-Code	Size	Pack Qty
3420M16	M16	50	3420P07	PG7	100
3420M20	M20	50	3420P09	PG9	50
3420M25	M25	50	3420P11	PG11	50
3420M32	M32	25	3420P13	PG13.5	50
3420M40	M40	20	3420P16	PG16	50
3420M50	M50	10	3420P21	PG21	25
-	-	-	3420P29	PG29	20
-	-	-	3420P36	PG36	10
-	-	-	3420P42	PG42	10
-	-	-	3420P48	PG48	10

WIRING ACCESSORIES

WIRING ACCESSORIES

CABLE ACCESSORIES

Non-Insulated Terminals				For wire size 0.5-1mm			
NEW Packed per 100							
Code	MMF-1	M-250K	K-305	FL1-7A	BM1103	BM1104	BM1105
Size mm	6.35 x 0.8	6.35 x 0.8	6.35 x 0.8	6.35 x 0.8	Ø 3mm	Ø 4mm	Ø 5mm
Packed per 100							
Code	BM01002	BM01005	BM01009	BM01011	BM01013	BM01014	K12
Size mm	6.3 x 0.8	6.3 x 0.8	6.3 x 0.8	6.3 x 0.8	6.3 x 0.8	6.3 x 0.8	6.3 x 0.8



Nylon Bushing 10m Roll

Code 10m	Panel Thickness
AMB-1.2	1.0-1.4mm
AMB-1.6	1.4-1.8mm
AMB-2	1.8-2.2mm

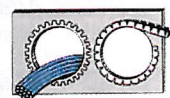

Spiroband (Polythene -60°C to +70°C)

Colour	Cable Ø	Roll length	Code
Natural	5-50mm	30m	GST-4
Natural	10-65mm	30m	GST-9
Natural	20-100mm	30m	GST-15

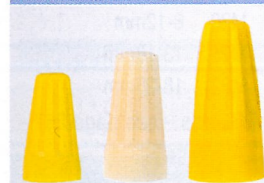

Wire Nuts Twist on wire connectors

Code	Colour	Size mm ²	Pack Size
S1	Yellow	0.5-1.5	100
M1	Ivory	0.5-2.5	100
L1	Yellow	1.0-4.0	100

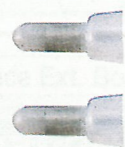

Closed End Connectors

Code	Size mm ²	Pack Size
HW-C3	0.5-1.75	100
HW-C4	1.0-3.0	100
HW-C5	2.5-6.0	100

Galvanised Steel Flexible Conduit



PVC Coated Steel Flexible Conduit



Brass



Aluminium Die Cast



For Lock Nuts see page 314

Size mm	Galvanised Code/5m	Galvanised Code/30m	PVC Coated Code/5m	PVC Coated Code/30m	Female Adaptor Brass	Male Adaptor Brass	Male Adaptor Alu. Die Cast
16	GFC-165	GFC-1630	PFC-165	PFC-1630	TC-BF16	TC-BM16	TC-AM16
20	GFC-205	GFC-2030	PFC-205	PFC-2030	TC-BF20	TC-BM20	TC-AM20
25	GFC-255	GFC-2530	PFC-255	PFC-2530	TC-BF25	TC-BM25	TC-AM25
32	GFC-325	GFC-3215 (15m)	PFC-325	PFC-3215 (15m)	TC-BF32	TC-BM32	TC-AM32

Flexible Coupling



90° Squeeze Connector



Connector



2-Piece Swivel Connector



20mm	M900-20	M901-20	M902-20	M903-20
25mm	M900-25	M901-25	M902-25	M903-25

NEW

LARGE SIZE TERMINALS

Nylon Insulated Pin Lug

Code	Size	Pin Length	Pack
BM00450	10mm ²	12mm	100
BM00550	16mm ²	13mm	100
BM00650	25mm ²	15mm	100

Insulation colour: Black

Uninsulated Pin Lug

Code	Size	Pin Length	Pack
LPL-10	10mm ²	12mm	100
LPL-16	16mm ²	13mm	100
LPL-25	25mm ²	15mm	100
LPL-35	35mm ²	20mm	100
LPL-50	50mm ²	25mm	50

CABLE ACCESSORIES

BM EASY ENTRY
VINYL INSULATED
75%

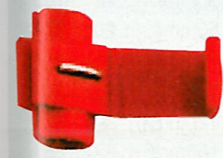
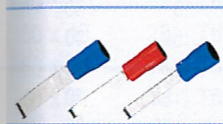
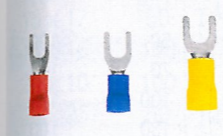

Pre-insulated lugs (per 100), *per 50

Description	Red 1.5mm ²	Blue 2.5mm ²	Yellow 4-6mm ²
Ring 3mm	BM00109	-	-
4mm	BM00119	BM00219	*BM00319
5mm	BM00125	BM00225	*BM00325
6mm	BM00131	BM00231	*BM00331
8mm	BM00137	BM00237	*BM00337
10mm	-	-	BM00343

Fork 3mm	BM00108	-	-
4mm	BM00120	BM00220	*BM00320
5mm	BM00126	BM00226	*BM00326
6mm	BM00132	BM00232	*BM00332

Pin 10mm	BM00151	BM00251	*BM00350
----------	---------	---------	----------

Blade 10mm	BM00152	BM00252	*BM00352
18mm	BV-4	BV-5	BV-6

Lipped 2.8mm	BV-128	BV-228	-
Blade 4.6mm	BV-146	BV-246	-

Ferrules	BM00160	BM00260	*BM00360
----------	---------	---------	----------

Male (6.3mm x 0.8mm)	BM00180	BM00280	*BM00380
Disconnectors (4.8mm x 0.8mm)	MV-1488	MV-2488	-
(2.8mm x 0.5mm)	MV-1288	MV-2288	-

Female (9.5mm)	-	-	*BM00383
Disconnectors (6.3mm)	BM00190	BM00290	BM00391
(4.8mm)	BM00148	BM00248	-
(2.8mm)	BM00395	FV-2288	-

Piggy Back	BM00198	*BM00298	FBV-5638
------------	---------	----------	----------

Fully insulated female (6.3mm) disconnectors	BM00191	BM00291	BM00392
--	---------	---------	---------

Male Bullet	BM00130	BM00230	BM00330
-------------	---------	---------	---------

Female Bullet	BM00140	BM00240	*BM00340
---------------	---------	---------	----------

Quick Splice Connectors

Code	Size	No. of Wires	Colour
M1.25	0.5-1.0mm	2	Red
M2	1.5-2.5mm	2	Blue
M5.5	4-6mm	2	Yellow

Push-in Wire Connectors (per 100)

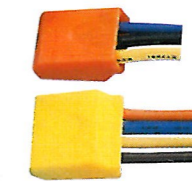

Code	Size	No of Wires	Colour
PC-3	0.5-1.5mm	3	Orange
PC-4	0.5-1.5mm	4	Yellow
PC-5	0.5-1.5mm	5	Grey
PC-8	0.5-1.5mm	8	Black

Non-insulated Ferrules



EXTENDED RANGE

Code	Pack	Size	Code	Pack	Size
F01.5	100	1.5mm ²	F35	100	35mm ²
F02.5	100	2.5mm ²	F50	50	50mm ²
F04	100	4mm ²	F70	50	70mm ²
F06	100	6mm ²	F95	20	95mm ²
F10	100	10mm ²	F120	10	120mm ²
F16	100	16mm ²	F150	10	150mm ²
F25	100	25mm ²	F185	10	185mm ²



Non-insulated Ring Lugs

Each	Code
35mm ² x 6mm	RL35X6
35mm ² x 8mm	RL35X8
35mm ² x 10mm	RL35X10
35mm ² x 12mm	RL35X12
Packs of 100	
Code	Code
1.5mm ² x 4mm	RL1.5X4
1.5mm ² x 5mm	RL1.5X5
1.5mm ² x 6mm	RL1.5X6
2.5mm ² x 4mm	RL2.5X4
2.5mm ² x 5mm	RL2.5X5
2.5mm ² x 6mm	RL2.5X6
2.5mm ² x 8mm	RL2.5X8
4mm ² x 5mm	RL4X5
4mm ² x 6mm	RL4X6
6mm ² x 5mm	RL6X5
6mm ² x 6mm	RL6X6
6mm ² x 8mm	RL6X8
10mm ² x 5mm	RL10X5
10mm ² x 6mm	RL10X6
10mm ² x 8mm	RL10X8
10mm ² x 10mm	RL10X10
16mm ² x 5mm	RL16X5
16mm ² x 6mm	RL16X6
16mm ² x 8mm	RL16X8
16mm ² x 10mm	RL16X10
16mm ² x 12mm	RL16X12
25mm ² x 6mm	RL25X6
25mm ² x 8mm	RL25X8
25mm ² x 10mm	RL25X10
25mm ² x 12mm	RL25X12

WIRING ACCESSORIES

WIRING ACCESSORIES

CABLE ACCESSORIES

Cable Ties

BLACK UV RESISTANT

KTC-110/210 with name tag **NEW**

KTC-100/200 GT Range

Code Black	Length mm	Width	Pack Size	Code Natural
GT100B	104mm	2.5	100	GT100N
GT140B	140mm	2.5	100	GT140N
GT150IB	150mm	3.5	100	GT150IN
GT200IB	200mm	3.6	100	GT200IN
GT200SB	205mm	4.7	100	GT200SN
GT300SB	305mm	4.7	100	GT300SN
GT390SB	395mm	4.7	100	GT390SN
GT300LB	280mm	7.8	100	GT300LN
GT370LB	395mm	7.8	50	GT370LN
KTC-100SB	100mm	2.5	100	KTC-100SN
KTC-200SB	200mm	2.5	100	KTC-200SN
KTC-110SB	110mm	2.5	100	KTC-110SN
KTC-210SB	210mm	2.5	100	KTC-210SN

Releasable Cable Ties

Code	Size L x W	Pack Size
RTC-150ML	150 x 7.6	100
RTC-200ML	200 x 7.6	100
RTC-250ML	250 x 7.6	100
RTC-300ML	300 x 7.6	100
RTC-370ML	370 x 7.6	100

Self adhesive cradles (natural)

Code	Size WxH	Pack Size
HW-3A	19 x 19	100
HW-4A	28 x 28	100

Bootlace Insulated Ferrules

Code 100 pcs	Code 500 pcs	Wire size	Colour	L
E0508-100	E0508-500	0.5mm ²	White	8mm
E7508-100	E7508-500	0.75mm ²	Blue	8mm
E1008-100	E1008-500	1mm ²	Red	8mm
E1508-100	E1508-500	1.5mm ²	Black	8mm
E2508-100	E2508-500	2.5mm ²	Grey	8mm
E4012-100	E4012-500	4mm ²	Orange	12mm
E6012-100	E6012-500	6mm ²	Green	12mm

Twin Bootlace Insulated Ferrules

Code 100 pcs	Code 500 pcs	Wire size	Colour	L
D0508-100	D0508-500	0.5mm ²	White	8mm
D7508-100	D7508-500	0.75mm ²	Blue	8mm
D1008-100	D1008-500	1mm ²	Red	8mm
D1508-100	D1508-500	1.5mm ²	Black	8mm
D2510-100	D2510-500	2.5mm ²	Grey	8mm
D4012-100	D4012-500	4mm ²	Orange	12mm
D6014-100	D6014-500	6mm ²	Green	12mm

Non-Insulated Bootlace Ferrules

Code	Wire Size	L	Pack Qty
CN0.5	0.50mm ²	8	100
CN0.75	0.75mm ²	8	100
CN1.0	1mm ²	8	100
CN1.5	1.5mm ²	8	100
CN2.5	2.5mm ²	10	100
CN4.0	4mm ²	10	100
CN6.0	6mm ²	12	100
CN10	10mm ²	15	100
CN16	16mm ²	15	100
CN25	25mm ²	18	100
CN35	35mm ²	18	100
CN50	50mm ²	20	50
CN70	70mm ²	25	50
CN95	95mm ²	25	50
CN120	120mm ²	30	25
CN150	150mm ²	32	25

Stainless Steel Cable Ties

BL & BLH type RT & RTH type

surelock

Non-releasable type (roller ball)

Size mm	Code S/S316 4.6mm (W)	Pack Qty	Code S/S316 7.9mm (W)	Max Bundle Dia	Pack Qty
200	BL200-46	100	BLH200-76	50	100
260	BL260-46	100	BLH260-76	70	100
360	BL360-46	100	BLH360-76	100	100
450	BL450-46	100	BLH450-76	130	100
520	BL520-46	100	BLH520-76	150	50
680	-	-	BLH680-76	200	50
840	-	-	BLH840-76	250	50

Stainless Steel Cable Ties S/S316 Releasable type

Size mm	Code 5.3mm (W)	Pack Qty	Code 9.5mm (W)	Max Bundle Dia	Pack Qty
152	RT152-66	30	RTH152-69	3	30
229	RT229-66	30	RTH229-69	58	30
305	RT305-66	20	RTH305-69	81	20
457	RT457-66	20	RTH457-69	132	20
610	-	-	RTH610-69	180	20

Stainless Steel Tags S/S316

Code	Size L x W	Pack Qty
EST51	51 x 19	100
EST63	63 x 38	100

Tensioning & Cutting Gun

Code: KP-156E

Application

Cable Tie Mount Saddle/100

Code	Size L x W x H	For Tie Width
TMS-15	15 x 10 x 7	5mm
TMS-22	22 x 16 x 9	9mm

Slotted trunking grey (2m lengths) L.A.P.

Blue type

Narrow Wide

*For blue narrow slot add B to code eg. (BT40X40)

Size WxH	Ctn/Qty	*Code Narrow Slot	Code Wide Slot	Spare Covers
12 x 8	100	-	-	-
12.5 x 12.5	50	-	-	-
15 x 10	50	-	-	-
15 x 17	50	T15X17	-	COV15
16 x 16	100	-	-	-
20 x 10	100	-	-	-
25 x 25	50	T25X25	TW25X25	COV25
25 x 40	50	T25X40	TW25X40	COV25
25 x 60	35	T25X60	TW25X60	COV25
25 x 80	28	T25X80	TW25X80	COV25
40 x 25	50	T40X25	TW40X25	COV40
40 x 40	35	T40X40	TW40X40	COV40
40 x 60	28	T40X60	TW40X60	COV40
40 x 80	20	T40X80	TW40X80	COV40
40 x 100	32	T40X100	TW40X100	COV40
60 x 40	25	T60X40	TW60X40	COV60
60 x 60	16	T60X60	TW60X60	COV60
60 x 80	18	T60X80	TW60X80	COV60
60 x 100	24	T60X100	TW60X100	COV60
80 x 40	20	T80X40	TW80X40	COV80
80 x 60	14	T80X60	TW80X60	COV80
80 x 80	15	T80X80	TW80X80	COV80
80 x 100	24	T80X100	TW80X100	COV80
100 x 40	28	T100X40	TW100X40	COV100
100 x 60	10	T100X60	TW100X60	COV100
100 x 80	12	T100X80	TW100X80	COV100
100 x 100	8	T100X100	TW100X100	COV100
120 x 80	8	T120X80	TW120X80	COV120

Flexible Slotted Trunking

NEW

Code Screw Fixing	Dimensions W x H x L mm	Packing Pcs
EC23402	16 x 16 x 500	84
EC23404	25 x 25 x 500	70
EC23406	40 x 40 x 500	50

Flex-Protecting Gland

Code	Cable Ø	Hole Size	Thread Size
MG12A-P-05B	3-5.3	12mm	M12x1.5
MG12A-P-08B	4.5-8	12mm	M12x1.5
MG16A-P-06B	4-7	16mm	M16x1.5
MG16A-P-10B	6-10	16mm	M16x1.5
MG20A-P-10B	6-11	20mm	M20x1.5

Solid trunking white (2m lengths)

*Hinged lid & self-adhesive bottom

Code C/W Cover	Ctn/Qty	Spare Covers
ST12X8	50	-
*ST12.5X12.5	50	-
ST15X10	50	COV15WH
ST16X16	50	-
ST20X10	50	-
ST25X25	20	COV25WH
ST25X40	20	COV25WH
ST40X25	20	COV40WH
ST40X40	10	COV40WH
ST40X60	10	COV40WH
ST40X80	10	COV40WH
ST60X40	10	COV60WH
ST60X60	10	COV60WH
ST80X40	10	COV80WH
ST80X60	10	COV80WH
ST75X75	6	COV75WH
ST100X60	6	COV100WH
ST100X75	4	COV100WH
ST100X100	4	COV100WH
ST120X80	4	COV120WH

Solid Trunking Dark Grey (2m lengths)

Code	Size (mm) W x H
SWD-2525	25 x 25
SWD-3333	33 x 33
SWD-4040	40 x 40
SWD-5050	50 x 50
SWD-6565	65 x 65
SWD-100100	100 x 100

Grommets (black rubber) (Per 100)

Diagram showing dimensions A, B, C, D, E for a grommet.

Code	A (mm)	B (mm)	C (mm)	D (mm)	E (mm)
DH-06	6.3	1.6	8.7	4.8	3.2
DH-08	7.9	1.6	11.1	5.6	4.8
DH-10	9.5	1.6	14.3	6.3	6.3
DH-11	11.1	1.6	15.9	6.3	7.9
DH-13	12.7	1.6	15.9	6.3	9.5
DH-16	15.9	1.6	20.6	7.1	12.7
DH-17	16.7	3.2	21.4	9.5	9.9
DH-22	22.2	1.6	28.6	7.1	15.9
DH-25	25.4	1.6	33.3	9.5	17.5

Polyamide Cable Gland with Strain Relief and Bending Protection IP54

Code	Size Metric	Cable Size Ø
1230M2011	M20	7-9mm
1230M2013	M20	8-12mm
1230M2521	M25	13-17mm
1230M3229	M32	19-24mm
CRS11	PG11	6-10mm
CRS16	PG16	10-13mm
CRS21	PG21	13-17.5mm

Plastic Rivets

Rivet Tool

Code	Size	Pack Qty	Tool Code
VRV40/60	4mm	100	VRI40
VRV60	6mm	100	VRI60

Hole Plugs pack of 100

Code	Mounting Hole	Code	Mounting Hole
HP-08/100	7.8mm	HP-19/100	19mm
HP-09/100	9.5mm	HP-22/100	22mm
HP-13/100	12.7mm	HP-25/100	25.4mm
HP-16/100	16mm	HP-30/100	30.5mm

• Material: Nylon 66 (UL 94V-2) • Colour: Black
• Maximum panel thickness for HP-08 is 1.8mm and for other items is 3.2mm

Self Drilling Screws

c/w cap. Max. 1.2mm Mild Steel

Code	Size (mm)	Pack Qty
V7900	4.2 x 13	500

CABLE ACCESSORIES

CABLE ACCESSORIES

Wire Markers (rolls of 1000)

	For wire 1.0-2.5	For wire 2.0-4.0	For wire 1.0-2.5	For wire 2.0-4.0
0	EC2-0	EC1-0	A to Z	EC2-*
1	EC2-1	EC1-1	*Add Letter of Alphabet	EC1-*
2	EC2-2	EC1-2		
3	EC2-3	EC1-3		
4	EC2-4	EC1-4		
5	EC2-5	EC1-5		
6	EC2-6	EC1-6		
7	EC2-7	EC1-7		
8	EC2-8	EC1-8		
9	EC2-9	EC1-9		
+	EC2-+	EC1-+		
-	EC2--	EC1--		

Carry Case

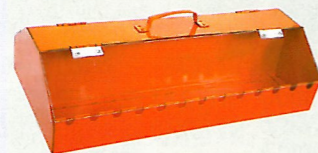

Code Description

DR-103 Carry case for 26 wire marker rolls

Insulation Tape 0.15mm thick
(fire retardant - self extinguishing)



KIPVC10

Code	Code	Colour
10m x 19mm(W)	20m x 19mm(W)	
IN-R	IN25-R	Red
IN-W	IN25-W	White
IN-BL	-	Blue
IN-BK	IN25-BK	Black
IN-G	-	Green

KIPVC10 (5 roll set) BK, R, BL, W, G

Heatshrink (Professional Grade Flexible Flame Retarded Polyolefin)

-55 to 135°C



Dielectric Strength
25kV/mm

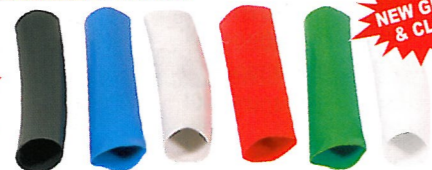

NEW GREEN & CLEAR



Self Amalgamating Tape
(High Voltage Insulating Tape)

Code	Description	Colour
INS-83	4.57m x 19mmW x 0.76mm	Black

Dielectric strength ≥ 40KV/mm
Conductor Insulation up to 69000V

Cable Jointing Kits

• Clear Epoxy Self Extinguishing for A350, all other polyurethane
• Rated Voltage 1.1KV

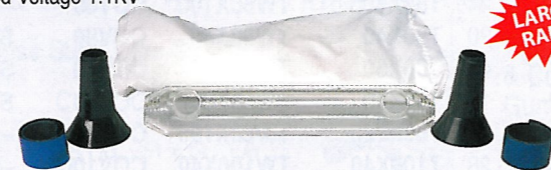

LARGER RANGE

Code	Cable Size Up to 4 Core	Diameter	Length
A350	4 x 4mm ²	6-15mm	185mm
A351	4 x 10mm ²	9-25mm	240mm
A352	4 x 16mm ²	15-23mm	270mm
A353	4 x 25mm ²	16-32mm	275mm
A354	4 x 35mm ²	23-38mm	310mm
A355	4 x 50mm ²	22-45mm	360mm
A356	4 x 70mm ²	30-50mm	400mm

Jointing Kits

for 1-3 core cables

Code	Size	Includes
HX-A	3 x 1.5mm ²	• 9 x Insulated Ferrules • 3 PCs Amalgamating Tape
HX-B	3 x 2.5mm ²	• 1 x Black and 2 x White Shrink Sleeving 130mm long

Resin Filled Cabtyre Joint Kit IP68

RFCJ-WH	3 x 1.5mm ²	• Resin filled joining kit
RFCJ-BK	3 x 2.5mm ²	• Max Ø8.5mm

Gel Type Joint Kit IP68 (Re-accessible)

MAGIC-1	70 x 200	for 1-2.5mm ² 3 core c/w 3 x 2.5mm ² Ferrules
MAGIC-4	160 x 450	for 1.5-4mm ² 2/3/4 core
MAGIC-10	180 x 500	for 1.5-10mm ² 2/3/4 core
MAGIC-25	215 x 550	for 4-25mm ² 2/3/4 core
MAGIC-35	232 x 700	for 16-35mm ² 2/3/4 core
MAGIC-50	266 x 720	for 16-50mm ² 2/3/4 core



MAGIC-1 no setting time



MAGIC-4/10/25/35/50

Junction Boxes IP66/68 (IEC60529)

Code	Gland size	Entry thread	Clear inside height	Clear inside Dia. Ø	Distance of fixing holes
102101	20mm	M20x1.5	57mm	94mm	122mm
102102	25mm	M25x1.5	59.5mm	124mm	150mm



*Add colour to code: ● R (Red), ○ WH (White), ● BL (Blue), ● BK (Black), ● GN (Green), ○ C (Clear)

BRASS BIFILAR CLAMPING LUGS

NEW

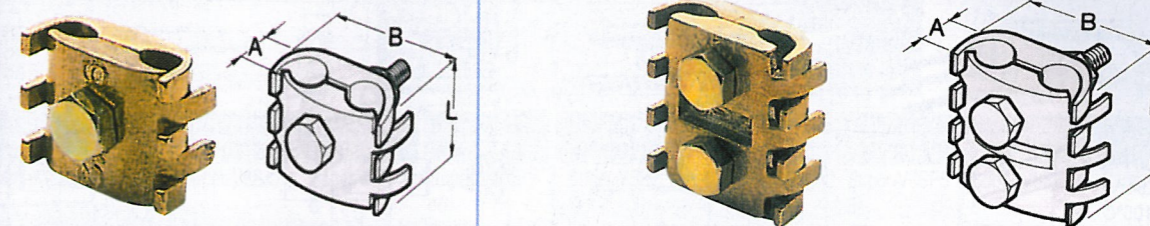

Code	BM5251	BM5252	BM5253	BM5261	BM5262	BM5263	BM5264	BM5265	BM5266
Wire Size (mm ²)	6-16mm ²	25-50mm ²	50-70mm ²	6-16mm ²	25-50mm ²	50-70mm ²	70-95mm ²	95-150mm ²	150-300mm ²
Conductor Ø	3-5mm	6-8mm	9-12mm	3-5mm	6-8mm	9-12mm	12-14mm	14-16mm	16-22mm
Dimension - A	5mm	9mm	12mm	5mm	9mm	12mm	14mm	16mm	22mm
Dimension - B	25.5mm	29.5mm	37.5mm	25mm	32mm	42mm	53mm	54.5mm	66mm
Dimension - L	20.5mm	25mm	30mm	32mm	38mm	45mm	53mm	57.5mm	67mm
Pack Qty	100	50	50	100	100	50	25	20	15

CABLE ACCESSORIES

Brass "C" Crimping Sleeve

NEW



Code	Wire Size (mm ²)	Pack Qty.	Code	Wire Size (mm ²)	Pack Qty.
BM01416	6 + 6mm ²	100	BM01411	70 + 35mm ²	25
BM01400	10 + 10mm ²	100	BM01405	70 + 70mm ²	25
BM01401	16 + 16mm ²	100	BM01412	95 + 35mm ²	25
BM01408	25 + 10mm ²	100	BM01406	95 + 95mm ²	25
BM01402	25 + 25mm ²	100	BM01413	95 + 70mm ²	25
BM01409	35 + 16mm ²	100	BM01407	120 + 120mm ²	25
BM01403	35 + 35mm ²	100	BM01414	150 + 120mm ²	25
BM01410	50 + 25mm ²	100	BM01415	185 + 95mm ²	25
BM01404	50 + 50mm ²	50			

Battery Terminals

NEW

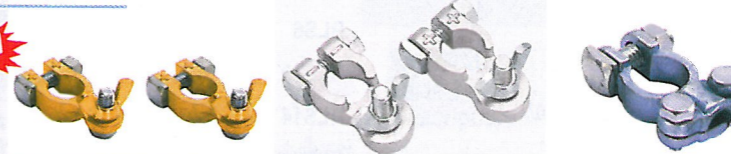

Code	JHC828-2	JHC462-2	JHC002-2
	Wing nut Marine brass Terminals P+N 2Pcs blister packed	Wing nut Terminals P+N Nickel plated 2Pcs blister packed	Universal zinc Terminal P+N 2Pcs blister packed

Code	JHC006B-2	JHC150-1 (1Pc) JHC150-2 (2Pc)
	Universal brass Terminal P+N 2Pcs blister packed	Standard universal Lead terminal 1 Pc or 2Pc blister packed

Nylon Screw Plugs

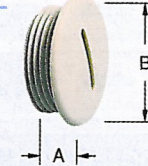

Code	Thread Size	Dimensions A	Dimensions B
SPG-M16G	M16 x 1.5	8	20
SPG-M20G	M20 x 1.5	8	25
SPG-M25G	M25 x 1.5	8.5	30

NEW PG-Type

Code	PG Size	Code	PG Size
SPG-PG11G	PG11	SPG-PG29G	PG29
SPG-PG13.5G	PG13.5	SPG-PG36G	PG36
SPG-PG16G	PG16	SPG-PG42G	PG42
SPG-PG21G	PG21		

High Voltage Cable Joints - Heat shrinkable

Suitable for use with XLPE/EPR/PVC Cables



	12kV		36kV	
mm ²	Code	mm ²	Code	
16-50	OEC-CXS-11	35-70	OEC-CXS-31	
70-95	OEC-CXS-12	95-150	OEC-CXS-32	
120-185	OEC-CXS-13	185-300	OEC-CXS-33	
240-300	OEC-CXS-14	400	OEC-CXS-34	
400-500	OEC-CXS-15			

Features

- Fits a wide dimensional range
- Simple and fast installation
- Excellent weather and UV resistance
- Exceptional insulation properties
- Kit includes easy to follow, step-by-step instructions

CRIMPING MULTIWAY CONNECTORS



- Current Rating: 15A
- Volts: 300V
- Housing Material: Nylon PA6.6 colour natural
- Self-extinguishing: UL94-V2
- Exercise Temp: -25 + 105°C
- Electric rigidity: 1500VAC - 1min
- Terminal Material: Tinned Brass

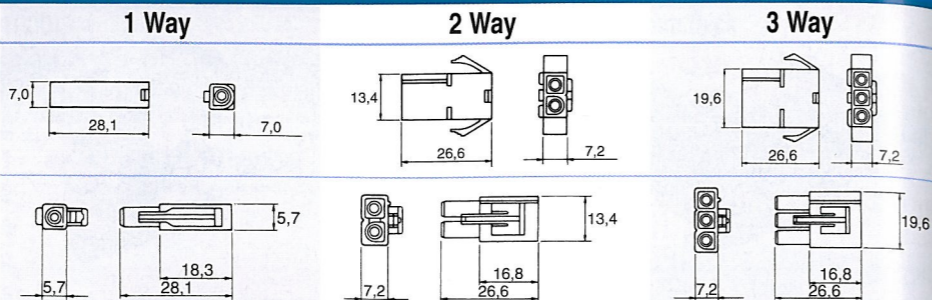

Code	Female	Male
	BM01041	BM01031
	BM01042	BM01032
	BM01043	BM01033

Extraction Tool

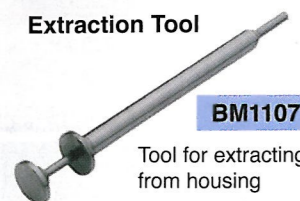

Tool for extracting Terminals from housing

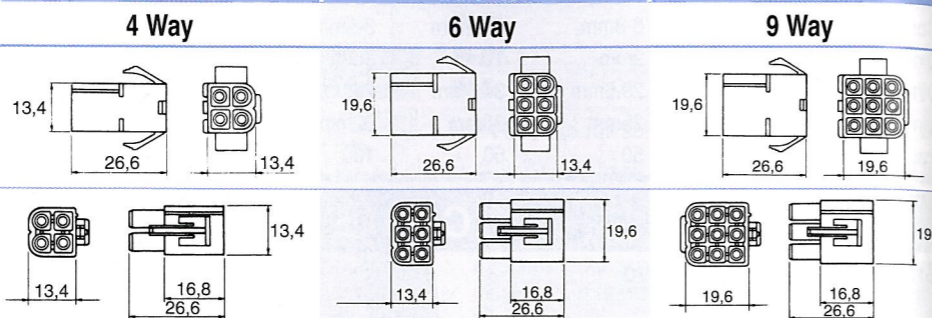

Code	Female	Male
	BM01044	BM01034
	BM01046	BM01036
	BM01049	BM01039

CABLE ACCESSORIES

Easy Cover • Material: Polyethylene Resin

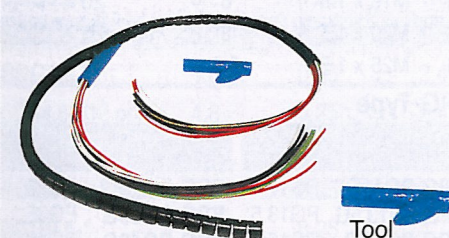

Braided Sleeving



Temperature - 50°C to 150°C

Size Ømm	Code		Tool	Code Black/polybag			
	Black/Roll	White/Roll		2m	3m	4m	5m
15	BK6015/50	WH6015/50	BK1015	-	BK6015/3	-	BK6015/5
20	BK6020/30	WH6020/30	BK1020	BK6020/2	-	BK6020/4	-
25	BK6025/20	WH6025/20	BK1025	BK6025/2	-	BK6025/4	-

• Tool to be ordered separately

• Supplied in a polybag c/w tool.

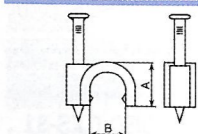

Round Cable Clips (white)

Code	Cable Size (mm) B x A		Pack Size
CCR-6	6	5-6	100
CCR-8	8	7-8	100
CCR-10	10	9-10	100
CCR-14	14	13-14	100
CCR-20	20	18-20 (For 20mm conduit)	100
CCR-25	25	23-25 (For 25mm conduit)	50



Flat Cable Clips (white) (100/pack)

Code	Twin Flat + E Size	Size (mm) A x B x H
CCF-5	-	5 x 3.8 x 6.0
CCF-6	-	6 x 4.1 x 6.5
CCF-8	1.5mm ²	8 x 5.0 x 7.5
CCF-10	2.5mm ²	10 x 5.7 x 8.2
CCF-12	4mm ²	12.5 x 5.7 x 8.2

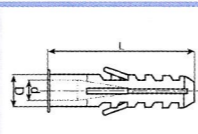

Nylon Plug (grey) (100/pack)

Code	Size (mm) D x d x L	Recommended Drill Size
EN-5	5 x 3.9 x 25	5mm
EN-6	6 x 4.9 x 29.8	6mm
EN-8	8 x 5.3 x 38.6	8mm
EN-10	10 x 5.8 x 42.7	10mm

NEW RANGE

WALL PLUGS

Super-V Universal Wall Plug



Code/Box	BMF0011/100	BMF0012/100	BMF0013/50	BMF0014/25	BMF0021/100	BMF0022/100	BMF0023/50	BMF0073/50	BMF0074/25	BMF0075/20
Code/BLP	BMF0011/10	BMF0012/10	BMF0013/10	BMF0014/5	BMF0021/10	BMF0022/10	BMF0023/10	BMF0073/5	BMF0074/5	BMF0075/5
Description	Super-V5S	Super-V6S	Super-V8S	Super-V10S	Super-V5SP	Super-V6SP	Super-V8SP5	Super-V8SE	Super-V10SE	Super-V12SE
D	5	6	8	10	5	6	8	8	10	12
A	25	30	40	50	25	30	40	40	50	60
B	35	40	50	70	35	40	50	50	65	75
d x C	4 x 30	4.5 x 40	5 x 50	6 x 60	4 x 30	1.5 x 40	5 x 50	5.5 x 45	6.5 x 60	7.5 x 70
E-Max	5	10	10	10	5	10	10	5	10	10

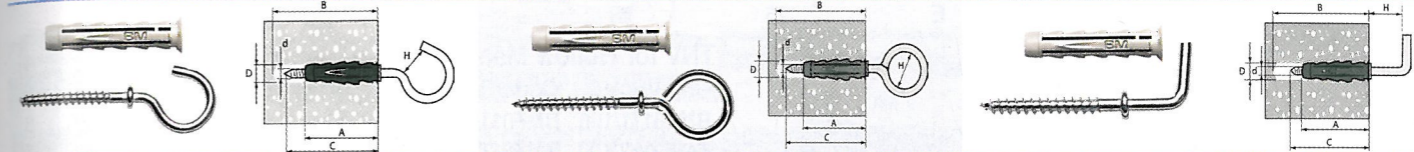

Code/Box	Description	D	A	B	d x C	H	Code/Box	Description	D	A	B	d x C	H
BMF0032/25	Super-V 6 GA	6	30	40	4.5 x 35	10	BMF0052/25	Super-V 6 GC	6	40	30	4.5 x 35	13
Code/BLP	BMF0032/5						Code/BLP	BMF0052/5					
							Code/BLP	BMF0042/5					

TNU Universal Wall Plug

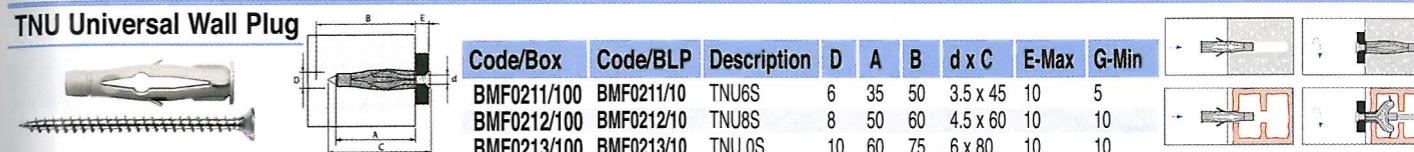

Code/Box	Code/BLP	Description	D	A	B	d x C	E-Max	G-Min
BMF0211/100	BMF0211/10	TNU6S	6	35	50	3.5 x 45	10	5
BMF0212/100	BMF0212/10	TNU8S	8	50	60	4.5 x 60	10	10
BMF0213/100	BMF0213/10	TNU0S	10	60	75	6 x 80	10	10

TN Universal Wall Plug



Code/Box	BMF0311/100	BMF0312/100	Code/Box	BMF0331/100	BMF0332/50	Code/Box	BMF0351/100	BMF0352/50
Code/BLP	BMF0311/5	BMF0312/5	Code/BLP	BMF0331/5	BMF0332/5	Code/BLP	BMF0351/5	BMF0352/5
Description	TN9S	TN12S5	Description	TN9GA	TN12GA9	Description	TN9GC	TN12GC
D	9	12	D	9	12	D	9	12
A	40	45	A	40	45	A	40	45
B	50	55	B	50	55	B	50	55
d	M4	M5	d	M4	M5	d	M4	M5
I	20	24	I	20	24	I	20	24
E	10	10	H	8	8.5	H	13	14

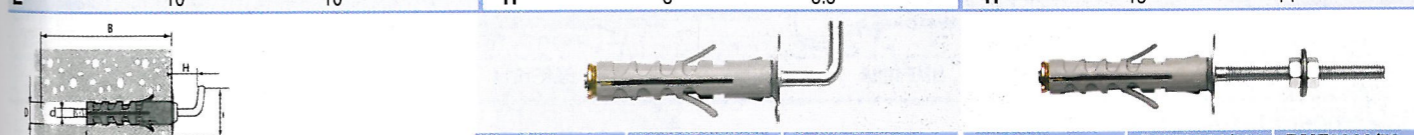

Code/Box	BMF0341/100	BMF0342/100	Code/Box	BMF0381/100	BMF0382/50
Code/BLP	BMF0341/5	BMF0342/5	Code/BLP	BMF0381/5	BMF0382/5
Description	TN9GM	TN12GM	Description	TN9DV	TN12DV
D	9	12	D	9	12
A	40	45	A	40	45
B	50	55	B	50	55
d	M4	M5	d	M4	M5
I	20	24	I	20	24
H	14	16	E	25	30

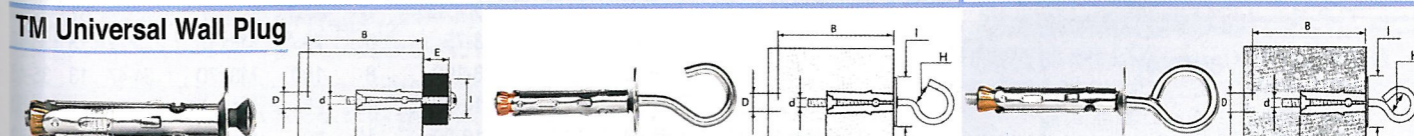

Code/Box	BMF0411/100	BMF0412/100	Code/Box	BMF0431/100	BMF0432/50	Code/Box	BMF0451/100	BMF0452/50
Code/BLP	BMF0411/5	BMF0412/5	Code/BLP	BMF0431/5	BMF0432/5	Code/BLP	BMF0451/5	BMF0452/5
Description	TM8S	TM9S	Description	TM8GA	TM9GA	Description	TM8GC	TM9GC
D	8	9	D	8	9	D	9	12
A	40	45	A	40	45	A	40	45
B	50	55	B	50	55	B	50	55
d	M4	M5	d	M4	M5	d	M4	M5
I	20	24	I	20	24	I	20	24
E	10	10	H	8	8.5	H	13	14

WIRING ACCESSORIES

WIRING ACCESSORIES

NEW RANGE

WALL PLUGS

TM Universal Wall Plug



Code/Box	Code/BLP	Code/Box	Code/BLP	Code/Box	Code/BLP	Code/Box	Code/BLP
BMF0441/100	BMF0441/5	BMF0442/100	BMF0442/5	BMF0481/100	BMF0481/5	BMF0482/50	BMF0482/5
TM8DV		TM9DV		TM8DV		TM9DV	
D	8	D	9	D	8	D	9
A	40	A	45	A	40	A	45
B	50	B	55	B	50	B	55
d	M4	d	M5	d	M4	d	M5
I	20	I	24	I	20	I	24
H	25	H	30	H	25	H	30

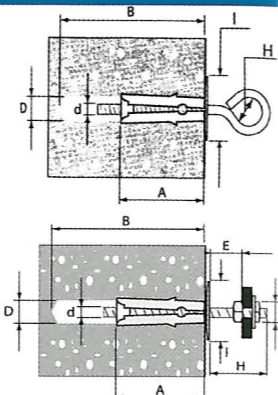

TNV for Hollow Material Fixing

Code/Box	Code/BLP	Description	D	A	B	d x C	E
BMF0111/100	BMF0111/10	TNV 6 S	6	36	55	3.5 x 50	5
BMF0112/100	BMF0112/10	TNV 8 S	8	50	65	4.5 x 60	5
BMF0113/100	BMF0113/10	TNV 10 S	10	60	75	5 x 70	5



AG Gravity Toggle

Code/Box	Code/BLP	Description	D	A	E	d x C	H
BMF1136/50	BMF1136/5	AG6GA	16	67	31	M6 x 70	12
BMF1186/50	BMF1186/5	AG6DV	16	67	31	M6 x 100	

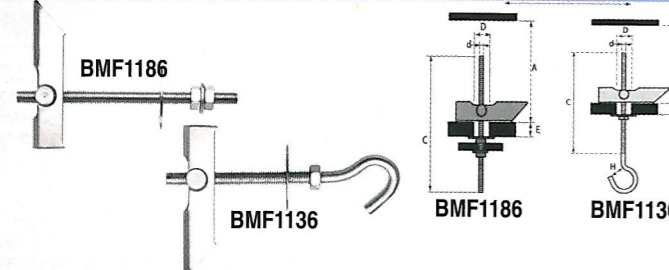

Spring Toggle AM

Code/Box	Code/BLP	Description	D	A	E	d	H
BMF1014/100	BMF1014/5	AM4S	14	34	30	M4 x 90	
BMF1034/100	BMF1034/5	AM4GA	14	34	30	M4 x 65	14
BMF1054/100	BMF1054/5	AM4GC	14	34	30	M4 x 65	

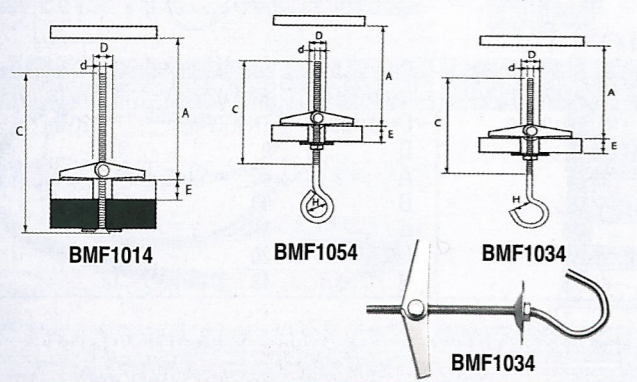

Plasterboard Fixing VP

Code/Box	Code/BLP	Description	A	E	d	Code/Box	Code/BLP	Description	A	E	d
BMF1311/100	BMF1311/5	VP S	38	12	4.5 x 35	BMF1411/100	BMF1411/10	VM S	38	12	4.5 x 30

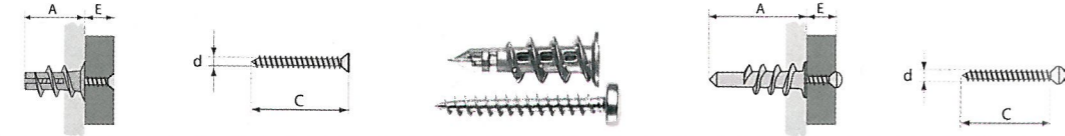

TPP - Anchor Bolt

Code/Box	Code/BLP	Description	D	A/B	d x C	E	F	G
BMF8003/50	BMF8003/10	TPP 8-75	8	75	M8x45	9-22	13	35-48
BMF8004/50	BMF8004/10	TPP 8-100	8	100	M8x70	34-47	13	35-48
BMF8005/50	BMF8005/10	TPP 10-75	10	75	M10x35	3-11	17	42-50
BMF8006/25	BMF8006/5	TPP 10-90	10	90	M10x45	18-26	17	42-50
BMF8007/25	BMF8007/5	TPP 10-120	10	120	M10x80	48-56	17	42-50
BMF8008/25	BMF8008/5	TPP 12-95	12	95	M12x40	7-17	19	50-70
BMF8009/20	BMF8009/5	TPP 12-110	12	110	M12x55	12-32	19	50-70
BMF8010/20	BMF8010/5	TPP 12-140	12	140	M12x90	52-62	19	50-70
BMF8011/10	BMF8011/2	TPP 16-125	16	125	M16x75	6-26	24	64-87
BMF8012/10	BMF8012/2	TPP 16-150	16	150	M16x100	31-51	24	64-87

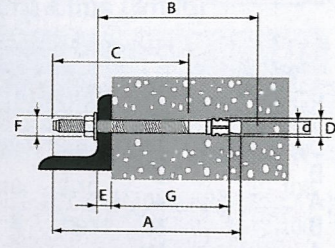

NB: the sum of dimensions E + G should be constant.
 Eg: If BMF8003 E=9, then G should be 48mm (tot = 57mm)
 If BMF8003 E=22, then G should be 35mm (tot = 57mm)

NEW RANGE

WALL PLUGS

Sleeve Anchor TMP

Code/Box	Code/BLP	Description	D	B	E	d x C	F	G
BMF3114/100	BMF3114/10	TMP 8-65	8	65	15	M6 x 65	10	40
BMF3116/150	BMF3116/10	TMP 8-90	8	90	40	M6 x 90	10	40
BMF3126/50	BMF3126/10	TMP10-65	10	65	10	M8 x 65	13	45
BMF3128/50	BMF3128/10	TMP10-90	10	90	35	M8 x 90	13	45
BMF3137/50	BMF3137/10	TMP12-75	12	75	10	M10 x 75	17	50
BMF3131/25	BMF3131/10	TMP12-115	12	115	50	M10 x 115	17	50

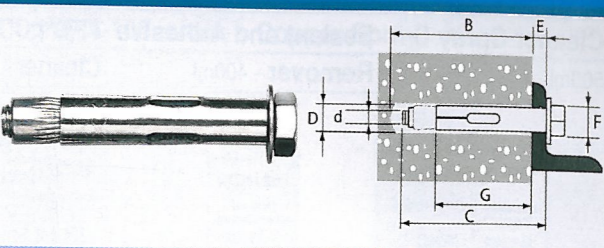

Heavy Duty Anchor TMN

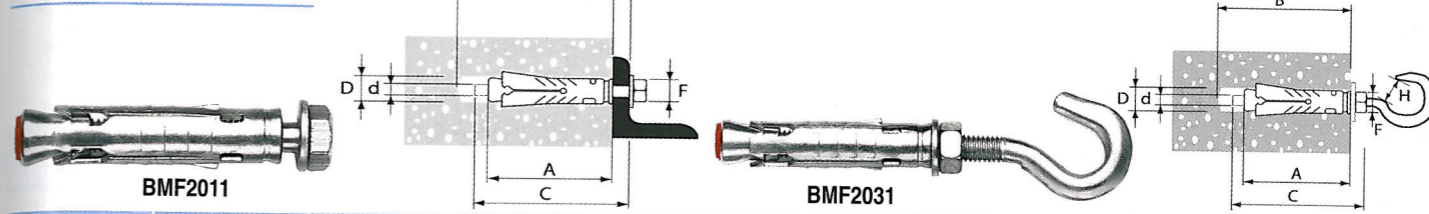

Code/Box	Code/BLP	Description	D	A	B	d x C	Code/Box	Code/BLP	Description	D	A	B	d x C	H	F
BMF2011/50	BMF2011/5	TMN 6 S	10	45	60	M6 x 55	BMF2031/50	BMF2031/5	TMN 6 GA	10	45	65	M6 x 70	5	10
BMF2012/25	BMF2012/5	TMN 8 S	12	50	65	M8 x 60	BMF2032/25	BMF2032/5	TMN 8 GA	12	50	80	M8 x 85	10	13
BMF2013/20	BMF2013/5	TMN 10 S	15	60	90	M10 x 85	BMF2033/10	BMF2033/5	TMN 10 GA	15	60	100	M10 x 105	20	17
BMF2014/10	BMF2014/5	TMN 12S	18	74	115	M12 x 105	BMF2034/5	BMF2034/2	TMN 12 GA	18	74	125	M12 x 130	25	19

CHEMICAL FIXING



Code	Description	Qty	Code/Box	Description	D	A	B	d
BMF9132	Cartridge RVE 150ml with adaptor piston and mixer	1	BMF9401/25	GN 12 x 50	12	50	55	M8
BMF9131	Cartridge RVE 280ml with mixer	1	BMF9402/25	GN 15 x 85	15	85	95	M10
BMF9201	Mixer for resin cartridge RVE	1	BMF9403/10	GN 15 x 130	15	130	140	M10
BMF9302	PST injection gun for resin RVE 280ml and RVE 150ml		BMF9404/10	GN 20 x 85	20	80	95	M12

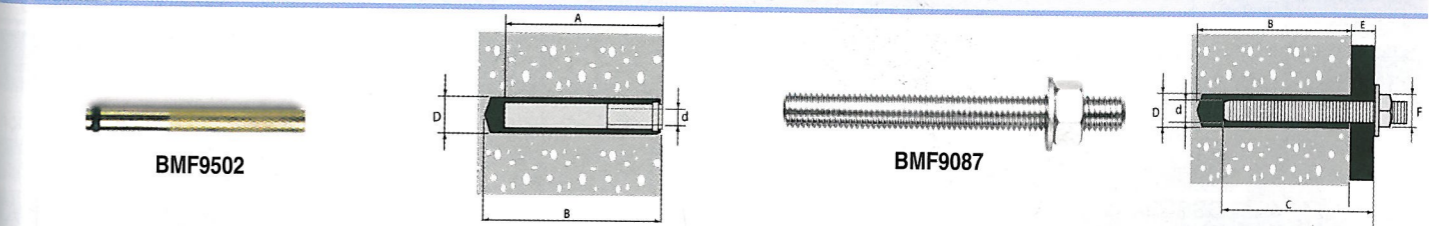

Code/Box	Code/BLP	Description	D	A	B	d	Code/Box	Code/BLP	Description	D	B	d x C	E	F
BMF9502/50	BMF9502/5	BFI 8	14	80	90	M8	BMF9082/50	BMF9082/5	BF M8 x 110	10	80	M8 x 110	10	13
BMF9503/25	BMF9503/5	BFI 10	16	80	90	M10	BMF9084/30	BMF9084/5	BF M10 x 110	12	90	M10 x 110	10	17
BMF9504/25	BMF9504/5	BFI 12	18	80	90	M12	BMF9085/30	BMF9085/5	BF M10 x 135	12	90	M10 x 135	35	17
							BMF9087/20	BMF9087/5	BF M12 x 115	14	110	M12 x 115	10	19

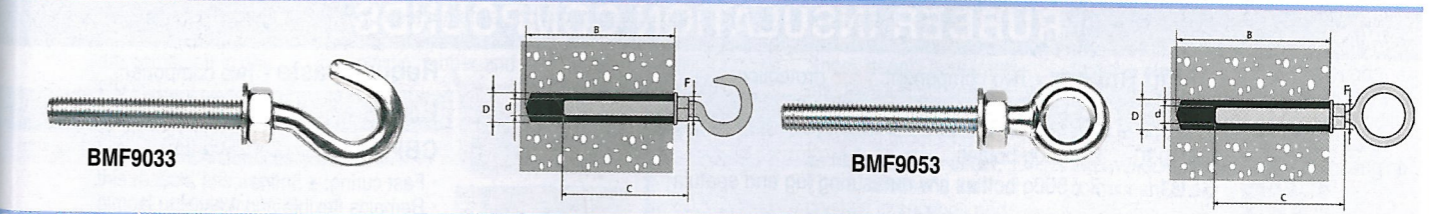

Code/Box	Code/BLP	Description	D	B	d x C	F	Code/Box	Code/BLP	Description	D	B	d x C	F
BMF9032/50	BMF9032/5	GFA 8	10	65	M8 x 60	13	BMF9052/50	BMF9052/5	GFO 8	10	65	M8 x 60	13
BMF9033/50	BMF9033/5	GFA 10	12	80	M10 x 73	17	BMF9053/25	BMF9053/5	GFO 10	12	80	M10 x 73	17
							BMF9054/15	BMF9054/5	GFO 12	14	95	M12 x 90	19

WIRING ACCESSORIES

WIRING ACCESSORIES

NEW RANGE

CLEANING AND DEGREASING

Cleaner Spray S - 500ml



WS-CS

Cleaner Spray S degreases and cleans all metals, glass, ceramics, and many plastics.

Applications:

- Cleaning and degreasing before priming and painting
- Before the use of other WEICON products, where a greasy substrate would impair the effect, eg. during adhesion
- Cleaning of machine parts

Cleaner Spray S evaporates quickly and works without residue. No residual layer remains as is the case when thinners is used. Even gummy lubricants are removed. Thermoplasts like PVC, plexiglass, polystyrene and simple paintjobs can be partially dissolved.

Sealant and Adhesive Remover - 400ml



WS-AR

Sealant and Adhesive Remover dissolves and quickly eliminates sealant and hardened adhesive residues, as well as lacquers and paints, without a problem, even on vertical surfaces.

Applications:

- Dissolves all types of sealant residues from cylinder heads, oil pans, water pumps, exhaust manifolds, valve covers and gear flangs.
- Reliably removes carbon residues, paints, and lacquers
- Eliminates oils, resins, greases and tar
- Used as paint remover in wood restoration
- Removes all kinds of adhesive, even hardened cyanoacrylate and anaerobically hardened adhesives.

Sealant and Adhesive Remover can be used on metal, wood, glass, ceramics, polyethylene and polypropylene. It should not be used with sensitive plastics like PVC, synthetics, linoleum, and so on.

TFT/ LCD Screen Cleaner - 200ml



WS-TFT

TFT/ LCD Screen Cleaner is the ideal product for the cleaning and care of sensitive plastic and glass surfaces. TFT/ LCD Screen Cleaner removes dirt, dust, grease, and nicotine and cleans carefully without leaving residues. Its antistatic effect provides a dirt and dust-repelling surface.

Applications:

- All kinds of thin film transistor and liquid crystal displays (eg. computers, notebooks, television sets, mobile phones, copiers, scanners, touch-screens).
- Plastic casings of computers, scanners, copiers or television sets.

Contact Spray - 400ml



WS-CC

Contact Spray is based on a special combination of active ingredients for the care and protection of electrical contacts and components. Disperses moisture from the electrical contacts, prevents leakage current and voltage loss and keeps contacts, fuses, cable connections, etc free of oxidation and sulphide deposits.

Applications:

- Penetrates and dispels moisture and water.
- Dissolves oxide deposits from contact points.
- Protects permanently against oxidation and corrosion.



Plastic Cleaner - 500ml



WS-PC

Plastic Cleaner is the ideal product for the cleaning and degreasing of sensitive surfaces.*

Applications:

- Cleaning and degreasing of:
 - Sensitive plastics like thermoplasts (PVC, PMMA = plexiglass, polystyrene, etc.) eg. window frames, roller blinds, plastic profiles
 - Rubber materials such as seals
 - Lacquered surfaces, such as powder-coated metal parts
- Removal of label and sticker residue.

* Check surface compatibility prior to use.

Compressed-Air Spray 400ml



WS-CA

Compressed-Air Spray can be used to remove dust, resistant to conventional cleaning methods. It permits dry, contact-free cleaning, even in inaccessible angles and on sensitive surfaces.

Hand-Protective Foam 200ml



WS-HP

Hand Protective Foam forms a greaseless, invisible, and water-resistant protective film that does not let various kinds of soiling penetrate the skin and pores. This 'invisible glove' protects against hazardous substances and irritants from aggressive chemical substances, the care effect is considerably improved

INSULATION GELS

Insulation Gel - Two component. IP68 protection.

Code	Description
GSB030	2 x 150g bottles
GSB1	2 x 500g bottles c/w measuring jug and spatula

- Re-accessible
- Fast setting: 10mins @20°C
- Suitable for installations up to 1kV
- Dielectric strength: 20kV/mm
- Sets even at low temperature

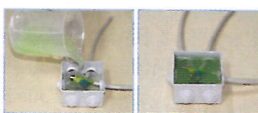

Insulation Gel - Ready to use IP68 protection.

Code	Description
GSM030	300g tub
GSM1	1kg tub

- Re-accessible & reusable
- One component ready to use
- Especially useful for vertical installations
- Totally transparent
- Excellent dielectric properties



RUBBER INSULATION COMPOUNDS

Liquid Rubber - Two component. IP68 protection.

Code	Description
GLB030	2 x 150g bottles
GLB1	2 x 500g bottles c/w measuring jug and spatula

- Fire-resistant
- Fast setting: 10mins @20°C
- Suitable for installations up to 1kV
- Dielectric strength: 20kV/mm
- Sets even at low temperature



Rubber Paste - Two component.

Code	Description
GBP050	2 x 250g tubs

- Fast curing: ± 5mins
- Remains flexible and elastic
- Non-toxic, re-accessible and mouldable
- Fire-resistant
- Application: Protection of joints
Custom cable break-outs
Sealing of junction boxes



NEW RANGE

SURFACE & CORROSION PROTECTION

Zinc Spray - 400ml



Code

WS-ZS

Zinc Spray offers quick-drying corrosion protection with a long-term effect for all metals.

Applications:

- As high-quality rust-protection primer.
- For touching-up welded or drilled sections.
- As a conductive intermediate layer in spot-welding.
- Wherever metal must be protected from corrosion.

In addition to the above-mentioned applications, Zinc Spray "Bright Grade" is preferred for the repair of damaged zinc coatings in the same colour.

Zinc Spray "Bright Grade" 400ml



WS-ZSB

Aluminium Spray A-100 - 400ml



WS-ALU

Aluminium Spray contains aluminium pigments with a purity grade of > 99.5% and offers high quality corrosion protection for all metallic surfaces. Aluminium Spray WS-ALU is abrasion-resistant.

Applications:

- In refrigeration & ventilation technology
- In combustion plants.
- In pipelines and machine housings.
- In exhaust systems (only on end pipes)
- On fibre-glass car body parts.
- In model construction, applied art, and toy manufacturing.

Copper Spray - 400ml



WS-COP

Copper Spray is a high-quality, weather-resistant, highly adhesive metal spray for protective and decorative coatings, with an effective nonferrous metal character for indoor and outdoor use. It is even used for the optical refinement (copper-plating) of various metal surfaces or design parts.

Applications:

- Sheet metal window sills.
- Roof gutters and drainage pipes.
- Outdoor lights and mailboxes.
- Craftwork and decorating.

LUBRICATING AND MULTIFUNCTIONAL OILS

W44 Turbo-Power Spray - 400ml



Code

WS-W44

WS-W44 covers a wide range of industrial and maintenance applications.

Due to its special formula and excellent creep properties, corrosion protection, water-resistance, lubrication, preservation, and cleaning are combined in one product. WS-W44 offers good protection against atmospheric influences. For this reason, it is used almost unlimitedly in the areas of workshops, automobiles, shipping, electrical systems, agriculture, household and hobbies.

Silicone Spray - 400ml



WS-SS

Silicone Spray is an ideal lubricant and separating agent for rational production and servicing. At the same time, it assumes the function of a preservative and care product for plastic, rubber and metal.

AT-44 Allround Spray with PTFE 400ml



WS-AT44

WS-AT44 Allround Spray with PTFE is used in all industrial and workshop areas. Due to its special formula and its very low coefficient of friction resulting from the high percentage of PTFE, corrosion protection, cleaning, water-resistance, lubrication, and conservation are combined in one product.

Rust-Shock - 400ml



WS-RS

Rust-Shock, the "chemical screwdriver" loosens all kinds of rusted screw connections: it works within seconds due to its two-fold function:

- The special composition of the materials generates a "chill effect" on the corroded workpiece. Rust-Shock deeply penetrates into these small spaces created by this cold shrinking process due to its high capillary effect.
- There, it loosens the rust crystals in seconds and thus neutralises the connection between the rust layers.

Freeze Spray - 400ml



WS-FS

Freeze Spray has many uses, eg. fault-finding in electronics as well as repair and maintenance in industrial sectors.

Applications:

Assembly pieces made of metal such as ball-bearings, bushes, chain-links, shafts etc can be fitted in closest fits with Freeze Spray. Thermal overloading faults in electrical circuits are found easily through local freezing. Useful also for maintenance works in the field of production and repair as well as in motor mechanics (eg. cooling of engine components).

Freeze Spray quickly cools parts down to -45°C and allows pin-pointed chilling of even the smallest parts. Freeze Spray is non-conductive and is suitable for any material (except plastics).

WIRING ACCESSORIES

WIRING ACCESSORIES